



LIFTING

Lifting Solution Specialist

HF Lifting d.o.o./Hidraulika-Flex d.o.o./Hidraulika - flex SA d.o.o.

Lighten Your Load With LIFTING



ABOUT US:

The company HF LIFTING d.o.o. Belgrade was founded in April 2023 and has specialized in the sale, servicing, and production of equipment for lifting, handling, and securing (lashing) all types of loads.

This company is fully aligned with its partner company in Bosnia and Herzegovina, Hidraulika-Flex d.o.o., headquartered in Laktaši.

Hidraulika-Flex d.o.o. was established in 2004 and is engaged in the production of metal components for both domestic and international markets, as well as in the manufacturing and sale of hydraulic and industrial hoses with fittings, and lifting equipment.

Through the dedicated efforts of its management and employees, along with continuous investment in new ideas, plans, certifications, products, and services, Hidraulika-Flex has become one of the leaders in the production and distribution of goods and services within its product range, which consists of four main groups:

- **CNC turning and milling** – manufacturing of special tools and components,
- **Hydraulic and industrial hoses and equipment** – production, sales, and servicing of brands such as HIDRAULIKAflex, HIDRAX, IVG, ZEC, IPL, LUDECKE, etc.,
- **Lifting equipment** – production, sales, and servicing of brands such as HF LIFTING, PEWAG, YALE, HAS Çelik, USHA MARTIN, etc.,
- **Protective chains** – sales and servicing of the PEWAG brand.

The company currently employs around 120 qualified workers, mostly with mechanical engineering backgrounds, whose knowledge and experience enable them to meet all market demands.

Throughout all business operations, Hidraulika-Flex, as well as its partner companies, places special emphasis on standardized operations and environmental protection, and belongs to the group of socially responsible companies. This is confirmed through certifications according to **ISO 9001, ISO 14001, and ISO 17025** standards.

With the aim of improving its operations and organizational structure, the company in 2024 accredited a laboratory for mechanical testing of steel wire, wire ropes, and slings in accordance with the **ISO/IEC 17025** standard and has initiated the process of extending its testing methods.

The laboratory provides testing services for the Hidraulika-Flex production facility in Laktaši, as well as for partner companies HF LIFTING d.o.o. Belgrade and HIDRAULIKA FLEX SA d.o.o. Sarajevo, in addition to external clients.

The advantages of working with an accredited laboratory are significant for potential clients and are reflected in internationally recognized technical competencies.

Today, it can be stated with confidence that Hidraulika-Flex d.o.o., together with its partner companies, belongs to the group of enterprises whose successful operations contribute to the development of the economy in the region.



CERTIFICATE

Certificate 774100

The management system of
HF LIFTING DOO
BEOGRAD (PALILULA), PANČEVAČKI PUT 104D, SRBIJA

has been assessed and certified as meeting the requirements of
ISO 45001:2018

For the following activities
Sale and service of equipment for lifting, securing and transferring loads such as chain slings, textile slings, cables and cable slings, traverses, cranes, load grabs, safety chains, snow chains.

Promet i servis opreme za podizanje, osiguranje i prenos tereta kao što su lančane priveznice, tekstilne priveznice, sajle i priveznice od sajli, troverze, dizalice, hvatačike za terete, zaštitni lanci za sneg.

This certificate is valid from 20 Oct 2023 until 20 Oct 2026 and remains valid subject to satisfactory surveillance audits.
1st Surv. Due on: 20 Oct 2024 | 2nd Surv. Due Before: 20 Oct 2025

Authorized by

The Certification International
18400 Holliston Blvd, Suite 508,
Torrance, CA 90504, USA
www.thecertification.org

Certificate 554112

The management system of
HF LIFTING DOO
BEOGRAD (PALILULA), PANČEVAČKI PUT 104D, SRBIJA

has been assessed and certified as meeting the requirements of
ISO 14001:2015

For the following activities
Sale and service of equipment for lifting, securing and transferring loads such as chain slings, textile slings, cables and cable slings, traverses, cranes, load grabs, safety chains, snow chains.

Promet i servis opreme za podizanje, osiguranje i prenos tereta kao što su lančane priveznice, tekstilne priveznice, sajle i priveznice od sajli, troverze, dizalice, hvatačike za terete, zaštitni lanci, lanci za sneg.

This certificate is valid from 20 Oct 2023 until 20 Oct 2026 and remains valid subject to satisfactory surveillance audits.
1st Surv. Due on: 20 Oct 2024 | 2nd Surv. Due Before: 20 Oct 2025

Authorized by

The Certification International
18400 Holliston Blvd, Suite 508,
Torrance, CA 90504, USA
www.thecertification.org

MAKS

CERTIFICATE

The management system of
HF Lifting DOO
Belgrade, Žitna 28, Dobanovci, Serbia



has been assessed and certified as meeting the requirements of
ISO 9001:2015

For the following activities
Proizvodnja, prodaja i servis opreme za podizanje i osiguranje tereta (čeličnih užadi, priveznica od čeličnog užeta, lanaca i lančanih priveznica, poliester priveznica, lančanih dizalica ručnih i električnih, električnih i ručnih dizalica sa čeličnim užetom, povlačnih dizalica/vitla sa čeličnim užetom, hvatačiki, paletera, hidrauličnih dizalica i komponenti za priveznice: karika, kuka, škopaca, zabica, španera i okretnih vijaka).

Production, sales, and servicing of lifting and load securing equipment (steel wire ropes, steel wire rope slings, chains and chain slings, polyester slings, chain hoists – manual and electric, electric and manual hoists with steel wire rope, pulling hoists/winchies with steel wire rope, clamps, pallet trucks, hydraulic jacks, and sling components: links, hooks, clamps, wire rope clips, turnbuckles – load binder, and swivel bolts).

This certificate is valid from 05 Jun 2025 until 05 Jun 2028 and remains valid subject to satisfactory surveillance audits.
1st Surv. Due on: 05 Jun 2026 | 2nd Surv. Due Before: 05 Jun 2027
Certificate Registration No: 77550124

Authorized by

Hader Ewa

MAKS GENERAL TRADING LLC | Office 43-44 - Al-Fahid, Dubai Municipality | Dubai, United Arab Emirates
www.maks-generaltrade.com | office@maks-generaltrade.com

CERTIFICATE

The Certification Body
of TÜV SÜD Landesgesellschaft Österreich GmbH
certifies that

HIDRAULIKA – FLEX D.O.O. LAKTAŠI
JOVANA CVIJIĆA BR. 3
BIH – 78250 LAKTAŠI

has established and applies
a Management System for

**Production of metal parts with CNC turning and milling;
Production and trade of hydraulic and industrial pipes with couplings;
Production and trade of equipment for carrying cargo**

An audit was performed and proof has been furnished that the requirements according to

ISO 9001 : 2015 and ISO 14001 : 2015
are fulfilled. The certificate is valid from 2025-01-01 until 2027-12-31.
Certificate Registration No. QU1530710 / 18

 
Vienna, 2024-12-30



Certification Body
of TÜV SÜD Landesgesellschaft Österreich GmbH
Franz-Grill-Straße 1 · Arsenal, Objekt 207, 1030 Vienna, Austria



BOSNA I HERCEGOVINA
BOSNIA AND HERZEGOVINA
INSTITUT ZA AKREDITOVANJE BOSNE I HERCEGOVINE
INSTITUTE FOR ACCREDITATION OF BOSNIA AND HERZEGOVINA

BATA
ACCREDITATION
EA MLA potpisnik
EA MLA signatory

Na osnovu člana 9. Zakona o akreditovanju Bosne i Hercegovine izdaje se
In accordance of article 9. of Law on Accreditation of Bosnia and Herzegovina it is issued

SERTIFIKAT O AKREDITACIJI
ACCREDITATION CERTIFICATE

kojim se potvrđuje da
confirming that

"Hidraulika-flex" d.o.o. Laktaši
Laboratorija za mehaničko ispitivanje čelične žlice, užadi i priveznica
Jovana Cvijića br. 3
78250 Laktaši

Ispunjava zahtjeve standarda BAS EN ISO/IEC 17025:2018 u pogledu osposobljenosti
za obavljanje ispitivanja.
Complies with requirements of BAS EN ISO/IEC 17025:2018 for competence
to carry out testing.

Detalji o području akreditacije, kao i ostali podaci značajni za akreditaciju,
dati su u dodatku, koji čini njen sastavni dio.
Details of accreditation scope, as well as other data relevant for the accreditation,
are specified in the Annex, that is its integral part.

Broj akreditacije
Accreditation number
LJ – 34 – 01
(Prva akreditacija / Initial accreditation: 21.01.2010.)

Akreditacija važi do
Accreditation is valid until
20.01.2028.

Sarajevo, 05.08.2024.



Direktor / Director
mr.sc. Dražan Primorac

INDEX

MANUAL HOISTING EQUIPMENTS

Chain Hoist	01
Lever Hoist	06
Push & Geared Trolley	10
Beam Clamp	11
Lifting Clamp	12
Magnetic Lifter	18
Crane Scale	19
Wire Rope Pulling Hoist	21
Hand Winch	23
Hand Puller	24

ELECTRIC HOISTING EQUIPMENTS

Electric Chain Hoist	25
Electric Trolley	27
Electric Wire Rope Hoist With Trolley	29
Electric Wire Rope Hoist	30
Electric Winch & Crane Accessories	36

TEXTILE SLING & HEIGHT SAFETY

Flat Woven Webbing Sling EN1492-1	37
Roundsling EN1492-2	38
Roundsling Assembly	40

TRANSPORT & LOAD RESTRAINTS

Ratchet Strap EN12195-2	41
Corner Protector	43
Load Binder	44
Grade 80 Lashing Chains with Load Binder	46
Grade 100 Ratchet Load Binder	47

LIFTING CHAIN, CHAIN SLING & COMPONENTS

Grade 80 Chain Sling	49
Grade 80 Lifting Chain	54
Grade 80 Sling Components	56
Grade 100 Lifting Chain	74
Grade 100 Chain Sling	75
Grade 100 Sling Components	78

WIRE ROPE, WIRE ROPE SLING & COMPONENTS

Wire Rope	93
Wire Rope Sling	134
Wire Rope Clip	139
Wire Rope Thimble	141
Wire Rope Grip	142
Wire Rope Ferrule	142
Wire Rope Socket	143

FORESTRY AND RIGGING HARDWARE

Forestry Wire Rope and Chains	145
Turnbuckle	152
Eye Bolt	155
Eye Nut	156
Shackle	157
Commercial Chain	164

MATERIAL HANDLING EQUIPMENTS

Moving Skate & Rack Jack	165
Hand Pallet Truck	166
Toe Jack	167
Bottle Jack	168
Farm Jack	169
Crane Fork & Engine Crane	170

CHAIN HOIST

Manual Hoisting Equipments

Electric Hoisting Equipments

Textile Sling and Height Safety

Transport and Load Restraints

Lifting Chain/Chain Sling/Components

Wire Rope/Wire Rope Sling/Components

Forestry and Rigging Hardware

Material Handling Equipments



CHAIN HOIST CH-B TYPE

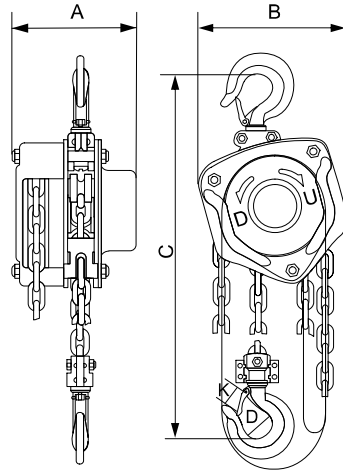

0.5t -2t

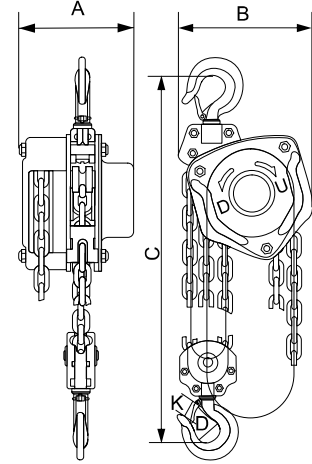

3t, 5t

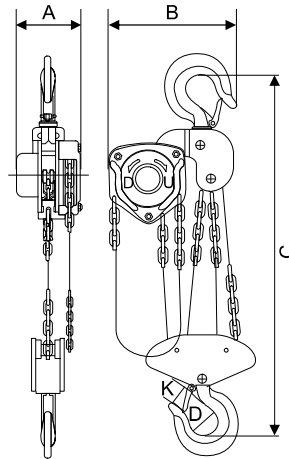

10t

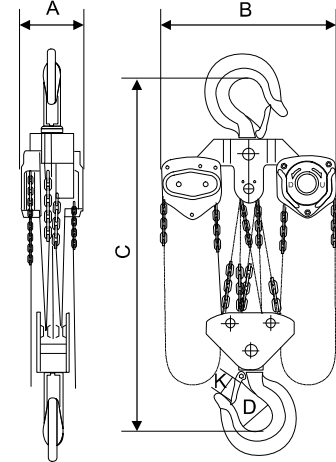

20t-50t

Item No.	Capacity	Standard Lift	Proof Load	Effort Required to Lift Rated Load	No. of Falls of Load Chain	Load Chain	Dimensions(mm)					N.W.	Extra Weight per Metre	Product Code
	t	m	kN	N		mm	A	B	C	D	K			
CHB0.5T	0.5	3	7.35	200	1	6x18	137.5	137	270	35	28	9.5	1.6	
CHB1.0T	1	3	14.7	320	1	6x18	146.5	162	340	35.5	26	11.6	1.6	
CHB1.5T	1.5	3	22.1	360	1	8x24	170	183	399	45	32.5	16.3	2.2	
CHB2.0T	2	3	29.4	365	1	8x24	170	194	414	42.5	32	18	2.2	
CHB3.0T	3	3	44.1	385	2	8x24	170	220	512	50	37	24.3	3.6	
CHB5.0T	5	3	73.5	435	2	10x30	190	288	636	64	46	38.7	5.2	
CHB10.0T	10	3	147	435	4	10x30	190	384	743	85	50	78	9.5	
CHB20.0T	20	3	245	435X2	8	10x30	209	625	890	110	81	163.6	19	
CHB30.0T	30	3	367.5	435X2	12	10x30	312	691	1380	110	81	220	27.7	
CHB50.0T	50	3	612.5	435X2	22	10x30	496	958	2578	170	125	1092	49.4	

Remarks: Hoists with the lift in other length are also available.

CHAIN HOIST CH-B TYPE

Features:

- Light weight robust construction.
- Automatic double pawl braking system.
- Extra thick asbestos-free friction discs.
- Drop forged alloy hooks are designed to stretch when overloaded before chain failure and are equipped with integrated heavy duty safety latch.
- High grade alloy steel load chain and zinc plated hand chain.
- Each hoist is proof tested at 1.5 times the rated capacity for rated capacities less than 20t and 1.25 the rated capacity equal to or greater than 20t.
- Complies with EN13157, ASME B30.16, AS1418.2, SANS 1594.
- Overload protection(optional).
- Bottom hook with bearing(optional).
- Chain bag (optional).
- Needle roller bearing between load sprocket and side plates (optional).



CHAIN HOIST

 Manual Hoisting
Equipments

 Electric Hoisting
Equipments

 Textile Sling and
Height Safety

 Transport and
Load Restraints

 Lifting Chain/Chain
Sling/Components

 Wire Rope/Wire Rope
Sling/Components

 Forestry and
Rigging Hardware

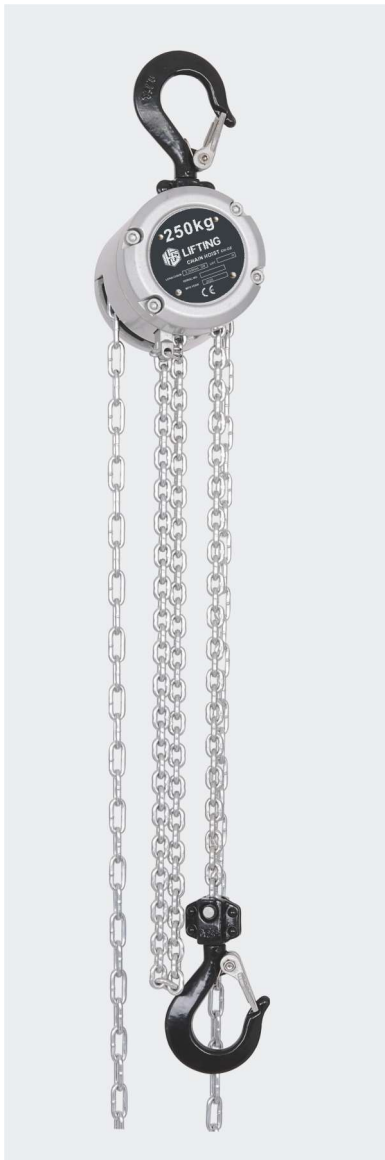
 Material Handling
Equipments

MINI CHAIN HOIST CH-DZ TYPE, ALUMINIUM BODY

Features:

- Extremely light weight aluminium housing.
- The hooks are suitable for a larger intake and its compact measures enable maximum lifting height.
- Flush-mounted screws at the housing.
- Comes with zinc-plated load chain.
- Each hoist is proof tested at 1.5 times the rated capacity.
- Complies with EN13157, ASME B30.16, AS1418.2, SANS 1594.
- Chain bag (optional).

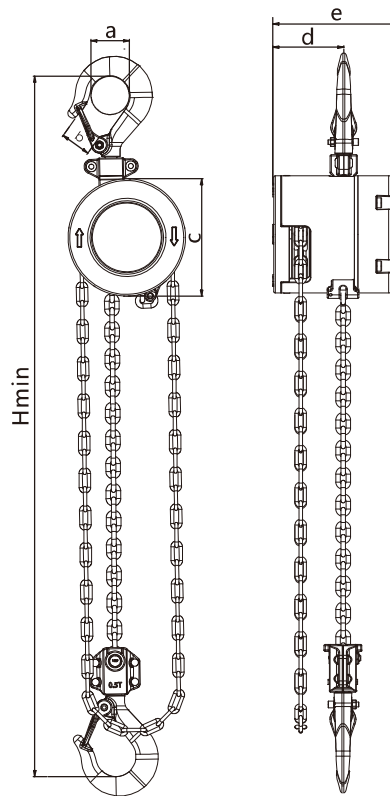

Item No.	Capacity	Standard Lift	Proof Load	Effort Required to Lift Rated Load	No. of Falls of Load Chain	Load Chain	Dimensions(mm)						N.W.	Extra Weight per Metre	Product Code
	kg	m	kN	N		mm	a	b	c	d	e	Hmin			
CHDZ0.25T	250	2.5	3.68	210	1	3.2X9	27	20	82	45	102	233	2.4	0.57	
CHDZ0.50T	500	2.5	7.35	230	1	4X12	34	22	104	63	110	307	3.9	0.68	
CHDZ1.0T	1000	2.5	14.7	250	2	4X12	44	30	104	63	110	380	6.5	1.02	

Remarks: Hoists with the lift in other length are also available.

CHAIN HOIST

STAINLESS STEEL CHAIN HOIST CH-SS TYPE

Features:

- Suitable for highly corrosive environments or dust-free rooms.
- Stainless steel construction.
- Forged stainless steel hooks.
- Stainless steel hand and load chain.
- Stainless steel nameplate.

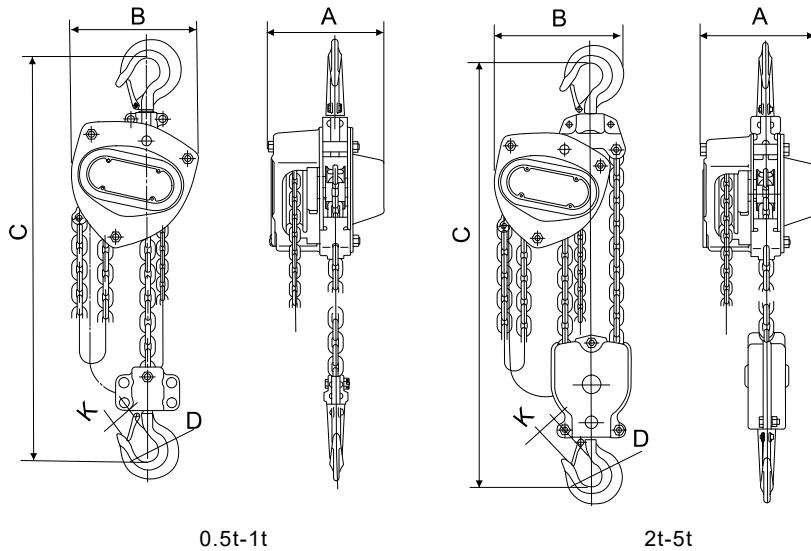
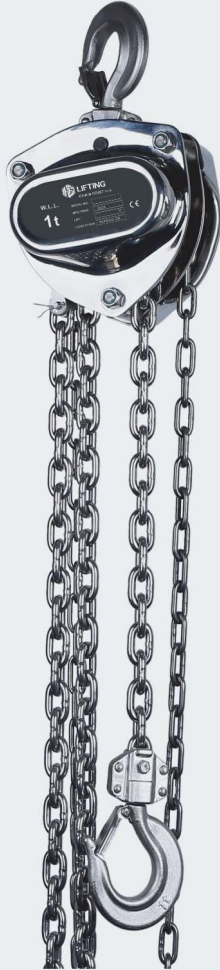

Item No.	Capacity	Standard Lift	Proof Load	Effort Required to Lift Rated Load	No. of Falls of Load Chain	Load Chain	Dimensions(mm)					N. W.	Extra Weight per Metre	Product Code
	t	m	kN	N		mm	A	B	C	D	K	kg	kg	
CHSS0.5T	0.5	2.5	7.35	290	1	6X18	131.5	142	360	40	26	10	1.65	
CHSS1.0T	1	2.5	14.7	366	1	7X21	151	172	376	40	26	13	1.97	
CHSS2.0T	2	2.5	29.4	428	2	7X21	151	192	425	50	34	19.5	3.1	
CHSS3.0T	3	3	44.1	418	2	10X30	173	230	565	55	39	31.5	4.37	
CHSS5.0T	5	3	73.5	400	3	10X30	189	365	710	65	41	60	7.3	

Remarks: Hoists with the lift in other length are also available.

Manual Hoisting
Equipments

Electric Hoisting
Equipments

Textile Sling and
Height Safety

Transport and
Load Restraints

Lifting Chain/Chain
Sling/Components

Wire Rope/Wire Rope
Sling/Components

Forestry and
Rigging Hardware

Material Handling
Equipments

CHAIN HOIST

NON-SPARKING CHAIN HOIST CH-EP TYPE

Features:

- Complies with ATEX directive 2014/34/EU and Machinery Directive 2006/42/EC.
- Epoxy powder coated.
- Comes with zinc plated load chain and stainless steel hand chain.
- Copper plated hand chain wheel and hooks.
- Corrosion protected internal components.
- Stainless steel fixings and fasteners.
- Bronze nameplate and rivets.
- Overload protection(optional).

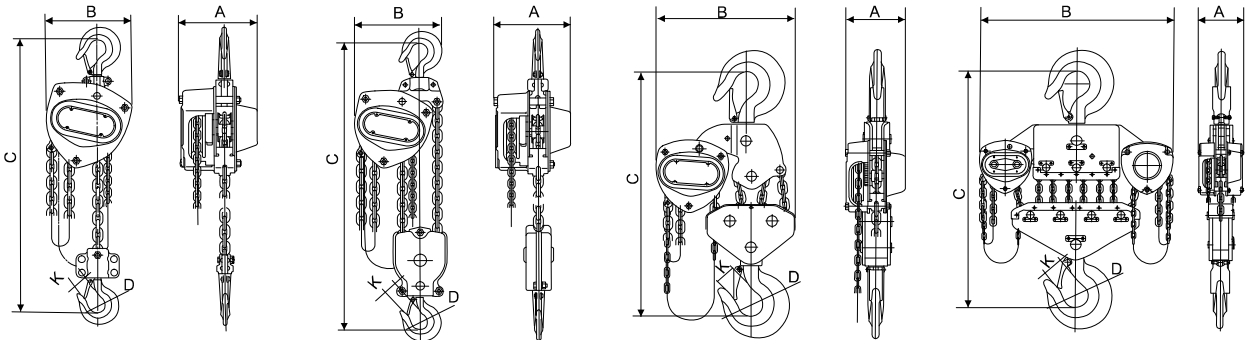

0.5t-3t

5t

10t-15t

20t-30t

Item No.	Capacity	Standard Lift	Proof Load	Effort Required to Lift Rated Load	No. of Falls of Load Chain	Load Chain	Dimensions(mm)					N. W.	Extra Weight per Metre	Product Code
	t	m	kN	N		mm	A	B	C	D	K	kg	kg	
CHEP005	0.5	2.5	7.35	240	1	5X15	132	148	345	35	23	9.3	1.4	
CHEP010	1	2.5	14.7	250	1	6X18	151	172	376	40	26	12.2	1.6	
CHEP015	1.5	2.5	22.05	265	1	7.1X21	173	196	442	45	29.5	16.5	1.9	
CHEP020	2	2.5	29.4	310	1	8X24	175	210	470	50	34	19.5	2.2	
CHEP030	3	3	44.1	372	1	10X30	205	255	530	55	37.5	32	3.1	
CHEP050	5	3	73.5	380	2	10X30	189	280	630	65	41	43	5.3	
CHEP100	10	3	147	385	4	10X30	189	385	780	85	50	80.7	9.6	
CHEP150	15	3	183.75	385	6	10X30	242	405	920	110	80	140	13.9	
CHEP200	20	3	245	390x2	8	10X30	226	640	980	110	80	180	19	
CHEP300	30	3	367.5	390x2	12	10X30	454	705	1280	110	80	350	27.7	

Remarks: Hoists with the lift in other length are also available.

LEVER HOIST

NON-SPARKING LEVER HOIST LH-EP TYPE



Features:

- Complies with ATEX Directive 2014/34/EU and Machinery Directive 2006/42/EC.
- Epoxy powder coated.
- Comes with zinc plated load chain.
- Copper plated hand wheel and hooks.
- Corrosion protected internal components.
- Stainless steel fixings and fasteners.
- Bronze nameplate and rivets.
- Overload protection(optional).

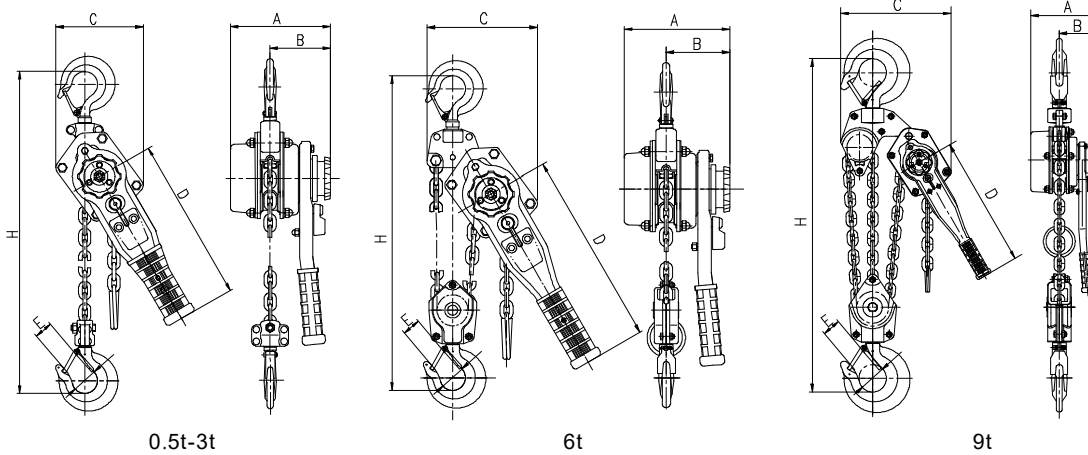

0.5t-3t

6t

9t

Item No.	Capacity	Standard Lift	Proof Load	Effort Required to Lift Rated Load	No. of Falls of Load Chain	Load Chain	Dimensions(mm)						N.W.	Extra Weight per Metre	Product Code
	t	m	kN	N		mm	A	B	C	D	H	E	kg	kg	
LHEP050	0.5	1.5	7.35	256	1	5X15	143	90.5	118	245	330	23.5	5.5	0.6	
LHEP075	0.75	1.5	11	290	1	6X18	152	91.5	132	245	330	26	6.9	0.8	
LHEP100	1	1.5	14.7	300	1	6X18	157	94	140	245	365	26	7.9	0.8	
LHEP150	1.5	1.5	22.1	350	1	7X21	178	104	145	325	400	31	10.9	1.1	
LHEP300	3	1.5	44.1	390	1	10X30	206	118	199	405	520	37	20.2	2.2	
LHEP600	6	1.5	88.2	400	2	10X30	206	118	230	405	590	46	35	4.3	
LHEP900	9	1.5	132.3	410	3	10X30	206	118	342	405	720	55	50	6.5	

Remarks: Hoists with the lift in other length are also available.



LEVER HOIST

Manual Hoisting
Equipments

Electric Hoisting
Equipments

Textile Sling and
Height Safety

Transport and
Load Restraints

Lifting Chain/Chain
Sling/Components

Wire Rope/Wire Rope
Sling/Components

Forestry and
Rigging Hardware

Material Handling
Equipments

LEVER HOIST LH-A TYPE

Features:

- Light weight robust construction.
- Automatic double pawl braking system.
- Low effort to lift maximum load.
- Extra thick asbestos free friction discs.
- Free-wheeling mechanism for quick chain adjustment.
- Drop forged alloy hooks are designed to stretch when overloaded before chain failure and are equipped with integrated heavy duty safety latch.
- Comes with high grade alloy steel load chain.
- Each hoist is proof tested at 1.5 times the rated capacity.
- Complies with EN13157, ASME B30.21, AS1418.2 and SANS 1636.
- Bottom hook with bearing(optional).
- Overload protection(optional).
- Shipyard hook(optional).
- Needle roller bearing between load sprocket and side plates(optional).



LEVER HOIST

LEVER HOIST LH-A TYPE

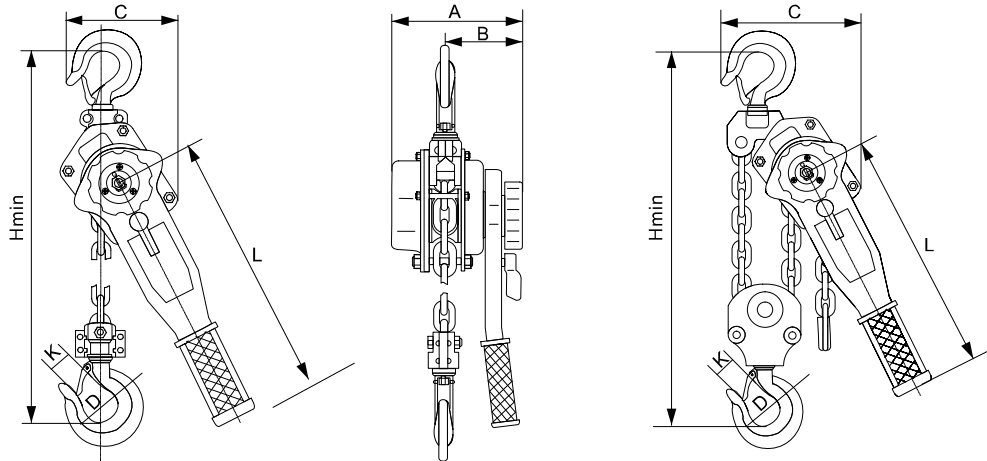

0.75t, 1.5t, 3t

6t, 9t

Item No.	Capacity	Standard Lift	Proof Load	Effort Required to Lift Rated Load	No. of Falls of Load Chain	Load Chain	Dimensions(mm)						N.W.	Extra Weight per Metre	Product Code	
	t	m	kN	N		mm	A	B	C	D	Hmin	L	K	kg		kg
LHA0.75T	0.75	1.5	11.0	140	1	6x18	148	88	135	37	320	290	26	6.3	0.8	
LHA1.5T	1.5	1.5	22.1	240	1	8x24	176	102	162	45	380	420	32.5	11	1.4	
LHA3.0T	3	1.5	44.1	320	1	10x30	195	109	211	50	480	420	37	18.7	2.2	
LHA6.0T	6	1.5	88.2	340	2	10x30	195	109	254	64	620	420	46	30	4.3	
LHA9.0T	9	1.5	132.3	360	3	10x30	195	109	319	85	700	420	50	41.2	6.5	

Remarks: Hoists with the lift in other length are also available.



Manual Hoisting Equipments

Electric Hoisting Equipments

Textile Sling and Height Safety

Transport and Load Restraints

Lifting Chain/Chain Sling/Components

Wire Rope/Wire Rope Sling/Components

Forestry and Rigging Hardware

Material Handling Equipments

LEVER HOIST

 Manual Hoisting
Equipments

 Electric Hoisting
Equipments

 Textile Sling and
Height Safety

 Transport and
Load Restraints

 Lifting Chain/Chain
Sling/Components

 Wire Rope/Wire Rope
Sling/Components

 Forestry and
Rigging Hardware

 Material Handling
Equipments

LEVER HOIST LH-V TYPE

Features:

- Compact and extra strong lever enables narrow space operation.
- Modified cast hand wheel for added strength and durability.
- Ergonomically designed load chain end stop.
- Drop forged alloy hooks are designed to stretch when overloaded before chain failure and are equipped with integrated heavy duty safety latch.
- Comes with high grade alloy steel load chain.
- Each hoist is proof tested at 1.5 times the rated capacity.
- Complies with EN13157, ASME B30.21, AS1418.2, SANS 1636.
- Bottom hook with thrust bearing(optional).
- Overload protection(optional).

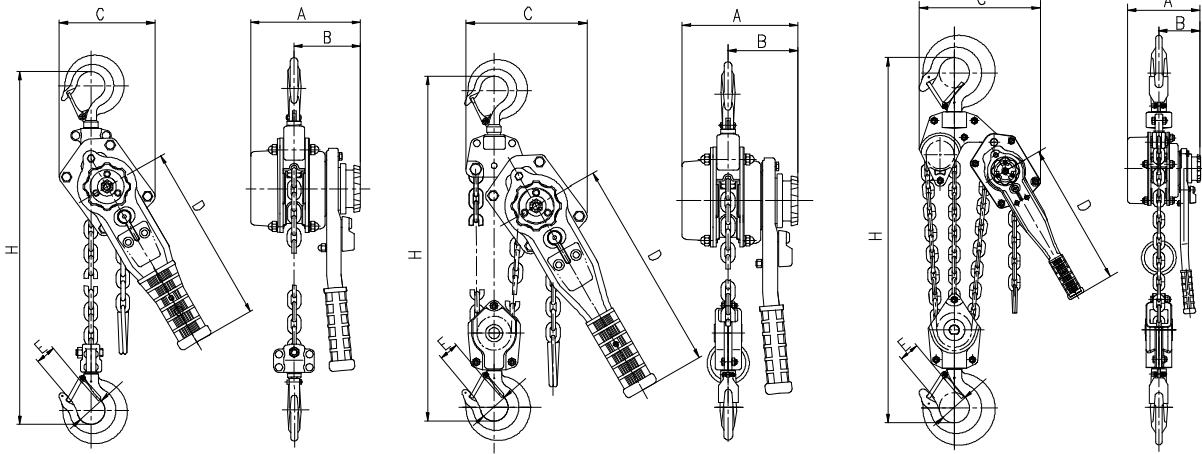

0.5t-3t

5t-6.3t

9t

Item No.	Capacity	Standard Lift	Proof Load	Effort Required to Lift Rated Load	No. of Falls of Load Chain	Load Chain	Dimensions(mm)						N.W.	Extra Weight per Metre	Product Code
	t	m	kN	N		mm	A	B	C	D	H	E	kg	kg	
LHV050	0.5	1.5	7.35	256	1	5 x 15	143	90.5	118	245	330	22	5.5	0.6	
LHV075	0.75	1.5	11	290	1	6 x 18	152	91.5	132	245	330	24	6.9	0.8	
LHV080	0.8	1.5	11.8	290	1	6 x 18	152	91.5	132	245	330	24	6.9	0.8	
LHV100	1	1.5	14.7	300	1	6 x 18	157	94	140	245	365	27	7.5	0.8	
LHV150	1.5	1.5	22.1	350	1	7 x 21	178	104	145	325	400	29	11.8	1.1	
LHV160	1.6	1.5	23.5	350	1	7 x 21	178	104	145	325	400	29	11.8	1.1	
LHV300	3	1.5	44.1	390	1	10 x 30	206	118	199	405	520	40	20.5	2.2	
LHV320	3.2	1.5	47	390	1	10 x 30	206	118	199	405	520	40	20.5	2.2	
LHV500	5	1.5	88.2	400	2	10 x 30	206	118	230	405	590	46	32	4.3	
LHV630	6.3	1.5	92.6	400	2	10 x 30	206	118	230	405	590	46	32	4.3	
LHV900	9	1.5	132.3	410	3	10 x 30	206	118	342	405	720	49	54	6.5	

Remarks: Hoists with the lift in other length are also available.

LEVER HOIST

MINI LEVER HOIST LH-S TYPE, ALUMINIUM BODY

Features:

- Extremely light weight aluminium housing.
- Automatic double pawl braking system.
- Four links load sprocket, for stability during lifting and less stress on the load chain.
- Drop forged alloy hooks are designed to stretch when overloaded before chain failure and are equipped with integrated heavy duty safety latch.
- The top and bottom hooks are marked to indicate overload.
- Come with zinc-plated load chain.
- Each hoist is proof tested at 1.5 times the rated capacity.
- Complies with EN13157, ASME B30.21, AS1418.2 and SANS1636.
- Carry bag(optional).

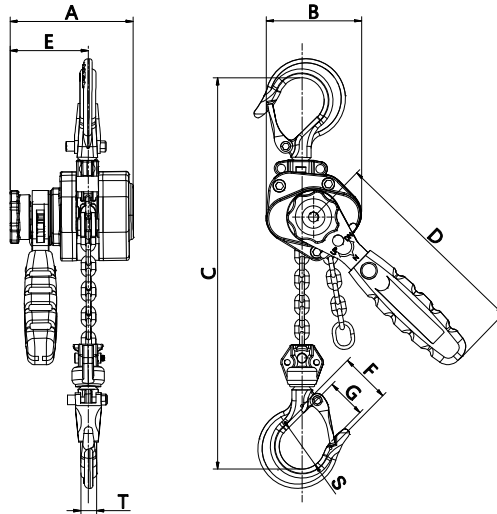
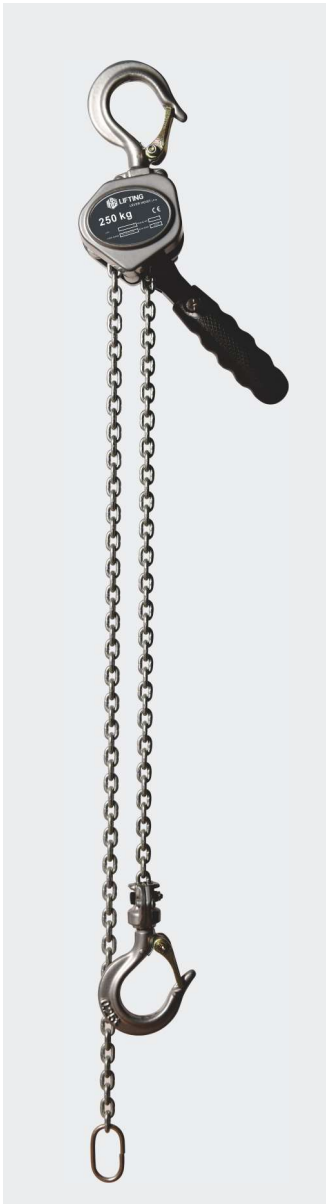

Item No.	Capacity	Standard Lift	Proof Load	Effort Required to Lift Rated Load	No. of Falls of Load Chain	Load Chain	Dimensions(mm)										N.W.	Product Code
	kg	m	kN	N		mm	A	B	C	D	E	F	G	S	T	kg		
LHS0.25T	250	1.5	3.68	200	1	3.2x9	90	68	200	150	56	35.5	20	32	11	1.55		
LHS0.5T	500	1.5	7.35	240	1	4.3x12	98	81	250	172	62	42	21	34.5	12.5	2.55		

Remarks: Hoists with the lift in other length are also available.

PUSH AND GEARED TROLLEY

- Push trolleys are generally suited to lesser loads and lower suspension levels.
- Geared trolleys are generally suited to heavier loads, higher suspension levels or high use applications. Geared trolley is ideal for use when precise positioning of the trolley is required.

PUSH TROLLEY PT-CA TYPE



Item No.	Capacity		Proof Load kN	Min. Radius of Curve m	Dimensions(mm)							Adjustable Beam Width M (mm)		N.W. (kg)		Product Code
	t	kN			A		B	C	E	F	H	standard beam	extra long beam	standard beam	extra long beam	
PTCA0.5T	0.5	7.35	0.9	264	315	216	195	31		110	64-152	82-203	8.6	9.2		
PTCA1T	1	14.7	1	335	437	260	239	32.5		136	64-203	102-305	15.4	16.6		
PTCA2T	2	29.4	1.1	353	455	300	286	31	3	161	88-203	102-305	23	25.1		
PTCA3T	3	44.1	1.3	371	473	345	336	35		185	102-203	102-305	40	43.8		
PTCA5T	5	73.5	1.4	393	490	390	393	37		220	114-203	108-305	50	53.8		
PTCA10T	10	147	1.7	436	532	470	500	45		280	125-203	117-305	97	102.5		

Features:

- Customizable to any beam width by adjusting the amount of spacers.
- The anti-drop plates design ensures extra safety, and also prevents damage to wheels when contacting end rail stoppers.
- Permanently lubricated, ball bearing mounted wheels allow for smooth traversing.
- Complies with the Machinery Directive 2006/42/EC.
- PT-CA push trolley can be supplied to suit various track widths within the standard beam range and the extended beam range.

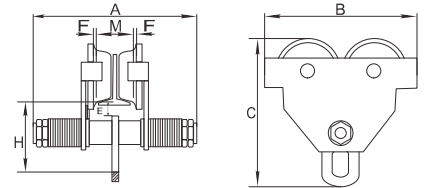

GEARED TROLLEY GT-CA TYPE

Item No.	Capacity		Proof Load kN	Effort Required to Lift Rated Load N	Min. Radius of Curve m	Dimensions(mm)							Adjustable Beam Width M (mm)		N.W. (kg)		Product Code
	t	kN				A		B	C	E	F	H	standard beam	extra long beam	standard beam	extra long beam	
GTCA1T	1	14.7	44	1	390	492	260	239	32.5		136	64-203	102-305	19.9	21.1		
GTCA2T	2	29.4	80	1.1	400	502	300	286	31		161	88-203	102-305	28.5	30.6		
GTCA3T	3	44.1	65	1.3	430	532	345	336	35	3	185	102-203	102-305	46	49.8		
GTCA5T	5	73.5	90	1.4	444	544	390	393	37		220	114-203	108-305	57	60.8		
GTCA10T	10	147	195	1.7	489	584	470	500	45		280	125-203	117-305	103	108.5		

Features:

- Customizable to any beam width by adjusting the amount of spacers.
- The anti-drop plates design ensures extra safety, and also prevents damage to wheels when contacting end rail stoppers.
- Permanently lubricated, ball bearing mounted wheels allow for smooth traversing.
- Standard with hand chain for 3 meter operating height. Other length of hand chain is available on request.
- Complies with the Machinery Directive 2006/42/EC.
- GT-CA geared trolley can be supplied to suit various track widths within the standard beam range and the extended beam range.

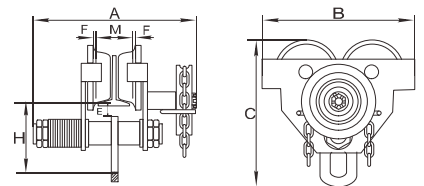

BEAM CLAMP

BEAM CLAMP BC TYPE



Item No.	Capacity t	Proof Load kN	Beam Width mm	Dimensions(mm)										N.W. kg	Product Code	
				A		B		C	D	E	F		G			H
				max.	min.	max.	min.				max.					
BC1T	1	19.6	75-230	240	192	367	94	4	194	102	154	22	20	4		
BC2T	2	39.2	75-230	240	192	367	102	6	194	102	154	22	20	4.8		
BC3T	3	58.8	80-345	355	243	520	132	8	241	133	223	38	22	9.8		
BC5T	5	98	80-345	355	243	520	142	10	241	133	223	35	28	11.6		
BC10T	10	196	90-350	360	272	532	180	12	284	155	234	47	38	17		

Features:

- Firm anchor point for lifting and pulling.
- Spindle enables quick mounting.
- Designed to accommodate a wide range of beam width.
- Provide super quick adjustment to most I-beams and H-beams.
- Complies with the Machinery Directive 2006/42/EC.

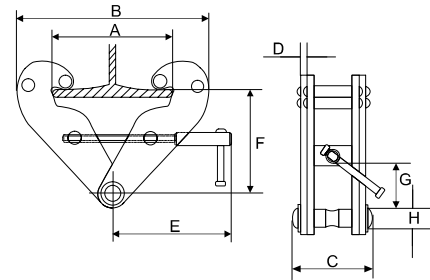

BEAM CLAMP WITH RING BCR TYPE



Item No.	Capacity t	Proof Load kN	Beam Width mm	Dimensions(mm)										N.W. kg	Product Code		
				A		B		C	D	E	F		G			H	K
				max.	min.	max.	min.				max.						
BCR010	1	19.6	75-230	240	192	367	94	4	194	102	154	20	30	45	4.2		
BCR020	2	39.2	75-230	240	192	367	102	6	194	102	154	20	30	45	5.1		
BCR030	3	58.8	80-345	355	243	520	132	8	241	133	223	32	45	63	10.4		
BCR050	5	98	80-345	355	243	520	142	10	241	133	223	32	45	63	12.2		
BCR100	10	196	90-350	360	272	532	180	12	284	157	234	43	64	95	18.8		

Features:

- Bottom ring for ease of attaching a chain or lever hoist.
- Firm anchor point for lifting and pulling.
- Spindle enables quick mounting.
- Designed to accommodate a wide range of beam width.
- Provide super quick adjustment to most I-beams and H-beams.
- Complies with the Machinery Directive 2006/42/EC.
- Folded handle(optional).

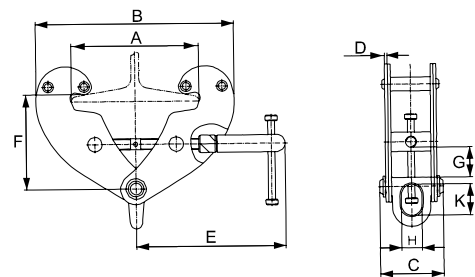
 Manual Hoisting
Equipments

 Electric Hoisting
Equipments

 Textile Sling and
Height Safety

 Transport and
Load Restraints

 Lifting Chain/Chain
Sling/Components

 Wire Rope/Wire Rope
Sling/Components

 Forestry and
Rigging Hardware

 Material Handling
Equipments

LIFTING CLAMP

VERTICAL LIFTING CLAMP VLC-A TYPE



Item No.	Capacity	Proof Load	Jaw Opening	Dimensions(mm)				N.W.	Product Code
	t	kN	mm	T	U	V	L	kg	
VLCA0.8T	0.8	15.68	0-16	122	250	40	52	2.6	
VLCA1T	1	19.6	0-22	124	276	46	54	3.6	
VLCA2T	2	39.2	0-30	154	320	57	59	5.8	
VLCA3T	3	58.8	0-40	185	383	69	68	9.4	
VLCA5T	5	98	0-50	224	446	65	81	16.2	
VLCA8T	8	156.8	0-60	253	500	70	95	24.9	
VLCA10T	10	196	0-90	309	583	82	95	33.4	
VLCA12T	12	235.2	25-110	370	604	82	104	43.9	
VLCA16T	16	313.6	50-150	412	711	90	122	62.8	
VLCA20T	20	392	50-150	412	711	90	126	67.3	
VLCA30T	30	588	0-115	491	845	100	151	125	

Features:

- For vertical lifting, transporting and turning of all steel plates and structures.
- Min. WLL is 10% of max. WLL.
- Always equipped with a safety mechanism, ensuring the clamp does not slip when lifting force is applied and when load is being lowered.
- Lightweight design for easy handling.
- Tough quality heavy duty welded shell body.
- Maintenance-friendly, easy to replace parts which are available upon request.
- These clamps are only suitable for lifting single plate with a surface hardness below 30 Rockwell C (HRC).

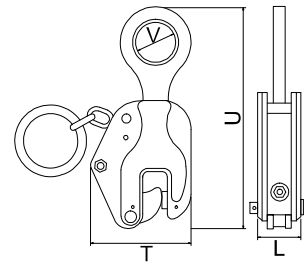

UNIVERSAL VERTICAL LIFTING CLAMP ULC-A TYPE



Item No.	Capacity	Proof Load	Jaw Opening	Dimensions(mm)				N.W.	Product Code
	t	kN	mm	T	U	V	L	kg	
ULCA0.8T	0.8	15.68	0-15	220	30	107	51	1.9	
ULCA1T	1	19.6	0-20	293	48	143	62	4.6	
ULCA2T	2	39.2	0-25	366	65	172	72	7.4	
ULCA3.2T	3.2	58.8	0-30	430	74	218	90	14.8	
ULCA5T	5	98	0-50	479	78	238	102	20.7	
ULCA8T	8	156.8	0-45	556	78	296	115	34	
ULCA12T	12	235.2	50-90	691	90	425	130	58	
ULCA16T	16	313.6	50-150	700	90	425	132	75	
ULCA20T	20	392	50-150	700	90	425	140	80	

Features:

- For vertical lifting, transporting and turning of all steel plates and structures from all positions.
- Min. WLL is 10% of max. WLL.
- With articulated lifting shackle for universal lifting flexibility at various angles.
- The articulated lifting shackle guarantees a pressure grip in every position, even when side loading up to 90 degrees. When lifting in an angle higher than 45 degrees, please check the WLL reduction below.
- Longer plates can be lifted without the use of a spreader beam when using two clamps on a two legged chain sling.
- Always equipped with a safety mechanism, ensuring the clamp does not slip when vertical lifting force is applied and when load is being lowered.
- Clamp is locked in closed as well as open position.
- Lightweight, maintenance-friendly, heavy duty body.
- These clamps are only suitable for lifting single plates with a surface hardness below 30 Rockwell C (HRC).

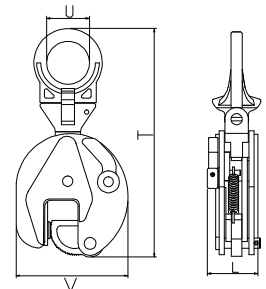

LIFTING CLAMP

HORIZONTAL LIFTING CLAMP HLC-B TYPE

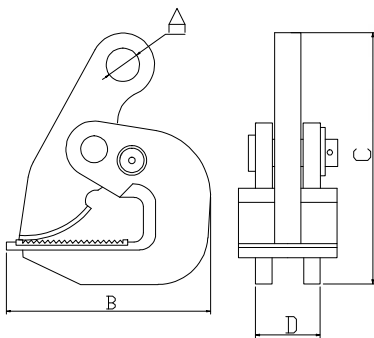

Item No.	Capacity Per Pair	Jaw Opening	Dimensions(mm)				N.W.	Product Code
			t	mm	A	B		
HLCB0.8T	0.8	0-25	25	131	176	35	2.3	
HLCB1.0T	1	0-30	25	155	215	35	3.5	
HLCB1.6T	1.6	0-30	25	155	215	40	3.7	
HLCB2.0T	2	0-40	25	175	245	44	5	
HLCB3.2T	3.2	0-45	28	190	250	48	5.9	
HLCB4.0T	4	0-50	30	190	270	48	6.2	
HLCB5.0T	5	0-55	30	190	270	54	7.2	
HLCB6.0T	6	0-65	30	215	300	56	10	
HLCB6.0T-B	6	0-130	42	310	480	56	21.2	
HLCB8.0T	8	0-100	45	340	505	57	23.9	
HLCB10.0T	10	0-125	60	410	654	60	27.7	

Features:

- HLC-B type clamp is a horizontal lifting clamp intended to be used in pairs, sets of pairs, or in a tripod arrangement for transporting steel plates horizontally.
- Lightweight design for easy handling.
- Clamping force increases in proportion to load weight.
- These clamps are only suitable for lifting single plate with a surface hardness below 30 Rockwell C (HRC).

Note:

- The capacities shown in the table are based on a set of two clamps.
- The top angle between the chain/rope legs must not exceed 30° from vertical.

HORIZONTAL LIFTING CLAMP HLC-FS AND HLC-F TYPE

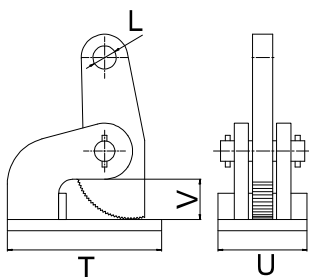

Item No.	Capacity Per Pair	Jaw Opening	Dimensions(mm)				N.W.	Product Code
			t	mm	T	U		
HLCFS0.5T	0.5	0-35	130	65	50	20	2.5	
HLCFS1.0T	1	0-60	175	75	80	25	5.1	
HLCFS1.5T	1.5	0-60	182	75	80	30	6.5	
HLCFS2.0T	2	0-60	185	80	80	30	7.5	
HLCFS3.0T	3	0-60	220	90	80	30	10.4	
HLCFS4.0T	4	0-60	220	95	80	30	12.2	
HLCFS5.0T	5	0-60	220	95	75	30	14.2	
HLCFS10.0T	10	0-60	225	120	73	32	22.2	
HLCF1.0T	1	0-100	175	75	120	25	5.9	
HLCF1.5T	1.5	0-100	182	75	120	30	7.5	
HLCF2.0T	2	0-100	185	80	120	30	8.6	
HLCF3.0T	3	0-100	220	90	120	30	12	
HLCF4.0T	4	0-100	220	95	120	30	14.5	
HLCF5.0T	5	0-100	220	99	115	30	16.5	
HLCF10.0T	10	0-100	225	120	113	32	25.4	

Features:

- HLC-F and HLC-FS type clamps are horizontal lifting clamps intended to be used in pairs, sets of pairs, or in a tripod arrangement for transporting steel plates horizontally.
- The HLC-F clamps are supplied with enlarged jaw opening.
- Lightweight design for easy handling.
- Clamping force increases in proportion to load weight.
- These clamps are only suitable for lifting single plate with a surface hardness below 30 Rockwell C (HRC).

Note:

- The capacities shown in the table are based on a set of two clamps.
- The top angle between the chain/rope legs must not exceed 30° from vertical.

LIFTING CLAMP

UNIVERSAL SCREW CAM CLAMP SCC TYPE



Item No.	Capacity	Jaw Opening	Dimensions(mm)					N.W.	Product Code
	t	mm	A	B	C	D	E	kg	
SCC0.5T	0.5	0-28	52	158	11	18	105	0.7	
SCC0.75T	0.75	0-22	62	185	13	30	135	2.7	
SCC1.5T	1.5	0-32	77	215	16	30	155	4	
SCC3T	3	0-50	88	270	19	36	191	6	
SCC6T	6	0-75	153	290	32	45	255	18	

Features:

- For vertical and horizontal lifting and transportation of a large variety of steel structures.
- Can also be attached upside down and be used as a (temporary) lifting point.
- No min. WLL.
- Special universal design ensures multi-purpose applications of lifting steel structures.
- Fitted with a moveable cam on the thread spindle which provides a powerful clamping force on the workpiece.
- Equipped with a safety screw spindle mechanism, ensuring the clamp does not slip when lifting force is applied.
- Lightweight design for easy handling.
- Tough quality drop forged body.
- Maintenance-friendly, easy to replace parts which are available upon request.
- The hardness of the cam and pivot is suitable to lift material with a maximum hardness of 30 HRC.

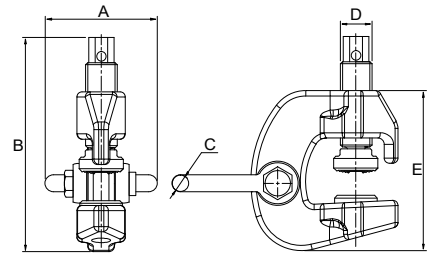

PIPE LIFTING CLAMP PLC TYPE



Item No.	Capacity Per Pair	Jaw Opening	Dimensions(mm)				N.W.	Product Code
	t	mm	A	B	D	E	kg	
PLC015	1.5	40	122	40	25	39	2.2	
PLC030	3	40	122	40	25	39	2.6	
PLC040	4	50	122	50	28	39	2.9	
PLC060	6	50	122	50	30	39	3.4	
PLC080	8	70	126	70	30	39	3.7	
PLC120	12	70	160	70	36	45	7.2	
PLC160	16	70	168	70	40	50	9.4	
PLC180	18	70	183	70	40	56	13	

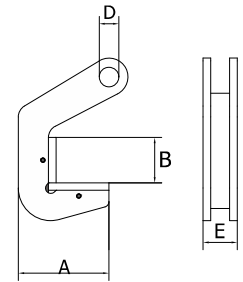

Features:

- For horizontal lifting and transporting of steel and concrete pipes without damaging the product.
- PLC type lifting clamps must always be used in pairs.
- Jaw is covered with a special high quality pressure resistant plastic.
- Maintenance-friendly clamps, plastic pressure resistant cover is easy to be changed.
- Compact design and high lifting capacity.
- Lightweight design for easy handling.
- Tough quality heavy duty body.
- If the thickness of material to be lifted is less than "B" - the top angle must be between 10-60 degrees maximum for a safe lift.
- If the thickness of material to be lifted is equal to "B" - the top angle must be between 10-90 degrees maximum for a safe lift.

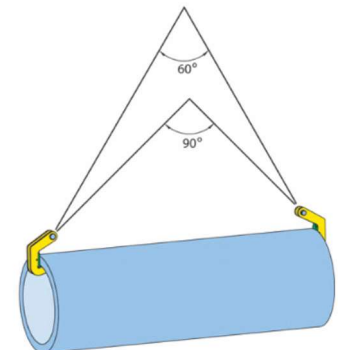

LIFTING CLAMP

ROUND STEEL LIFTING CLAMP RLC TYPE



Item No.	Capacity	Proof Load	Jaw Opening (A)	B	C	N.W.	Product Code
	t	kN	mm			kg	
RLC0.5T	0.5	9.8	50-100	50	12	3.2	
RLC1.0T	1	19.6	50-100	50	14	4.1	
RLC2.0T	2	39.2	80-130	60	18	16	
RLC3.0T	3	58.8	120-220	68	18	32	
RLC5.0T	5	98	200-320	80	25	104	

Features:

- For horizontal lifting and transporting of tubes, pipes, tube bundles, rolls and other solid round materials.
- The clamp is locked in the open position. To perform lifting, the operator must activate the handle and hold it up while the force on the lifting eye is going upwards. When laying down the load, the clamp automatically locks itself open.
- Lightweight design and easy to use.
- Tough quality body.

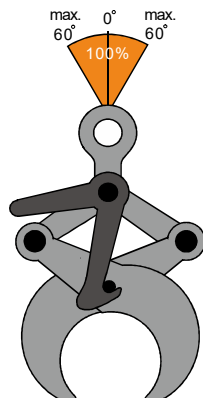
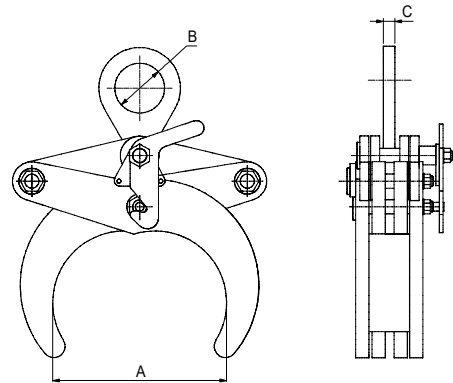

LIFTING CLAMP

DRUM LIFTING CLAMP DLC-C TYPE

Item No.	Capacity	Proof Load	Jaw Opening	Dimensions(mm)				N.W.	Product Code
	t	kN	mm	A	B	C	D	kg	
DLCC0.5T	0.5	9.8	0-17	125	95	40	30	1.5	

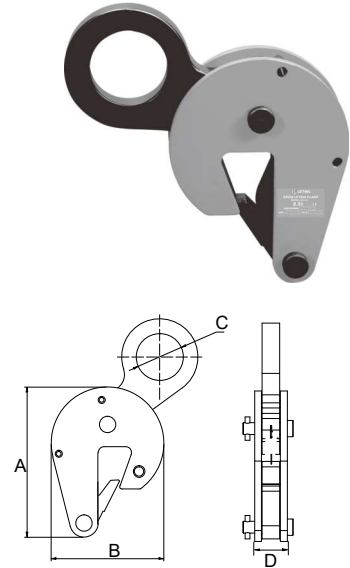
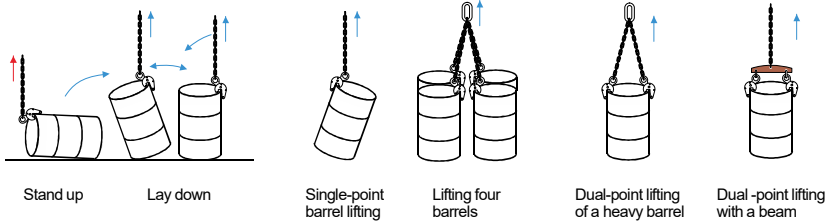

Features:

- Designed for safe lifting, handling and transporting of steel (oil) drums.
- Single clamp application can be used for empty or filled sealed drums. Filled open drums should be lifted by use of two clamps with a two-leg chain sling.
- Includes automatic locking mechanism.
- Lightweight design for easy handling.
- Heavy duty welded shell body.
- Maintenance-friendly, easy to exchange parts which are available upon request.



DRUM LIFTER DL TYPE

Item No.	Capacity	Proof Load	Jaw Opening	Dimensions(mm)				N.W.	Product Code
	t	kN	mm	A	B	C	D	kg	
DL1.0T	1	19.6	0-25	500	63	87	6	3.6	

Features:

- For safe lifting and transporting of steel (oil) drums.
- With automatic locking mechanism.
 - The drum clamps can be used single or per pair as well.
 - Clamps firmly on 2- leg G80 chain sling.
 - This clamp is extremely light weight and very quick and easy to use.

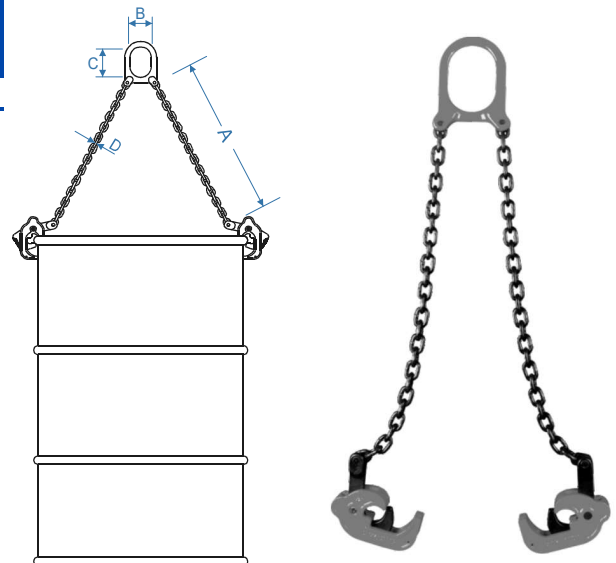

LIFTING CLAMP

CONCRETE PIPE LIFTING CLAMP CPL TYPE

Item No.	Capacity	Jaw Opening	Dimensions(mm)					N.W.	Product Code
	t	mm	A	B	C	D	E	kg	
CPL0.5T	0.5	40-120	416	347	20	53	64	12.4	
CPL1T	1	50-180	413	461	25	61	75	23.7	
CPL1T-B	1	90-220	420	488	25	61	75	25.0	

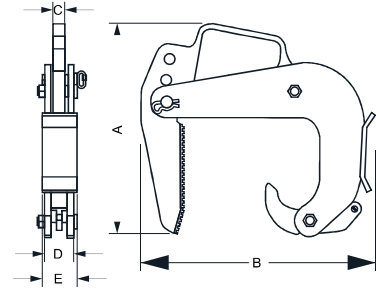

Features:

- The concrete pipe lifting clamps are used in sets of three for the vertical transportation of concrete pipe sections with a diameter of up to 2m.
- The jaw capacity is designed for pipe thickness of 40- 120mm for the 1.5t capacity set and 90-220mm for the 3.0t capacity set.
- Attachment and removal of the clamps from the pipe is extremely easy due to the simple and straightforward design.
- For concrete according to DIN4034.
- The capacities shown are based on a set of three clamps.
- Solid construction and lightweight design.
- Safety Factor: 4:1.



CONCRETE PIPE LIFTING CLAMP SET CPLC TYPE

Item No.	Capacity	Jaw Opening (Z)	Mouth Depth (E)	Pressure Line (F)	Chain/G-80	Dimensions(mm)				N.W.	Product Code
	3pcs per set	mm	mm	mm	mm	A	B	C	D	kg	
CPLC150	1.5	40-120	165	100	6x18	135	75	18	180	42.5	
CPLC318	3	50-180	245	175	10x30	180	100	26	310	92	
CPLC320	3	90-220	245	175	10x30	180	100	26	310	96.5	

Features:

- The concrete pipe lifting clamps are used in sets of three for the vertical transportation of concrete pipe sections with a diameter of up to 2m.
- Please position evenly the pipe lifting clamps on the edge of the manhole to be lifted, at 120 degree from one another(use in set of 3).
- Please ensure that the automatic closing of the lifting clamps and load proportional clamping minimises the damage risk.
- Use with a set of 3 pipe lifting clamps is recommended for handling circular manholes.
- Do not turn over manholes with these pipe lifting clamps.
- Lifting clamps are not suitable for creating permanent joints.
- The capacities shown are based on a set of three clamps.
- The standard length of a sling's leg is 1.5m, 2.1m is also available upon request.

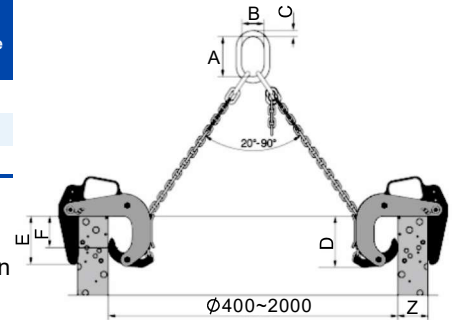

MAGNETIC LIFTER

The permanent magnetic lifter can be used in a variety of industries for the transportation and lifting of steel, engine parts, semi manufactured goods and moulds. No electricity is needed to operate the magnetic lifter. Due to its magnetic force there is no need to use slings, clamps, or other holding devices eliminating damage to the surface of lifted goods.

Features:

- This permanent magnetic lifter is especially well suited to handling flat metal sheets, but is also capable of working with cylinders of magnetic material for added convenience and practicality.
- Made with super strong NdFeB magnets.
- It has a higher factor of safety than conventional permanent magnetic lifters.
- It is an easy to operate by turning the magnetic forces on or off via the lever, which incorporates a locking key for extra safety.
- Light weight.
- Painted housing and chrome plated shackle.
- Temperature range: -40°C - +80°C
- Standard: EN 13155
- Safety factor: 3.0:1

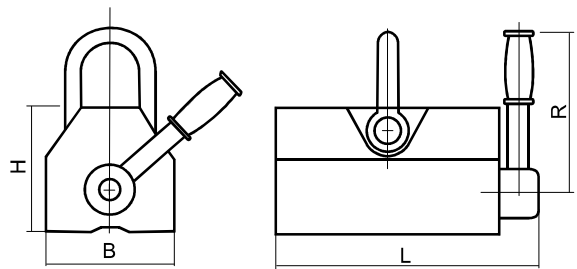

Note: The capacity of the lifting magnet is determined by the thickness and surface quality of the component. Before operation it is necessary to find out the percentage of the steel thickness of the component and capacity curve.

Permanent Magnetic Lifter PML-E Type

Item No.	Rated Lifting Strength	Cylindrical Lifting Strength	Max Pull-off Strength	Dimensions				Operation Temperature	N.W.	Product Code
	kg	kg		L(Length)	B(Width)	H	R			
			kg	mm	mm	mm	mm	°C	kg	
PML-0.1T	100	30	300	126	63	75	165	<80	3	
PML-0.2T	200	60	600	194	94	93	207	<80	9	
PML-0.3T	300	100	900	194	94	93	207	<80	9	
PML-0.6T	600	200	1800	250	110	117	240	<80	18	
PML-1T	1000	300	3000	303	135	140	270	<80	33	
PML-1.5T	1500	500	4500	393	154	168	368	<80	61	
PML-2T	2000	600	6000	428	160	172	390	<80	71	
PML-3T	3000	—	9000	499	184	184	450	<80	105	
PML-5T	5000	—	15000	731	256	258	712	<80	235	

CRANE SCALE

CRANE SCALE HACS-H TYPE

Crane Scales HACS type are built to safely help weigh suspended loads in industrial environments. They connect directly to a load hook and attach to the load being weighed through permanent magnetic lifter, chain assembly, etc. Models with wireless remote controls allow you to change units and clear measurements from a safe distance.

Features:

- 38mm LED display.
- Manual or remote operation.
- Easy to replace lead-acid battery and AC to DC power adaptor.
- 6V/10Ah rechargeable battery included.
- Infrared remote control.

Specifications

Tare Range	100% of full scale
Zero Range	+4% of full scale
Max. Safe Load	120% of full scale
Ultimate Load	400% of full scale
Battery Type	Full sealed lead-acid battery, 6V/10Ah
Power Supply	AC 100~ 220V 50/60Hz
Charger	DC 9V/1500mA
Operating Temperature	-10 °C~ +40 °C
Remote Control Batteries	2 x AA (Included)

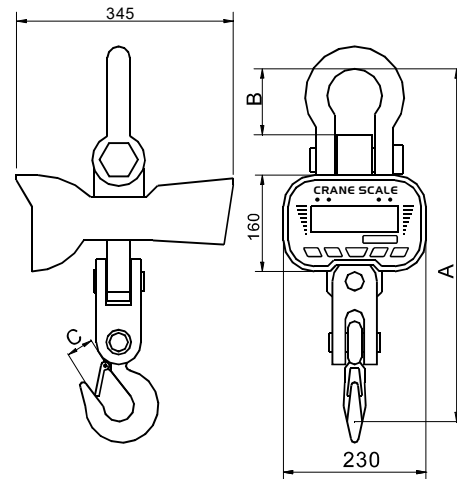

Item No.	Max. Capacity	Min. Capacity	Division Value	Dimensions(mm)			Weight	Packing Size (cm)	Product Code
	ton	kg	kg	A	B	C	kg		
HACS-1T	1	10	0.5	470	95	27	11	49x45x29	
HACS-2T	2	20	0.5	475	95	32	11.2	49x45x29	
HACS-3T	3	30	1	570	95	37	12	49x45x29	
HACS-5T	5	40	1	610	115	40	16.8	49x45x29	
HACS-10T	10	100	2	725	115	50	30.1	49x45x29	
HACS-15T	15	100	5	820	115	65	33	80x40x40	
HACS-20T	20	200	5	1100	225	85	52	80x40x40	
HACS-30T	30	300	10	1150	160	105	95	80x40x40	

Manual Hoisting
Equipments

Electric Hoisting
Equipments

Textile Sling and
Height Safety

Transport and
Load Restraints

Lifting Chain/Chain
Sling/Components

Wire Rope/Wire Rope
Sling/Components

Forestry and
Rigging Hardware

Material Handling
Equipments

CRANE SCALE

CRANE SCALE HDCS TYPE

The portable crane scale HDCS type features electronic weighing options with the LCD display that is highly visible and offers flexible, adaptive, and accurate measurements. It is widely used in industrial plants, workshops, agricultural markets, etc.

Features:

- Material: aluminium scale body.
- Multi functions: unit conversion, hold, zero, auto power-off, battery check, overload warning.
- Large LCD display: large digits display, clear reading in different environments, even in dark places or from a far distance.
- Selectable units of measurement: kg / lbs / kN.
- Infrared remote control: change units and clear measurements from a safe distance.



Specifications

Tare Range	100% of full scale
Zero Range	+4% of full scale
Max. Safe Load	125% of full scale
Ultimate Load	400% of full scale
Battery Type	3 x Ni-MH batteries, 1.2V
Power Supply	AC 100~ 220V 50/60Hz
Charger	DC 4.5V/500mA
Operating Temperature	-10 °C~ +40 °C
Remote Control Batteries	2 x AA (Included)

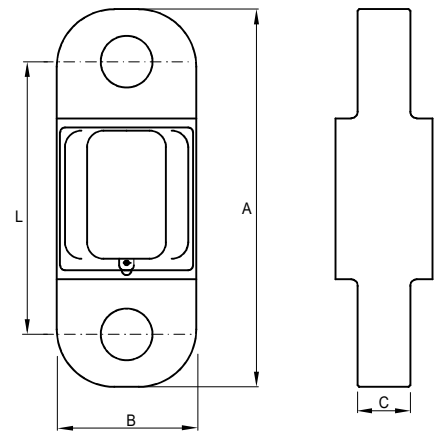

Item No.	Max. Capacity	Min. Capacity	Division Value	Dimensions(mm)				Weight	Product Code
	ton	kg	kg	A	B	C	L	kg	
HDCS-1T	1	10	0.5	230	85	25	165	1.5	
HDCS-2T	2	20	1	230	85	25	165	1.5	
HDCS-2.5T	2.5	20	1	230	85	25	165	1.5	
HDCS-3T	3	30	1	230	85	25	165	1.5	
HDCS-5T	5	40	1	230	85	32	165	1.6	
HDCS-10T	10	100	2	315	100	49	200	3.6	
HDCS-15T	15	150	5	350	126	70	210	7.1	
HDCS-20T	20	200	10	350	126	70	210	7.1	
HDCS-35T	35	200	10	410	120	68	270	21	
HDCS-50T	50	400	20	465	150	100	323	43	
HDCS-100T	100	1000	50	570	190	128	366	82	

CRANE SCALE

CRANE SCALE HDCS-B TYPE WITH SHACKLE AND HOOK

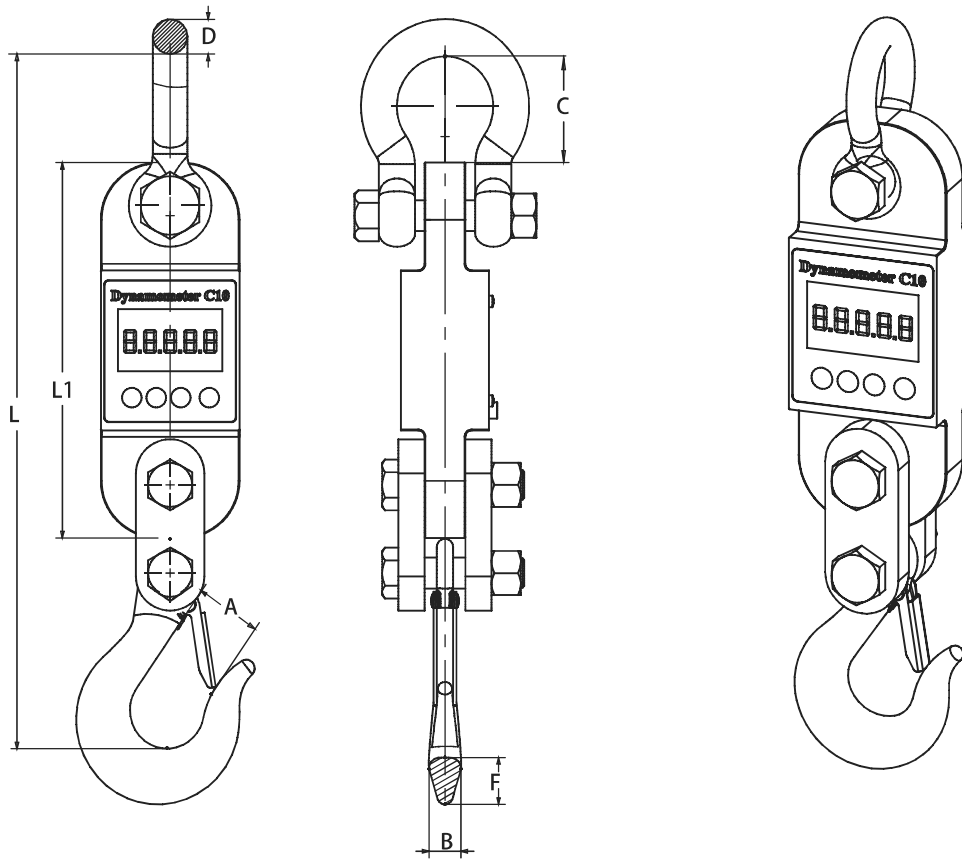

Item No.	Capacity		Division Value	Dimensions(mm)							Product Code
	Max. Capacity	Min. Capacity		A	B	C	D	F	L	L1	
	ton	kg	kg								
HDCSB-1T	1	10	0.5	19	17	38	16	21	370	230	
HDCSB-2T	2	20	1	27	23	38	16	29	410	230	
HDCSB-2.5T	2.5	20	1	27	23	38	16	29	410	230	
HDCSB-3T	3	30	1	27	23	38	16	29	410	230	
HDCSB-5T	5	40	1	32	27	64	22.3	36	460	230	
HDCSB-10T	10	100	2	45	46	80	32.8	58	660	315	
HDCSB-15T	15	150	5	58	56	130	32.8	65	780	350	
HDCSB-20T	20	200	10	73	68	130	46.7	73	850	350	
HDCSB-35T	35	200	10	80	79	160	52.8	92	1000	410	
HDCSB-50T	50	400	20	120	93	230	68.5	117	1250	465	
HDCSB-100T	100	1000	50	170	125	320	95	150	1900	570	

 Manual Hoisting
Equipments

 Electric Hoisting
Equipments

 Textile Sling and
Height Safety

 Transport and
Load Restraints

 Lifting Chain/Chain
Sling/Components

 Wire Rope/Wire Rope
Sling/Components

 Forestry and
Rigging Hardware

 Material Handling
Equipments

WIRE ROPE PULLING HOIST

Wire rope pulling hoist is a compact and lightweight hoist that can be used for lifting, pulling and tightening over a long distance. It works with a steel wire rope running through the jaws of the hoist. The double sets of jaws open in turns so that the wire rope will always stay tight during the operation.

20 m coiled steel wire rope with latch hook is included.

Features:

- Each hoist is dynamic proof load tested 1.5 x WLL before leaving the factory, except 5400KG(1.25 x WLL).
- Compact, lightweight construction.
- Durable construction with powder coated finish and plated frame components.
- Equipped with replaceable shear safety pin that prevents overloading (3 spare pins included).
- 20 m coiled steel wire rope with latch hook is included and other lengths can be offered.
- Hooks fitted with steel safety latches.
- Test certificate and user manual enclosed with each hoist.
- Spare parts available.
- Rotating hook attached to the body is available.
- **Standard:** EN 13157
- **Safety factor:** 4:1



With swivel hook is also available

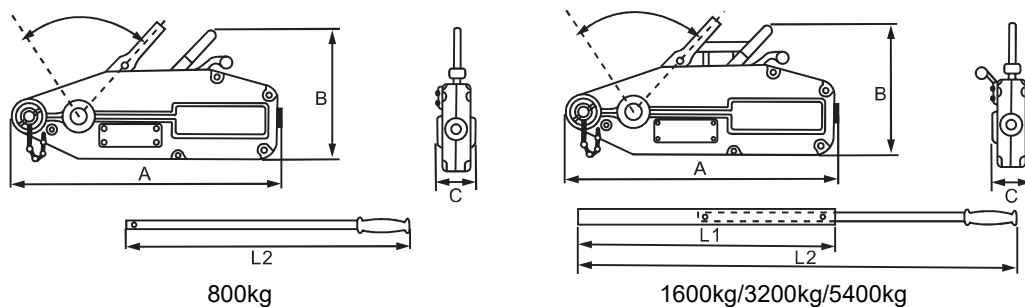

Wire Rope Pulling Hoist WRH-H Type (Aluminum Body)

Item No.	Rated Capacity	Rope Advance per Full Stroke	Lever Pull at WLL	Rope Diameter	Standard Length of Wire Rope	Net Weight without Cable	Cable Weight	Max. Overall Size (mm)			L1 (cm)	L2 (cm)	Product Code
	kg	mm	N	mm	m	kg	kg	A	B	C			
WRHH0.8T	800	>52	343	8.3	20	6.2	6.3	430	240	60	—	80	
WRHH1.6T	1600	>55	441	11	20	11.8	12	556	270	68	70	120	
WRHH3.2T	3200	>28	441	16	20	21.2	22.5	666	320	98	70	120	
WRHH5.4T	5400	>30	745	20	20	56.5	35	940	410	160	70	120	

WIRE ROPE PULLING HOIST

Wire Rope Pulling Hoist WRH-S Type (Steel Body)

Item No.	Rated Lifting Capacity	Rope Advance per Full Stroke	Rated Forward Handpower	Rope Diameter	Standard Length of Wire Rope	Net Weight without Cable	Cable Weight	Max. Overall Size (mm)			L1 (cm)	L2 (cm)	Product Code
	kg	mm	N	mm	m	kg	kg	A	B	C			
WRHS0.8T	800	>52	343	8.3	20	8	6.3	435	250	60	—	80	
WRHS1.6T	1600	>55	441	11	20	14.5	12	540	280	77	70	120	
WRHS3.2T	3200	>28	441	16	20	29	22.5	680	350	91	70	120	

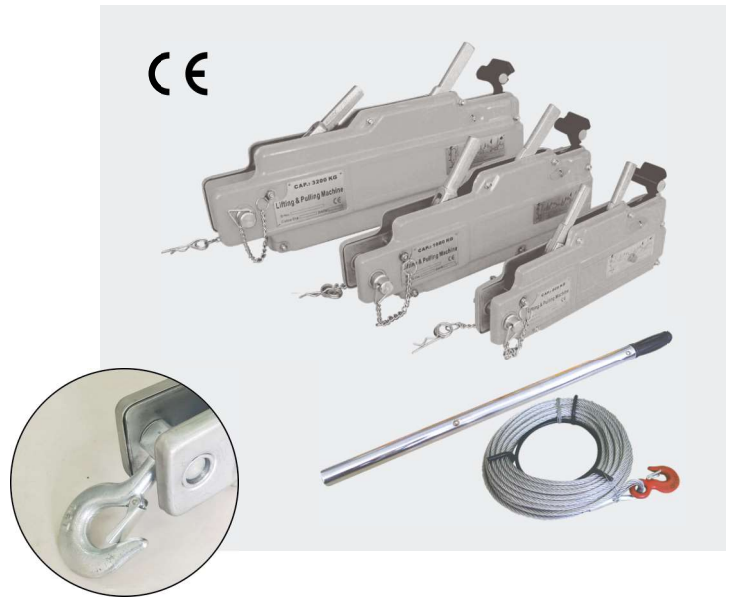
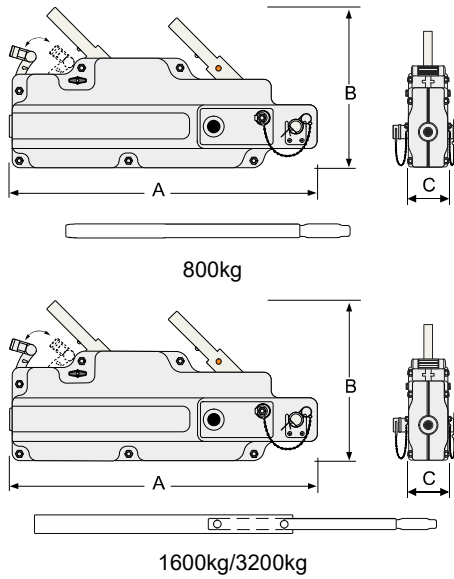

Wire Rope Pulling Hoist WRH-HS Type (Steel Body)

Item No.	Rated Capacity	Rope Advance per Full Stroke	Lever Pull at WLL	Rope Diameter	Standard Length of Wire Rope	Net Weight without Cable	Cable Weight	Max. Overall Size (mm)			L1 (cm)	L2 (cm)	Product Code
	kg	mm	N	mm	m	kg	kg	A	B	C			
WRHH0.8T	800	>52	353	8.3	20	7	6.3	435	245	70	—	80	
WRHH1.6T	1600	>55	412	11	20	12	12	545	286	92	70	120	
WRHH3.2T	3200	>28	441	16	20	23	22.5	655	345	105	70	120	

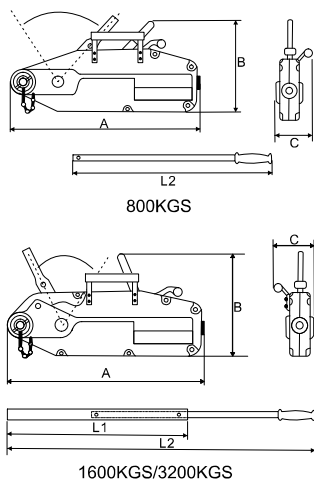
 Manual Hoisting
Equipments

 Electric Hoisting
Equipments

 Textile Sling and
Height Safety

 Transport and
Load Restraints

 Lifting Chain/Chain
Sling/Components

 Wire Rope/Wire Rope
Sling/Components

 Forestry and
Rigging Hardware

 Material Handling
Equipments

HAND WINCH

HAND WINCH HW-C TYPE

Features:

- Fitted with pawls to provide extra safety under all operating conditions.
- Heavy gauge steel construction gives added strength.
- Powder coating finish for resistance to rust and corrosion.
- Positive action brake can hold the load in any position.
- The brake is sealed in a strong steel cover to protect from dust and rain.
- It is compact, light-weight and is of rugged construction.
- Capacity rating is based on one layer of line around drum as line builds on drum capacity decreases.
- With mounting base.
- The winch should only be used for pulling.
- Available with stainless steel SS304 or galvanized finish for corrosion resistance.

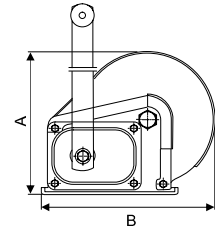

Model	Capacity		Proof Load kN	Gear Ratio	Hand Operated Strength N	Dimensions(mm)						N.W. kg	Product Code	
	kg	lbs				A	B	C	D	F	G			H
HWC0550	550	1200	8	4.2:1	180	156	184	157	208	273	51	110	3.7	
HWC0850	850	1800	12	5:1	190	203	246	190	319	288	60	110	8.1	
HWC1200	1200	2600	17.4	10:1	190	216	294	209	319	307	63	110	10.3	

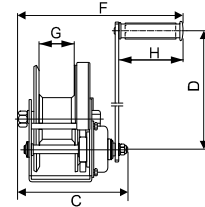

HAND WINCH HW-E TYPE

Features:

- Suitable for pulling applications.
- With automatic load pressure brake and free spooling-mode.
- Large drum capacity.
- With ratchet mechanism.
- Available in galvanized or painted finish.
- Compact design with detachable lever.
- With mounting base.

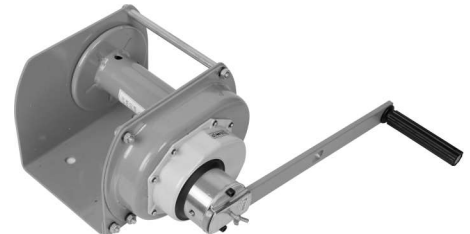
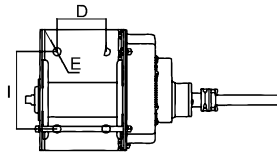
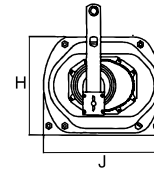
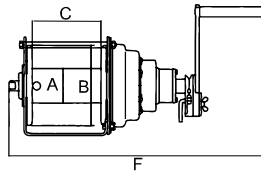

Model	Capacity	Proof Load kN	Wire Rope mm x m	Gear Ratio	Handle Length	Min. Hand Force Required N	Dimensions (mm)								N.W. kg	Product Code	
	t				mm		A	B	C	D	E	F	H	I			J
HWE005	0.5	7.35	6.3x40	4.33:1	350	120	60	140	150	100	15	403	182	130	245	14.4	
HWE010	1	14.7	8x40	12.19:1	350	120	76	175	154	110	18	443	214	170	266	19.7	
HWE020	2	29.4	9x40	22.68:1	350	130	90	190	195	155	18	490	230	170	300	25.1	
HWE030	3	44.1	12.5x40	29.16:1	350	180	100	230	205	155	18	549	296	170	365	44.3	

RATCHET PULLER

RATCHET PULLER

Item No.	Capacity	Rope dia.	Wire rope length	No. of hooks	Product Code
	t	mm	m		
WRP-2H10	1	5	2.3	2	
WRP-2H15	1.5	6	2.3	2	
WRP-3H10	1	5	2.3	3	
WRP-3H15	1.5	6	2.3	3	

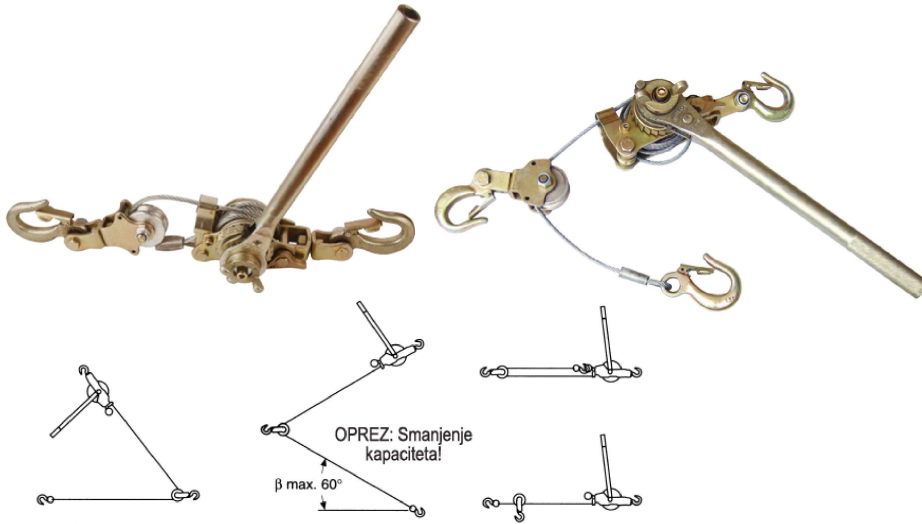

Manual Hoisting
Equipments

Electric Hoisting
Equipments

Textile Sling and
Height Safety

Transport and
Load Restraints

Lifting Chain/Chain
Sling/Components

Wire Rope/Wire Rope
Sling/Components

Forestry and
Rigging Hardware

Material Handling
Equipments

ELECTRIC CHAIN HOIST

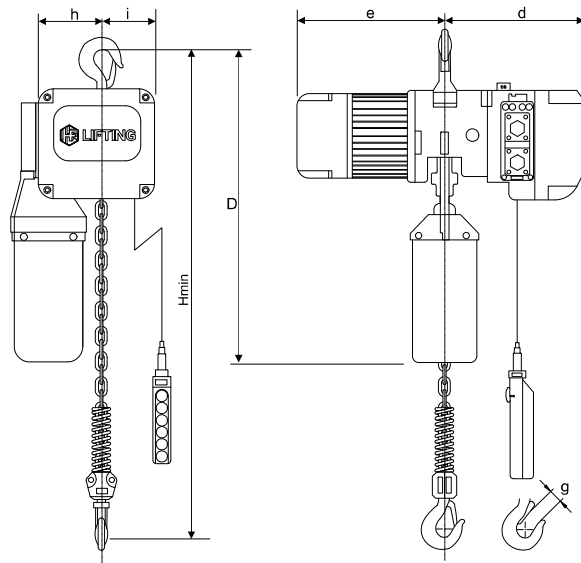

Features:

- Double safety mechanism consisting of overload slipping clutch and upper-lower limit switch.
- Aluminium die cast body and a canvas chain container.
- Uniquely-designed push button control on the basis of ergonomics.
- Electrical and magnetic DC brake.
- Thermal motor protector.
- Control relay is designed to monitor 3-phase power supplies and to protect motor.
- Drop forged alloy hooks are designed to open gradually and not fracture under excessive loads.
- Single or dual lifting speed.
- Operating voltage, 220/380/440V, 50/60Hz, 1/3PH.
- Control voltage 24V.
- Load chain in accordance with standard EN 818-7.
- Radio remote control(optional).
- Frequency inverter(optional).

ELECTRIC CHAIN HOIST EHB TYPE

Model	Capacity		Lifting Speed		Working Group	Hoist Motor		Duty Rating(ED)		Standard Lift	Load Chain	Load Chain Falls	Proof Load	Hmin	Dimensions(mm)						N.W.	Product Code
	t	m/min	m/min	m/min		kw	kw	%	%						m	mm	mm	h	i	e		
EHB0025	0.25	7.0	7.0/2.3	M5/2m	0.9	0.9/0.3	40%	26.6/13.4%	3	5x15	1	3.06	400	142	102	329	334	307	31	610	52	
EHB0050	0.5	7.6	7.6/2.5	M5/2m	0.9	0.9/0.3	40%	26.6/13.4%	3	6.3x19	1	6.13	410	142	102	329	334	307	31	610	54	
EHB0100	1	5.0	5.0/1.7	M5/2m	1.1	1.1/0.37	40%	26.6/13.4%	3	8x24	1	12.25	460	142	102	329	354	307	38	630	62	
EHB0200	2	2.5	2.5/0.85	M5/2m	1.1	1.1/0.37	40%	26.6/13.4%	3	8x24	2	24.5	650	185	159	329	354	307	45	720	73	
EHB0300	3	6.0	6.0/2.0	M5/2m	3	3/1	40%	26.6/13.4%	3	11.2x34	1	36.75	525	185	165	358	471	336	45	780	124	
EHB0500	5	3.0	3.0/1.0	M5/2m	3	3/1	40%	26.6/13.4%	3	11.2x34	2	61.25	860	240	110	358	471	336	61	870	146	

ELECTRIC CHAIN HOIST

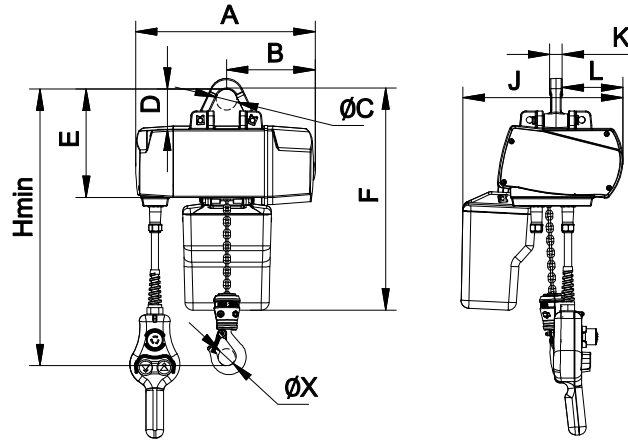

Features:

- Hinged, removable suspension bracket.
- Overload protection by slipping clutch.
- Protection class IP54, Insulation class F.
- Dual lifting speed as standard.
- Operating voltage 220/380/440V, 50/60Hz, 1/3PH.
- Control voltage 24V.
- Pendant control with emergency stop button, protection class IP65.
- Load chain in accordance with standard EN818-7.
- The connection between power supply and control cable is based on aviation plug and socket.
- The electric control system use wear-free semiconductor technology, which is compact and light weight.

ELECTRIC CHAIN HOIST EHE TYPE

Model	Capacity kg	Standard Lift m	Lifting Speed m/min	Hoist Motor kw	Rating %	Load Chain Size mm	Load Chain Falls	Working Group	Proof Load kN	Dimensions(mm)											N.W. kg	Product Code
										A	B	C	D	E	F	Hmin	J	L	K	X		
EHE0125S	125	3	20/5	0.7/0.17	26.6/13.4	4X12	1	M5	1.53	345	170	40	77	208	425	357	306	116	24	24	22	
EHE0250S	250	3	8/2	0.7/0.17	26.6/13.4	4X12	1	M5	3.06	345	170	40	77	208	425	357	306	116	24	24	22	
EHE0500S	500	3	6/1.5	0.7/0.17	26.6/13.4	5X15	1	M5	6.13	345	170	40	77	208	425	388	306	116	24	27	22.6	
EHE1000D	1000	3	3/0.75	0.7/0.17	20/10	5X15	2	M4	12.25	345	170	40	77	208	425	395	306	116	24	29	26.5	
EHE1000S	1000	3	8/2	1.9/0.45	26.6/13.4	7X21	1	M5	12.25	458	204	40	77	263	528	519	427	177	24	45	47.5	
EHE2000D	2000	3	4/1	1.9/0.45	26.6/13.4	7X21	2	M5	24.5	458	204	40	77	263	528	544	427	177	24	45	52.6	

ELECTRIC TROLLEY

Features:

- Compact, robust frame with low overall height.
- Motors protected to IP54 against dust and spray water.
- Wheels manufactured from fracture-proof steel.
- Smooth running due to machined surfaces and ball bearing mounting.
- Cambered profile suitable for parallel and inclined beam profiles.
- Easy adjusted to fit a wide range of beam widths and profiles due to threaded spindles.
- Single or dual travelling speed.

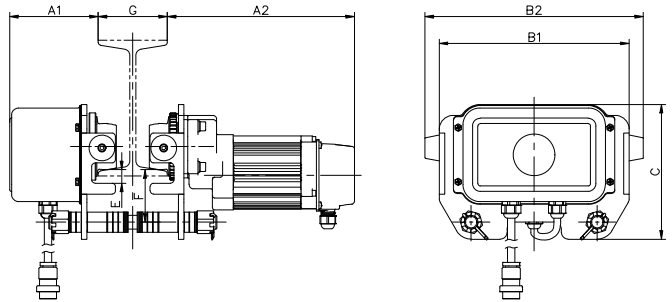

ELECTRIC TROLLEY ETB TYPE

Model	Capacity	Travelling Speed	Motor Power	Min.Radius of Curves	Beam Range(mm)			Dimensions(mm)						N.W.	Product Code
	t	m/min	kw	m	Standard	Optional	A1	A2	B1	B2	C	E	F	kg	
ETB010	1	11	0.15	1	74 - 140	141-200	201-310	131	276	280	322	199	20	77.5	22
		20/5	0.2/0.05												23
ETB020	2	11	0.15	1.2	74 - 140	141-200	201-310	133	278	280	322	205	23.5	77.5	24.5
		20/5	0.2/0.05												25.5
ETB030	3	11	0.3	1.6	100 - 152	153-200	201-310	140	307	346	388	255	25.5	77.5	46
		20/5	0.4/0.1												48
ETB050	5	11	0.3	1.8	100 - 152	153-200	201-310	142	310	346	428	260	27.5	77.5	53.5
		20/5	0.4/0.1												55.5

ELECTRIC TROLLEY

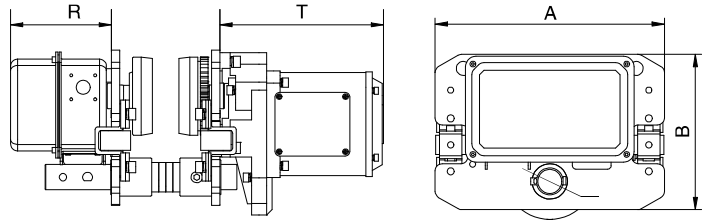

ELECTRIC TROLLEY ETK TYPE

Model	Capacity	Travelling Speed	Motor Power	Beam Range	Dimensions(mm)				Product Code
	t	m/min	kw	mm	A	B	R	T	
ETK005	0.5	11	0.12	75-125	185	195	110	150	
ETK010	1	11	0.4	68-153	315	205	142	231	
ETK020	2	11	0.4	82-178	325	217	142	231	
ETK030	3	11	0.75	100-178	340	250	142	231	
ETK050	5	11	0.75	112-178	400	291	142	231	
ETK075	7.5	11	0.75	112-178	400	291	142	231	
ETK100	10	11	0.75	150-220	500	371	142	231	

ELECTRIC CHAIN HOIST WITH TROLLEY

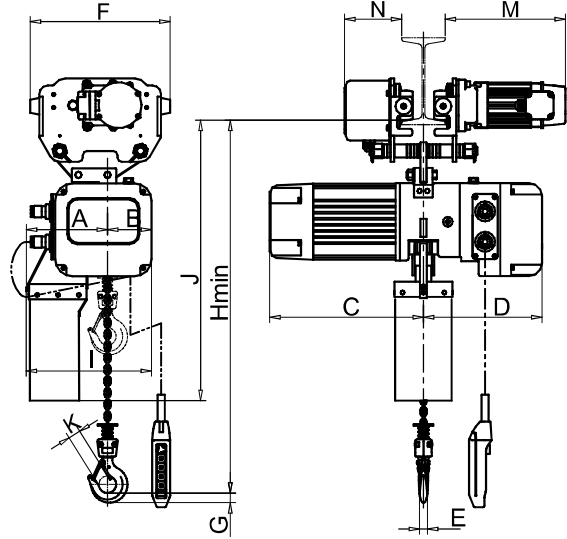

Features:

- Double safety mechanism consisting of overload slipping clutch and upper-lower limit switch.
- Aluminium die cast body and a canvas chain container.
- Uniquely-designed push button control on the basis of ergonomics.
- Electrical and magnetic DC brake.
- Thermal motor protector.
- Control relay is designed to monitor 3-phase power supplies and to protect motor.
- Drop forged alloy hooks are designed to open gradually and not fracture under excessive loads.
- Single or dual lifting speed and traveling speed.
- Operating voltage, 220/380/440V, 50/60Hz, 3PH.
- Control voltage, 24V, 36V or 48V.
- Load chain in accordance with standard EN 818-7.
- Radio remote control(optional).

ELECTRIC CHAIN HOIST WITH TROLLEY EHBT TYPE

Model	Capacity	Lifting Speed	Hoist Motor	Work Group	Duty Rating (ED)		Standard Lift	Load Chain	Load Chain Falls	Proof Load	Traveling Speed		Traveling Motor		Beam Range
	t	m/min	kw				m	mm		kN	m/min	kw	mm		
EHBT0025	0.25	7.0/2.3	0.9/0.3	2m/M5	40%	26.6%/13.4%	3	5x15	1	3.06	11	20/5	0.15	0.2/0.05	74-140
EHBT0050	0.5	7.6/2.5	0.9/0.3	2m/M5	40%	26.6%/13.4%	3	6.3x19	1	6.13	11	20/5	0.15	0.2/0.05	74-140
EHBT0100	1	5.0/1.7	1.1/0.37	2m/M5	40%	26.6%/13.4%	3	8x24	1	12.25	11	20/5	0.15	0.2/0.05	74-140
EHBT0200	2	2.5/0.85	1.1/0.37	2m/M5	40%	26.6%/13.4%	3	8x24	2	24.5	11	20/5	0.15	0.2/0.05	74-140
EHBT0300	3	6.0/2.0	3.6/1.2	2m/M5	40%	26.6%/13.4%	3	11.2x34	1	36.75	11	20/5	0.3	0.4/0.1	100-152
EHBT0500	5	3.0/1.0	3.6/1.2	2m/M5	40%	26.6%/13.4%	3	11.2x34	2	61.25	11	20/5	0.3	0.4/0.1	100-152

Model	Hmin	Dimensions(mm)											N.W.		Product Code
		A	B	C		D	F	J	K	M		N	kg		
	mm			Singe Speed	Dual Speed					Singe Speed	Dual Speed				
EHBT0025	469	190	102	302	334	307	322	630	27	276	276	131	71	95	
EHBT0050	506	190	102	302	334	307	322	630	27	276	276	131	72	96	
EHBT0100	579	190	102	302	354	307	322	630	31	276	276	131	76	100	
EHBT0200	681	223	159	302	354	307	322	631	38	270	315	133	97	111	
EHBT0300	650	282	166	399	469	336	388	757	38	299	322	140	154	180	
EHBT0500	910	338	110	399	469	336	428	820	52	301	324	142	192	222	

ELECTRIC WIRE ROPE HOIST

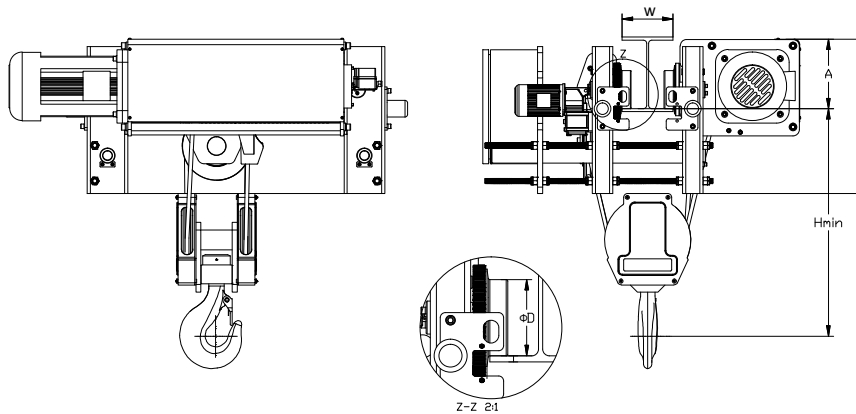
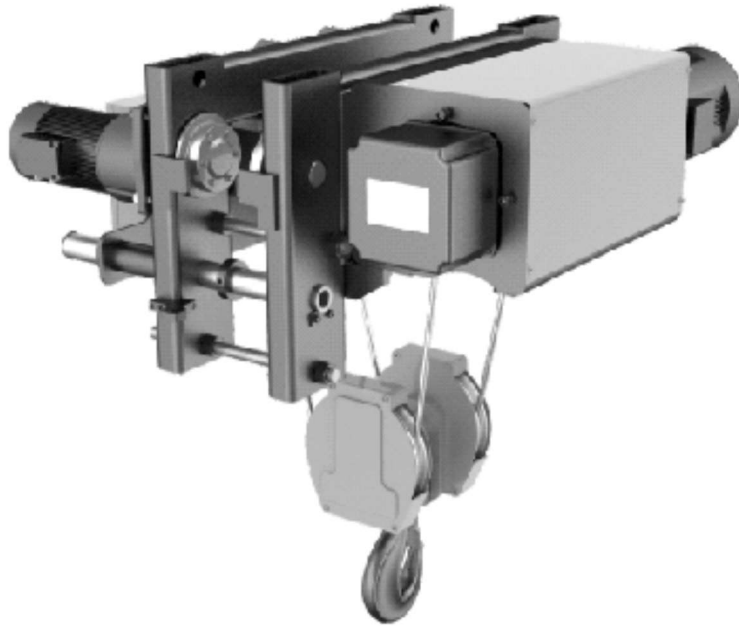

LOW HEADROOM ELECTRIC WIRE ROPE HOIST WHL-B TYPE

Model	Capacity	Working Group	Rope Reeving	Lifting Speed	Lifting Motor	Travelling Speed	Travelling Motor	Rail Width Range W (mm)		Wire Rope Diameter D	A	Hmin	Lifting Height	Product Code
	t			m/min	kw			m/min	kw					
WHL-B4	1.6	M4	2/1	9/2.2	3/0.8	20/5	2*0.37/0.1	100 - 180	100 - 400	8	220	600	12/18/24/30	
	3.2	M4	4/1	4.5/1.1										2*0.37/0.1
WHL-B5	3.2	M4	2/1	8/2	4.5/1.1	20/5	2*0.37/0.1	100 - 180	110 - 460	11	220	750	9/12/18/24	
	6.3	M4	4/1	4/1										2*0.37/0.1
WHL-B6	5	M4	2/1	8/2	7.5/2	20/5	2*0.37/0.1	120 - 180	120 - 460	15	270	950	12/18/24	
	10	M4	4/1	4/1										2*0.75/0.18

 Manual Hoisting
Equipments

 Electric Hoisting
Equipments

 Textile Sling and
Height Safety

 Transport and
Load Restraints

 Lifting Chain/Chain
Sling/Components

 Wire Rope/Wire Rope
Sling/Components

 Forestry and
Rigging Hardware

 Material Handling
Equipments

ELECTRIC WIRE ROPE HOIST

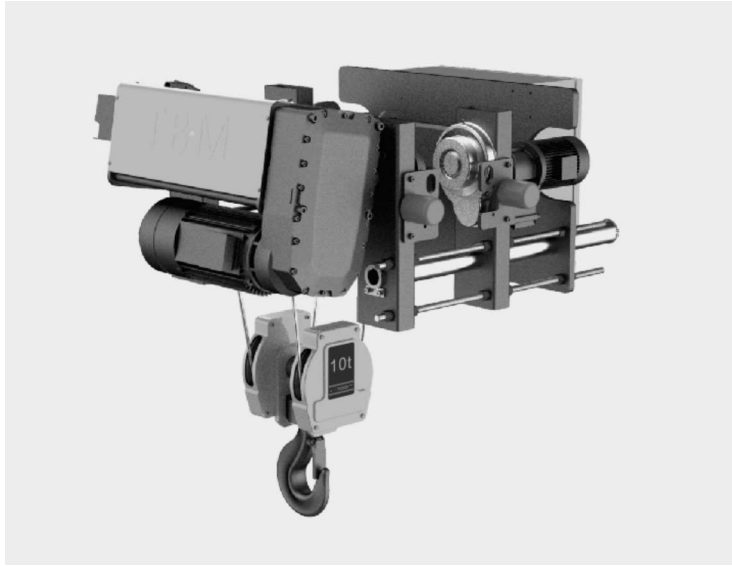

LOW HEADROOM ELECTRIC WIRE ROPE HOIST WHL-D TYPE

Features:

- Electronic unit

Schneider contactor.

Over current protection for motors, phase fault & phase sequence protection to avoid fatal failures.

Three phase voltage 380-415v,50hz(440-480v,60hz).

Control voltage 48V.

Sturdy and durable control panel, Protection class IP54.

- Travelling driving unit

Two direct drive cross travel motors.

Hoist trolleys are fitted with four flanged wheels with permanently lubricated roller bearings, designed for use on tracks with parallel flanges or inclined flanges.

Sturdy pole change aluminium alloy motors with cylindrical rotors and integrated safety brakes. 30% rotational efficiency higher than traditional coupling.

Protection class IP55; insulation class F.

- Hook Assembly

Long service life and high safety levels are outstanding features of the resilient annealed steel rollers with machined rope grooves and annealed load hooks.

- Rope guider

A resilient low-friction plastic rope guide designed as an expanding ring provides positive guidance for the rope. The rope guide also reduces wear on the rope and rope drum. It is also easy to install, reducing maintenance requirements for the unit as a whole.

- Hoisting drive unit

Lightweight gear units with silent running flat bevelled gears deliver the torque required.

Protection class IP55; insulation class F.

Sturdy pole change aluminium alloy motors with cylindrical rotors and integrated safety brakes.

With thermal protection device and overload protection device.

Cam limit switch is provided for lifting the Up and Down motion. Up position is factory set while Down position is easy to set at site.

The dual-disk electromagnetic DC brake features automatic braking in the event of a power failure. Asbestos free brake linings designed for approx. 1 million braking operations make for long maintenance intervals.

- Drum and Wire Rope

Drum is made from seamless steel pipe. High precision machine grooves effectively extend service life of wire rope.

Heavy duty galvanized wire rope with tensile strength 2160N/mm².

- Frequency inverter for lifting or travelling (optional).

- Remote control(optional).

ELECTRIC WIRE ROPE HOIST

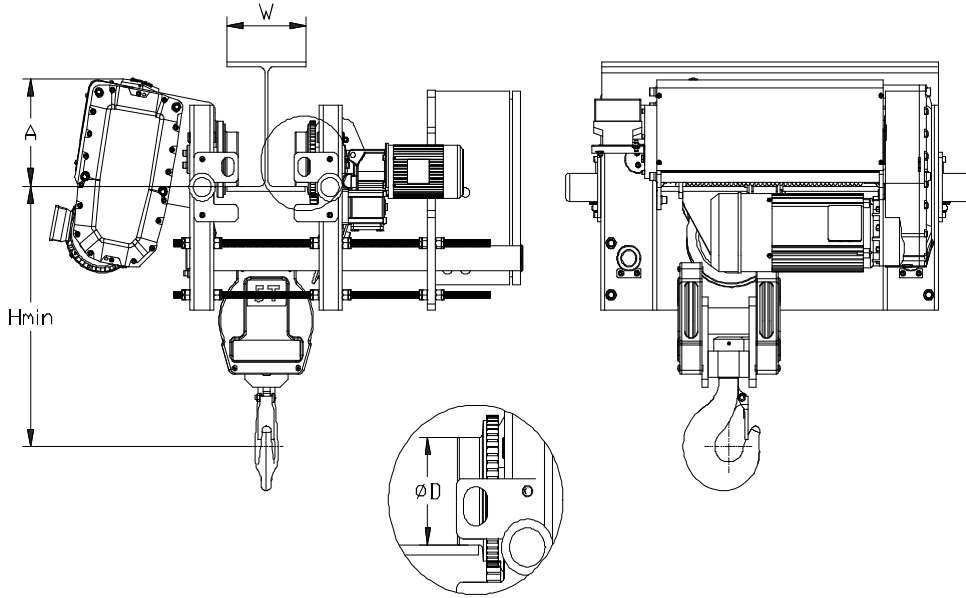

LOW HEADROOM ELECTRIC WIRE ROPE HOIST WHL-D TYPE

Model	Capacity	Working Group	Rope Reeving	Lifting Speed	Lifting Motor	Travelling Speed	Travelling Motor	Rail Width Range W(mm)		Rope Diameter	Wheel Diameter D	A	Hmin	Lifting Height	Product Code
	t			m/min	kw			I-Beam	H-Beam						
WHL-D2	1	M7	2/1	10/1.6	3.2/0.45	20/5	2*0.37/0.1	100-180	100-400	7	100	220	600	12/18/24/30	
	1.25	M6	2/1	10/1.6											
	1.6	M5	2/1	10/1.6											
	2	M7	4/1	5/0.8											
	2.5	M6	4/1	5/0.8											
WHL-D3	3.2	M5	4/1	5/0.8	6.0/0.9	20/5	2*0.37/0.1	110-180	110-460	9	125	249	700	12/18/24/30	
	2	M6	2/1	10/1.6											
	2.5	M5	2/1	10/1.6											
	3.2	M4	2/1	10/1.6											
	4	M6	4/1	5/0.8											
WHL-D4	5	M5	4/1	5/0.8	9.5/1.5	20/5	2*0.37/0.1	120-180	120-460	13	150	336	900	12/18/24/30	
	4	M6	2/1	10/1.6											
	6.3	M4	2/1	10/1.6											
	8	M6	4/1	5/0.8											
	10	M5	4/1	5/0.8											
	12.5	M4	4/1	5/0.8	12.5/1.9		2*0.75/0.18					800	6/9/12/15		

ELECTRIC WIRE ROPE HOIST

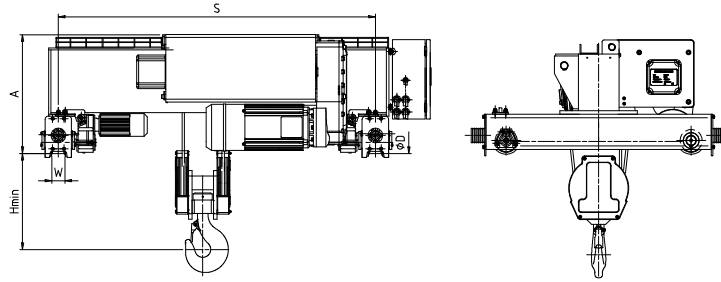
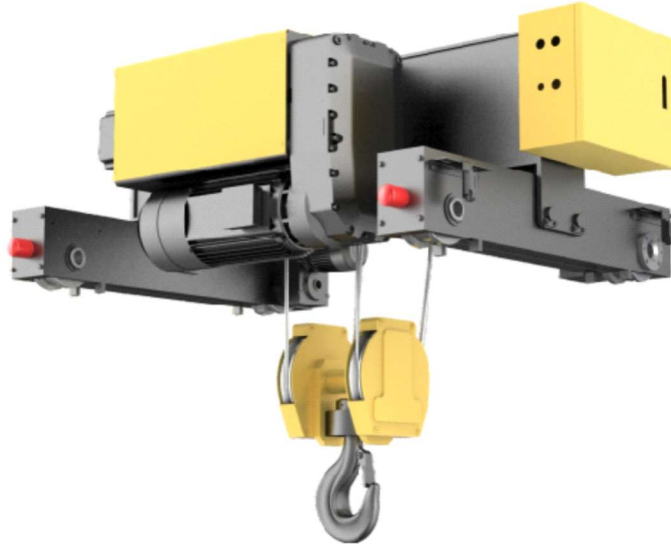

DOUBLE GIRDER ELECTRIC WIRE ROPE HOIST WHD-D TYPE

Item No.	Capacity	Working Group	Rope Reeving	Lifting Speed	Lifting Motor	Travelling Speed	Travelling Motor	Wheel Diameter D	Hmin	A	W	Rail Gauge S	Lifting Height	Product Code
	t			m/min	kw	m/min	kw							
WHD-D3	2.5	M5	2/1	10/1.6	6/0.9	0-20	2*0.37	125	450	550	65	1200-2000	12-30	
	5	M5	4/1	5/0.8	6/0.9	0-20	2*0.37	125	350	550	65	1200-2000	6-15	
WHD-D4	5	M5	2/1	10/1.6	9.5/1.5	0-20	2*0.37	125	600	650	65	1400-2300	12-30	
	10	M5	4/1	5/0.8	9.5/1.5	0-20	2*0.55	125	500	650	65	1400-2300	6-15	
WHD-D5	10	M5	2/1	8/2	16/2.6	0-20	2*0.55	125	750	780	65	1400-2700	12-40	
	20	M5	4/1	4/1	16/2.6	0-20	2*1.1	160	750	800	75	1400-2700	6-20	
	20	M5	8/2	4/1	16/2.6	0-20	2*1.1	160	900	800	75	1700-3000	10-20	
	32	M5	12/2	2.7/0.67	16/2.6	0-20	2*1.5	200	1200	900	85	1700-3000	6.5-13	
	40	M5	8/2d	4/1	2*16/2.6	0-20	2*2.2	250	1000	1100	90	1700-3400	6-20	
WHD-D6	50	M5	10/2d	3.2/0.8	2*16/2.6	0-20	2*3	315	1300	1150	95	1700-3400	7-16	
	16	M5	2/1	0-9.8	38	0-20	2*1.1	160	1000	1000	75	1700-3000	12-45	
	32	M5	4/1	0-4.9	38	0-20	2*1.5	200	1000	1100	85	1700-3000	6-22.5	
	32	M5	8/2	0-4.9	38	0-20	2*1.5	200	900	1100	85	2000-3400	9-22.5	
	50	M5	12/2	0-3.3	38	0-20	2*3	315	1500	1200	95	2000-3400	6-15	
	63	M5	16/2	0-2.45	38	0-20	2*4	400	2500	1200	105	2000-3400	4.5-11	
	63	M5	8/2d	0-4.9	2*38	0-20	2*4	400	1200	1400	105	2000-3400	6-22.5	
80	M5	10/2d	0-3.9	2*38	0-20	2*4	400	2000	1400	105	2000-3400	7-18		

ELECTRIC WIRE ROPE HOIST

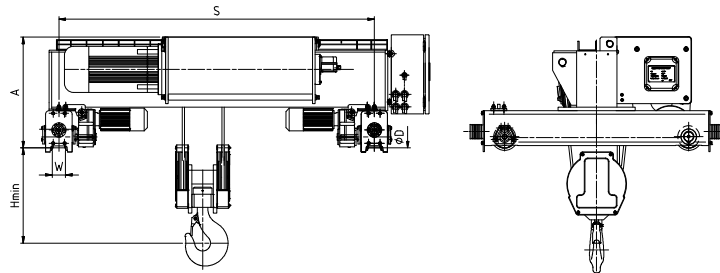
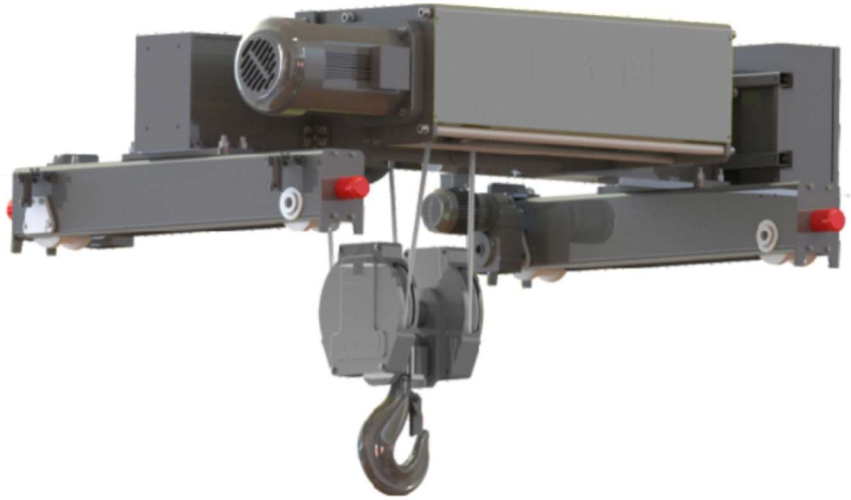

DOUBLE GIRDER ELECTRIC WIRE ROPE HOIST WHD-B TYPE

Model	Capacity	Working Group	Rope Reeving	Lifting Speed	Lifting Motor	Travelling Speed	Travelling Motor	Wheel Diameter D	Hmin	A	W	Rail Gauge S	Lifting Height	Drum Diameter	Rope Diameter	Product Code
	t			m/min	kw											
WHD-B5	3	M4	2/1	8/2	4.5/1.1	0-20	2*0.37	125	450	550	65	1200-2000	12-30	247	11	
	6.3	M4	4/1	4/1				125	350	550	65	1200-2000	6-15			
WHD-B6	5	M4	2/1	8/2	7.5/2	0-20	2*0.37	125	600	650	65	1400-2300	12-30	275	15	
	10	M4	4/1	4/1				125	500	650	65	1400-2300	6-15			
WHD-B7	10	M4	2/1	7/1.8	13/3.4	0-20	2*0.55	125	750	780	65	1400-2600	9-36	327	18	
	20	M4	4/1	3.5/0.9				160	750	800	75	1400-2600	6-18			
	20	M4	8/2	3.5/0.9				160	900	800	75	1700-3000	9-18		11	
	30	M4	12/2	2.3/0.6				200	1200	900	85	1700-3000	6-12			
WHD-B9	16	M4	2/1	6/1.5	18.5/4.6	0-20	2*0.75	160	1000	1000	75	1700-3000	12-45	405	20	
	32	M4	4/1	3/0.75				200	1000	1100	85	1700-3000	6-22.5			
	32	M4	8/2	3/0.75				200	900	1100	85	2000-3400	9-22.5		15	
	48	M4	12/2	2/0.5				250	1500	1200	90	2000-3400	6-15			

ELECTRIC WIRE ROPE HOIST



ELECTRIC WIRE ROPE HOIST WHF-B TYPE

Item No.	Capacity	Working Group	Rope Reeving	Lifting Speed	Lifting Motor	Wire Rope Diameter	Lifting Height	Product Code
	t			m/min	kw		m	
WHF-B4	1.6	M4	2/1	9/2.2	3/0.8	8	9/12/18/24/30	240604016
	3.2	M4	4/1	4.5/1.1	3/0.8	8	6/9/12/15	240604030
WHF-B5	3.2	M4	2/1	8/2	4.5/1.1	11	9/12/18/24/30	240605030
	6.3	M4	4/1	4/1	4.5/1.1	11	6/9/12/15	240605063
WHF-B6	5	M4	2/1	8/2	7.5/2	15	9/12/18/24/30	240606050
	10	M4	4/1	4/1	7.5/2	15	6/9/12/15	240606100
WHF-B7	10	M4	2/1	7/1.8	13/3.4	18	9/12/18/24/30	240607100
	20	M4	4/1	3.5/0.9	13/3.4	18	6/9/12/15	240607200

Features:

- DC Brake

New design of DC brake electromagnetic motor disc system works precisely and synchronously with motors, and with a rectifier for trouble free, rapid reaction with low noise & durable wear.

- Motor

Highly efficiently squirrel cage motor are quiet, small volume, light weight. Protection class IP54. Insulation class F. With thermal protection device.

- Control Panel

Schneider contactor.

Sturdy and durable control panel, protection class Ip54.

Over current protection for motors, phase fault & phase sequence protection to avoid fatal failures.

Three phase voltage 380-415v,50hz(440-480v,60hz), control voltage 48V.

- Gearbox

Hoist reduction gear system are made of alloy steel with surface harden treatment for long lasting life span. The planetary gearbox has advantages of light weight, compact size, high efficiency, stable operation and low noise.

Overload protection fitted as standard for increased safety.

Operation via pendant control handset complete with emergency stop button.

- Frequency inverter for lifting or travelling (optional).

- Remote control (optional) .

ELECTRIC WINCH & CRANE ACCESSORIES

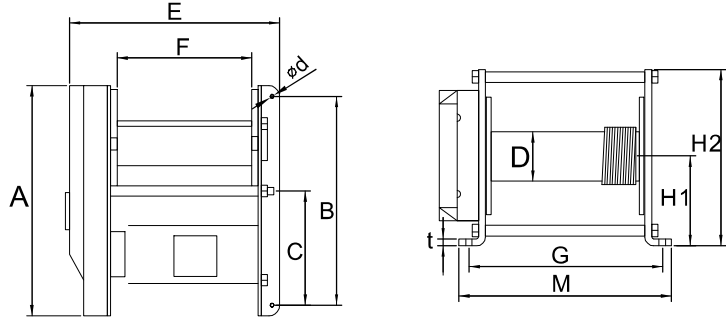

Features:

- The extremely compact, practical cube design and universal rope lead-offs allow individual applications in almost any position and this makes them powerful aids for lifting and pulling loads.
- Compact dimensions due to internal brake motor.
- Spur gear transmission with helical first gear - ensures smooth motion.
- Spring pressure disc brake incorporated in the motor holds the load securely even in the event of a power failure.
- A plain rope drum is supplied as standard.
- The rope is secured to the drum in a recess, so that the rope can be wound onto the drum in several layers without damage.
- Low voltage pendant control is supplied as standard. Protection class: IP65

ELECTRIC WINCH EWA TYPE

Model	Capacity kg	Lifting Height m	Lifting Speed m/min	Rope mm	Power Supply	Dimensions(mm)												N.W. kg	Product Code
						A	B	C	D	d	E	F	G	H1	H2	M	t		
EWA250-15	250	58	30	5	230v1ph/50hz	436	295	--	83	13	380	265	322	147	305	345	8	65	
EWA500-15	500	58	20	6		520	480	240	122	15	415	270	338	188	372	370	10	107	
EWA250-30	250	58	30	5	400v3ph/50hz	436	295	--	83	13	380	265	322	147	305	345	8	65	
EWA500-30	500	58	20	6		520	480	240	122	15	415	270	338	188	372	370	10	107	

CRANE ACCESSORIES

Remote Control



Conductor System

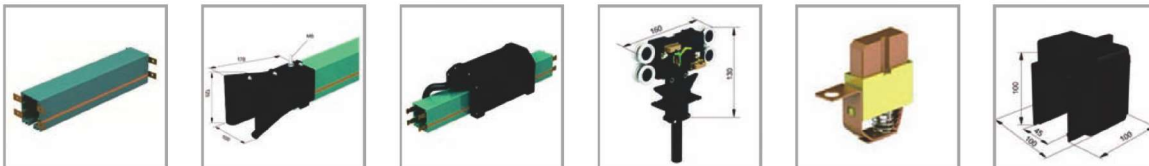

Festoon System



FLAT WOVEN WEBBING SLING EN1492-1





Features:

- Flat woven webbing slings, also commonly known as belt slings, are used for a variety of lifting purposes.
- Made from high-tenacity polyester yarn (PES), resistant to most acids but not to strong alkalis.
- Duplex construction, PU-impregnated, thermally fixed.
- With reinforced soft eyes.
- Colour coded for easy capacity recognition.
- Capacity stripes: each stripe is equal to 1 tonne capacity.
- Low elongation, lightweight and flexible.
- It is less damaging on contacting load surfaces than metal slings.
- Each sling is marked with a unique serial number for safe sling registration.
- Year/Month calendar printed on the label where next inspection date can be marked or punched.
- Standard: EN 1492-1
- Safety factor: 7:1

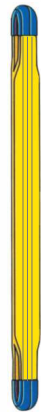

DOUBLE PLY FLAT WOVEN WEBBING SLING



Item No.	Colour Coded According to EN14921	Width (mm)	Working Load Limit (t)					Product Code
			Straight Lift	Choked Lift	Basket Hitch			
					Parallel	$\beta=0^\circ-45^\circ$	$\beta=45^\circ-60^\circ$	
								
			1	0.8	2	1.4	1	
WS01-03001	WLL 1T	30/50	1	0.8	2	1.4	1	
WS01-06002	WLL 2T	60	2	1.6	4	2.8	2	
WS01-09003	WLL 3T	90	3	2.4	6	4.2	3	
WS01-12004	WLL 4T	120	4	3.2	8	5.6	4	
WS01-15005	WLL 5T	150	5	4	10	7	5	
WS01-18006	WLL 6T	180	6	4.8	12	8.4	6	
WS01-24008	WLL 8T	240	8	6.4	16	11.2	8	
WS01-30010	WLL 10T	300	10	8	20	14	10	
WS01-30012	WLL 12T	300	12	9.6	24	16.8	12	

- Option:
 1. SF5:1, SF6:1 are also available.
 2. Additional load capacities available



ROUNDSLING EN1492-2

ENDLESS ROUNDSLING

- A roundsling is a sling comprising a core enclosed in a protective cover.
- Made from high-tenacity polyester yarn (PES).
- Roundsling sleeve is made by extra strong PU-impregnated webbing.
- Colour coded for easy capacity recognition. Black roundslings are also available.
- Capacity stripes: each stripe is equal to 1 tonne capacity.
- Low elongation, extremely lightweight, flexible and pliable.
- It is less damaging on contacting load surfaces than metal slings.
- Standard: EN 1492-2 & AS 4497.1
- Safety factor : 7:1

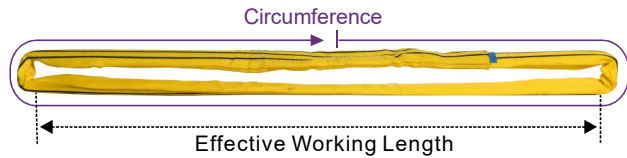

Item No.	Colour Coded According to EN14922	Working Load Limit (t)							Product Code
		Straight Lift	Choked Lift	Basket Hitch					
				Parallel	$\beta=0^{\circ}-45^{\circ}$	$\beta=45^{\circ}-60^{\circ}$	$\beta=0^{\circ}-45^{\circ}$	$\beta=45^{\circ}-60^{\circ}$	
		1	0.8	2	1.4	1	0.7	0.5	
RS01-001	WLL 1T	1	0.8	2	1.4	1	0.7	0.5	
RS01-002	WLL 2T	2	1.6	4	2.8	2	1.4	1	
RS01-003	WLL 3T	3	2.4	6	4.2	3	2.1	1.5	
RS01-004	WLL 4T	4	3.2	8	5.6	4	2.8	2	
RS01-005	WLL 5T	5	4	10	7	5	3.5	2.5	
RS01-006	WLL 6T	6	4.8	12	8.4	6	4.2	3	
RS01-008	WLL 8T	8	6.4	16	11.2	8	5.6	4	
RS01-010	WLL 10T	10	8	20	14	10	7	5	
RS01-012	WLL 12T	12	9.6	24	16.8	12	8.4	6	
RS01-015	WLL 15T	15	12	30	21	15	10.5	7.5	
RS01-020	WLL 20T	20	16	40	28	20	14	10	
RS01-025	WLL 25T	25	20	50	35	25	17.5	12.5	
RS01-030	WLL 30T	30	24	60	42	30	21	15	
RS01-035	WLL 35T	35	28	70	49	35	24.5	17.5	
RS01-040	WLL 40T	40	32	80	56	40	28	20	
RS01-045	WLL 45T	45	36	90	63	45	31.5	22.5	
RS01-050	WLL 50T	50	40	100	70	50	35	25	
RS01-060	WLL 60T	60	48	120	84	60	42	30	
RS01-080	WLL 80T	80	64	160	112	80	56	40	
RS01-100	WLL 100T	100	80	200	140	100	70	50	
RS01-120	WLL 120T	120	96	240	168	120	84	60	
RS01-200	WLL 200T	200	160	400	280	200	140	100	

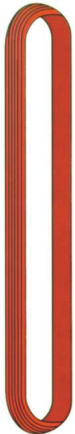



ROUNDSLING EN1492-2, AS4497.1

TOWING SLING



Item No.	MBS(t)	Length(m)	Product Code
TS-0806	8	6	
TS-1206	12	6	
TS-1606	16	6	
TS-1806	18	6	
TS-2406	24	6	
TS-2806	28	6	
TS-3606	36	6	
TS-4206	42	6	
TS-4806	48	6	
TS-5606	56	6	
TS-6006	60	6	

- Towing slings are used for heavier machines like forest machines, load vehicles, excavators.
- Light weight and good shock absorption make it flexible and safe to use.
- Provided with a sleeve.
- Marked with information about breaking load in straight pull.
- Standard length is 6m, other lengths available to customer request.
- Both eyes have an extra protection against abrasion.
- Not to be used for lifting.

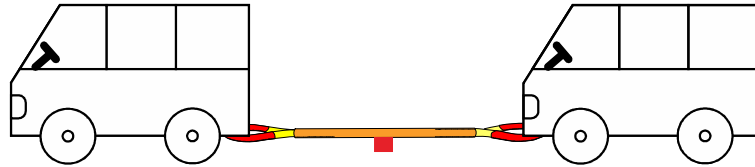

ROUNDSLING ASSEMBLY

Features:

- 1-, 2-, 3- and 4-leg assemblies are suitable for all kinds of lifting.
- A lighter alternative compared to a chain sling or wire rope sling assembly.
- 100 % polyester roundsling according to EN 1492-2.
- High-strength hardware according to EN 1677.
- Safety factor: 4 : 1

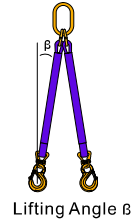

NOTE: option:  NFC identification

1-LEG ROUNDSLING ASSEMBLY

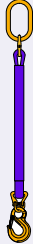
Item No.		WLL (t)	Product Code
RSA-1-1		1	
RSA-1-2		2	
RSA-1-3		3	
RSA-1-4		4	
RSA-1-5		5	

2-LEG ROUNDSLING ASSEMBLY

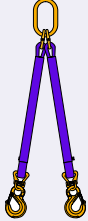
Item No.		WLL (t)	WLL (t)	Product Code
		Lifting Angle β	Lifting Angle β	
		0-45°	45-60°	
RSA-2-1		1.4	1	
RSA-2-2		2.8	2	
RSA-2-3		4.2	3	
RSA-2-4		5.6	4	
RSA-2-5		7	5	

3-LEG ROUNDSLING ASSEMBLY

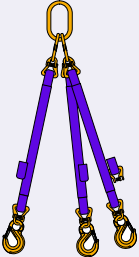
Item No.		WLL (t)	WLL (t)	Product Code
		Lifting Angle β	Lifting Angle β	
		0-45°	45-60°	
RSA-3-1		2.1	1.5	
RSA-3-2		4.2	3	
RSA-3-3		6.3	4.5	
RSA-3-4		8.4	6.0	
RSA-3-5		10.5	7.5	

4-LEG ROUNDSLING ASSEMBLY

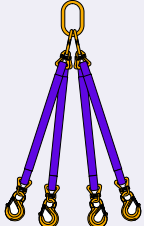
Item No.		WLL (t)	WLL (t)	Product Code
		Lifting Angle β	Lifting Angle β	
		0-45°	45-60°	
RSA-4-1		2.1	1.5	
RSA-4-2		4.2	3	
RSA-4-3		6.3	4.5	
RSA-4-4		8.4	6.0	
RSA-4-5		10.5	7.5	

RATCHET STRAP EN12195-2

 Manual Hoisting
Equipments

 Electric Hoisting
Equipments

 Textile Sling and
Height Safety

 Transport and
Load Restraints



 Lifting Chain/Chain
Sling/Components

 Wire Rope/Wire Rope
Sling/Components

 Forestry and
Rigging Hardware

 Material Handling
Equipments

35MM/2T RATCHET TIE DOWN

	Item No.	Length (m)	End Fitting	LC (daN)	MBS (kg)	Product Code
	HFL-RTD3520DJ	0.5 + 5.5	Double J Hook	1000	2000	
	HFL-RTD3520SJ	0.5 + 5.5	Single J Hook	1000	2000	
	HFL-RTD3520CK	0.5 + 5.5	Claw Hook	1000	2000	
	HFL-RTD3520TG	0.5 + 5.5	Triangle	1000	2000	



50MM/4T/5T RATCHET TIE DOWN

	Item No.	Length (m)	End Fitting	LC (daN)	MBS (kg)	Product Code
	HFL-RTD5040DJ	0.5 + 9.5	Double J Hook	2000	4000	
	HFL-RTD5050DJ			2500	5000	
	HFL-RTD5040SJ	0.5 + 9.5	Single J Hook	2000	4000	
	HFL-RTD5050SJ			2500	5000	
	HFL-RTD5040CK	0.5 + 9.5	Claw Hook	2000	4000	
	HFL-RTD5050CK			2500	5000	
	HFL-RTD5040TG	0.5 + 9.5	Triangle	2000	4000	
	HFL-RTD5050TG			2500	5000	



50MM/4T/5T ERGO RATCHET TIE DOWN

	Item No.	Length (m)	End Fitting	LC (daN)	MBS (kg)	Product Code
	HFL-ERTD5040DJ	0.5 + 9.5	Double J Hook	2000	4000	
	HFL-ERTD5050DJ			2500	5000	
	HFL-ERTD5040SJ	0.5 + 9.5	Single J Hook	2000	4000	
	HFL-ERTD5050SJ			2500	5000	
	HFL-ERTD5040CK	0.5 + 9.5	Claw Hook	2000	4000	
	HFL-ERTD5050CK			2500	5000	
	HFL-ERTD5040TG	0.5 + 9.5	Triangle	2000	4000	
	HFL-ERTD5050TG			2500	5000	

RATCHET STRAP EN12195-2







75MM/10T RATCHET TIE DOWN

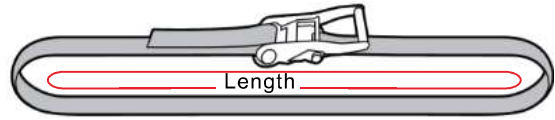

	Item No.	Length (m)	End Fitting	LC (daN)	MBS (kg)	Product Code
	HFL-RTD75100DJ	0.5 + 9.5	DoubleJ Hook	5000	10000	
	HFL-RTD75100CK	0.5 + 9.5	Claw Hook	5000	10000	

ENDLESS TIE DOWN ASSEMBLY



	Item No.	Width /Length	Tensioning Device	LC (daN)	MBS (kg)	Product Code
	HFL-EL-25-0.25T	25mm / 5m	Cam	125	250	
	HFL-EL-25-0.3T			150	300	
	HFL-EL-25-0.4T			200	400	
	HFL-EL-25-0.5T			250	500	
	HFL-EL-25-1.6T	25mm / 5m	Ratchet	800	1600	
	HFL-EL-25-2T			1000	2000	
	HFL-EL-28-3T	28mm / 6m	Ratchet	1500	3000	
	HFL-EL-35-4T	35mm / 6m	Ratchet	2000	4000	
	HFL-EL-35-6T			3000	6000	
	HFL-EL-50-8T	50mm / 8m	Ratchet	4000	8000	
	HFL-EL-50-10T			5000	10000	
	HFL-EL-75-20T	75mm / 10m	Ratchet	10000	20000	

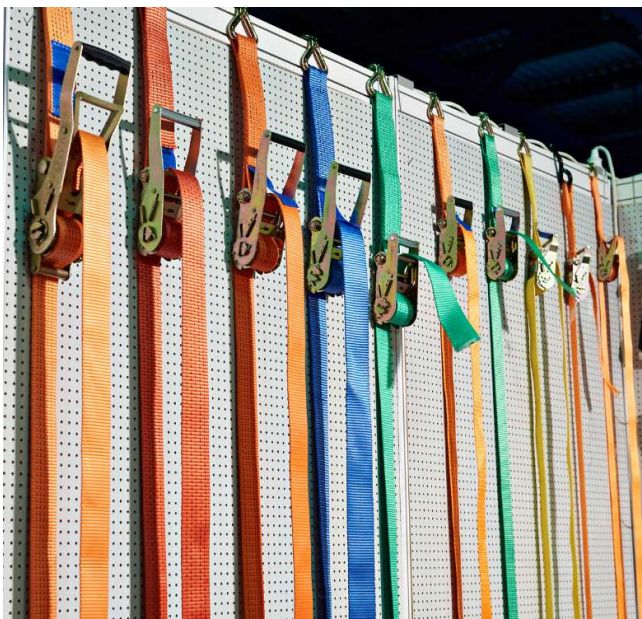

CORNER PROTECTOR

CORNER PROTECTOR



PCP102

Material: PE
Size: 90x90x136(83°)
For 50~100mm Webbing
Product Code: 40600005



PCP057

Material: PE
Size: 150x195x150(90°)
For 50mm Webbing
Product Code: 406000011



PS006

Material: PU
Size: 4x80x125
For 50mm Webbing
Product Code: 406000022



ROUND SLEEVE

with fabric insert and PU coating.

Manual Hoisting
Equipments

Electric Hoisting
Equipments

Textile Sling and
Height Safety

Transport and
Load Restraints

Lifting Chain/Chain
Sling/Components

Wire Rope/Wire Rope
Sling/Components

Forestry and
Rigging Hardware

Material Handling
Equipments

LOAD BINDER

 Manual Hoisting
Equipments

 Electric Hoisting
Equipments

 Textile Sling and
Height Safety

 Transport and
Load Restraints

 Lifting Chain/Chain
Sling/Components

 Wire Rope/Wire Rope
Sling/Components

 Forestry and
Rigging Hardware

 Material Handling
Equipments

Features:

Load binders are used for the safe securing of heavy loads by road, rail, air and ship transport.

- ELBH load binder is individually proof load tested at 1.25 times the lashing capacity.
- The closed body design protects the threads from damage and prevent dirt from entering into the body.
- Forged eye bolts and hooks.
- Hooks are equipped with safety pins to prevent unintentional unhooking.
- Safety device prevents unintentional unscrewing.
- Powder coated finish for good corrosion protection.
- In combination with Grade 80 chain.
- Marking: size, lashing capacity, "Not for lifting", batch No., EN 12195-3
- Standard: EN 12195-3
- Warning: not for lifting.

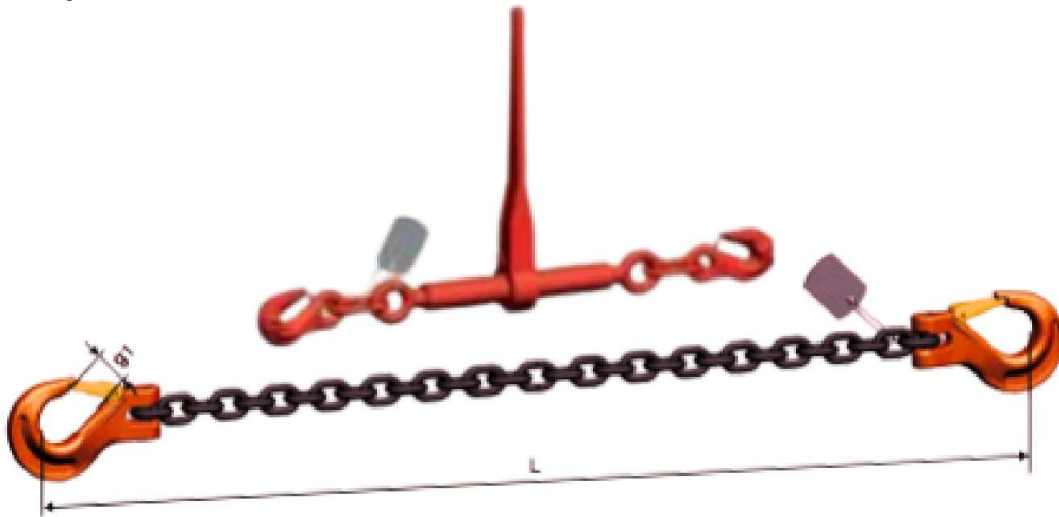

GRADE 80 LASHING CHAIN ASSEMBLY FOR RATCHET LOAD BINDER

Item No.	Chain Size	LC	MBF	Standard Length	Weight	Product Code
	mm	kN	kN	m	kg	
LCLB08	8	40	80.4	3.5	6.1	
LCLB10	10	63	126	3.5	9.8	
LCLB13	13	100	212	3.5	16.1	
LCLB16	16	160	322	3.5	25.4	

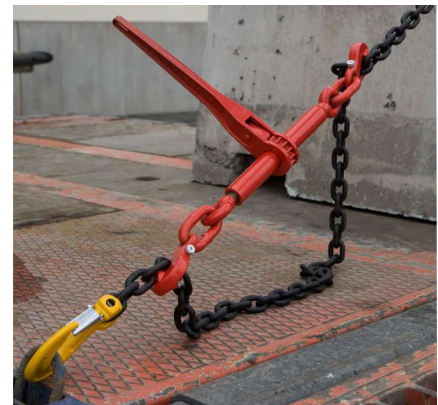

- For lashing extremely heavy items on boats, carriages, etc.
- Standard end fitting: Grade 80 clevis sling hook with safety latch
- Surface finish of chain: electro galvanized, black painted or black E-coated.



LOAD BINDER

RATCHET TYPE LOAD BINDER WITH WINGED GRAB HOOK AND SAFETY PIN

Item No.	Chain Size	LC	MBF	Dimensions (mm)					Weight	Product Code
	mm	kN	kN	A	B	F	F1	M	kg	
ELBH08	8	40	80.4	252	11.5	575	740	355	4.5	
ELBH10	10	63	126	252	15	615	780	355	5.5	
ELBH13	13	100	212	252	19.5	695	850	355	8	
ELBH16	16	160	322	430	19.5	930	1230	355	14.5	

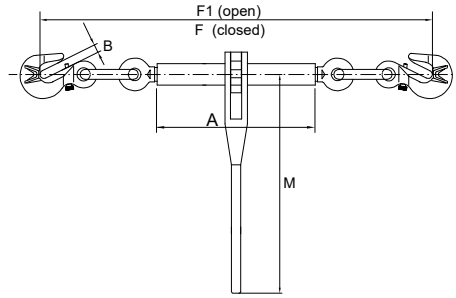

RATCHET TYPE LOAD BINDER WITHOUT LINKS OR HOOKS

Item No.	Min.-Max. Chain Size	Working Load Limit	Proof Load	Minimum Ultimate Load	Weight	Handle Length	Dimensions (mm)					Product Code
	mm	kg	kg	kg	kg	mm	L	A	E	E1	D	
RLBN08	6-8	2000	2500	4000	0.98	190	170	164	220	320	14.5	
RLBN10	8-10	4300	5400	8600	3.1	386	345	250	330	480	20	
RLBN13	10-13	7500	9400	15000	3.1	386	345	250	330	480	20	
RLBN16	13-16	10500	13000	21000	3.5	386	345	250	350	500	26	

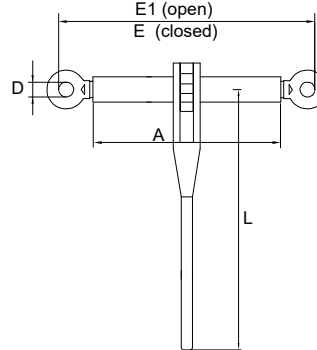

GRADE 80 LASHING CHAINS WITH RATCHET LOAD BINDER

Item No.	Chain Size	LC	MBF	K	Product Code
	mm	kN	kN	mm	
ELBC08	8	40	80.4	29	
ELBC10	10	63	126	39	
ELBC13	13	100	212	47.5	



-The lashing chains are equipped with a ratchet load binder, load hooks with safety latches, shortening grab hook with safety pin that prevents the chain from vibrating during transport.

-The ratchet load binder applies a force to the chains in a controlled manner.

-Long side can be shortened safely by the shortening grab hook.

-Standard working length 3.5m.

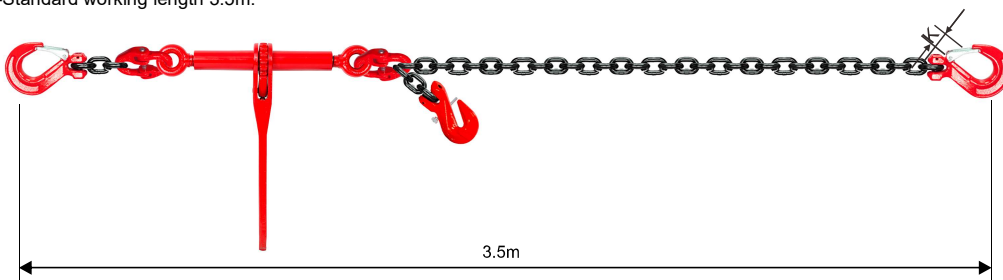

G100 RATCHET LOAD BINDER

Specification

A ratchet chain load binder is a tool used to tighten and secure chains around a load for transportation purposes. It is commonly used in applications such as trucking, flatbed trailers, and other cargo securing scenarios. The purpose of the load binder is to prevent the load from shifting or coming loose during transit.

Here's a general overview of how a ratchet chain load binder typically works:

- **Components:** A ratchet chain load binder typically consists of a handle, two tension hooks, and a ratcheting mechanism.
- **Installation:** The load binder is installed by attaching one end of the chain to the anchor point on the truck or trailer and the other end to the load. The load binder is then positioned over the chain.
- **Tensioning:** The ratcheting mechanism is operated by turning the handle, which pulls the two ends of the chain closer together, creating tension. This helps secure the load tightly.
- **Locking:** Once the desired tension is achieved, the ratcheting mechanism often has a locking feature to keep the binder in place and maintain the tension on the chain.
- **Safety Measures:** It's crucial to follow the manufacturer's instructions and safety guidelines when using ratchet chain load binders. Over-tightening can be dangerous and may damage the load or equipment.
- **Working Load Limit (WLL):** Each load binder is rated for a specific Working Load Limit (WLL), which is the maximum load the binder is designed to handle safely. It's essential to use a load binder with an appropriate WLL for the intended load.

Features:

- Standard: EN 12195-3
- Material: Grade 100
- Lashing Capacity: 50kN, 80kN and 134kN
- Chain Size: 8mm, 10mm and 13mm
- Attachment: Shortening grab hook and locking pin
- Forged handle
- Suitable for use with Grade 100 chain.
- Only for lashing, not for lifting
- Finish: powder coated

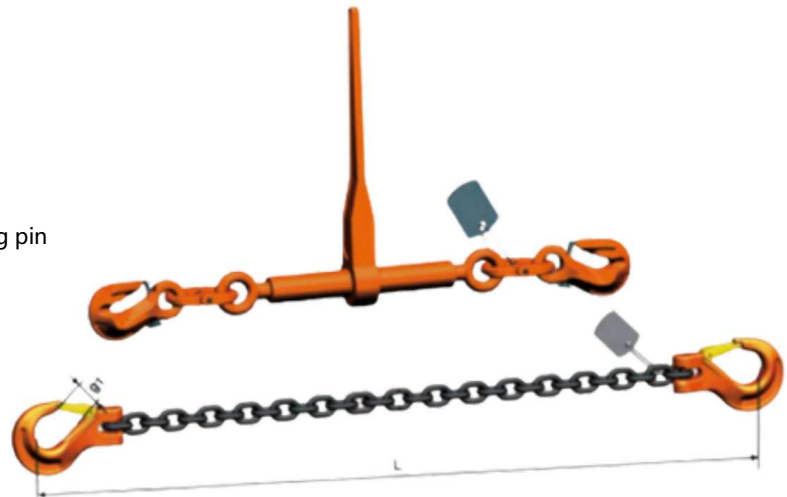

GRADE 100 LASHING CHAIN ASSEMBLY FOR RATCHET LOAD BINDER

Item No.	Chain Size	LC	MBF	Standard Length	Weight	K	Product Code
	mm	kN	kN	m	kg	mm	
LCLP08	8	50	100	3.5	6.1	25	
LCLP10	10	80	160	3.5	9.8	28	
LCLP13	13	134	268	3.5	16.1	38	
LCLP16	16	200	400	3.5	25.4	44	

- For lashing extremely heavy items on boats, carriages, etc.
- Standard end fitting: Grade 100 clevis sling hook with safety latch
- Surface finish of chain: electro galvanized, black painted or black E-coated.



G100 RATCHET LOAD BINDER

GRADE 100 RATCHET LOAD BINDER WITH GRAB HOOKS, RLHP TYPE

Item No.	Chain Size	LC	MBF	Dimensions (mm)								Weight	Product Code	
	mm	kN	kN	A	D	H	E	L	ϕ	ϕ'	L _{min}	L _{max}		kg
ELHP08	8	50	100	50	12	98	10.5	383	56	28	340	502	3.78	
ELHP10	10	80	160	50	14	121.5	13	388.5	65	33.1	365	525	5.8	
ELHP13	13	134	268	72	20	159.5	15.5	392.5	69	37.1	365	525	9.5	

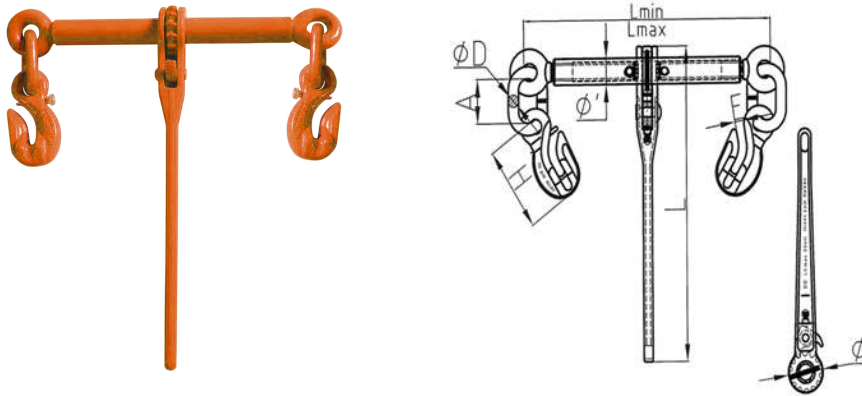

GRADE 100 RATCHET LOAD BINDER WITHOUT LINKS OR HOOKS, RLWLTYPE

Item No.	Chain Size	LC	MBF	Dimensions (mm)						Weight	Product Code
	mm	kN	kN	A	L	ϕ	ϕ'	L _{min}	L _{max}	kg	
RLWL08	8	50	100	50.5	383	56	25	340	500	2.6	
RLWL10	10	80	160	66	388.5	65	34	376	536	4.3	
RLWL13	13	134	268	81	392.5	69	43.5	395	555	5	

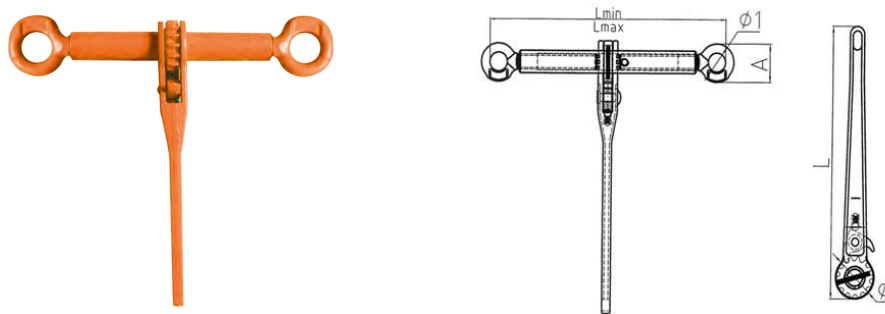

GRADE 100 LASHING CHAINS WITH RATCHET LOAD BINDER

Item No.	Chain Size	LC	MBF	L	K	Product Code
	mm	kN	kN	mm	mm	
ELBP08	8	50	100	3500	25	
ELBP10	10	80	160	3500	28	
ELBP13	13	134	268	3500	38	

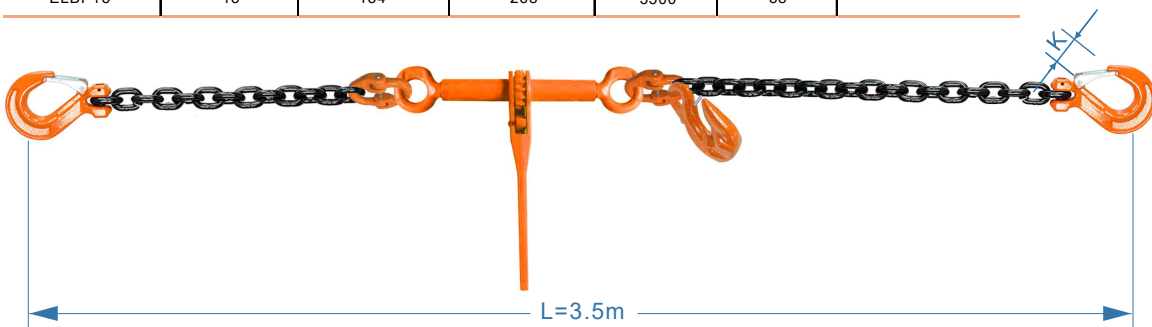

CHAIN SLING SELECTION

In this catalogue the maximum working load limit for each size of chain is shown. These ratings are based on ideal conditions, however in practice, working conditions may vary widely. All lifting applications should be assessed by a competent person in order to establish the size and type of sling required.

In the case of multi-leg slings, the angle between the legs is critical. The actual tension on each leg increases when the angle between the legs increases as shown in the diagram opposite. For this reason all general purpose chain slings are given a rating based upon use at 90° inc. angle. The included angle between the legs should never exceed 120°.

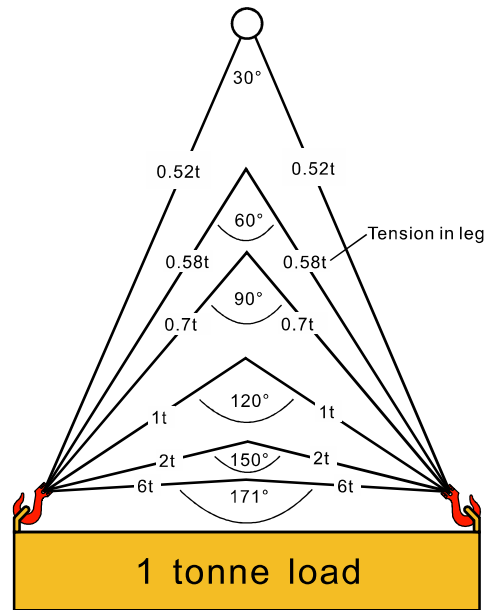

The distance between the crane hook and the load is known as the “Head Room”. If a specific head room is required, the “Reach” of the chain sling must increase as the angle between the legs increases as shown opposite.

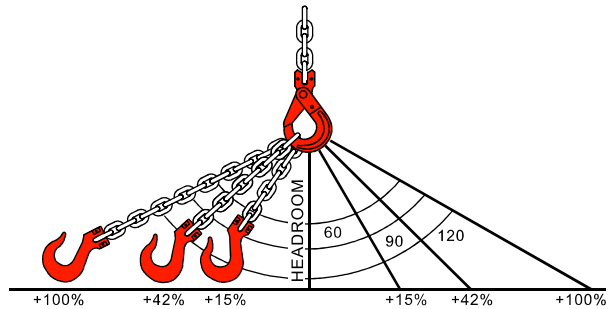

The reach of a chain sling is the distance between bearing points of the upper and lower terminal fittings. This distance, commonly known as the “Bearing to Bearing” should be quoted when ordering slings. Shortening clutches may be fitted to a sling, making the reach adjustable, hence increasing the versatility of the sling.

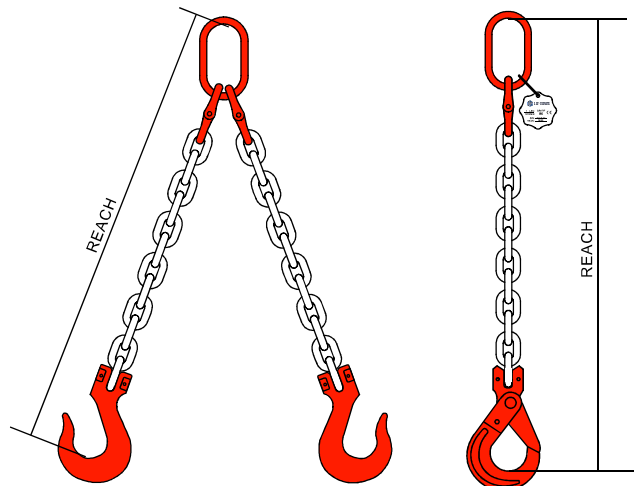

GRADE 80 CHAIN SLING

Unusual Applications

Recommended Load Factors for unusual slinging methods and conditions.
Factor normally applied to W.L.L. of a Single Chain.

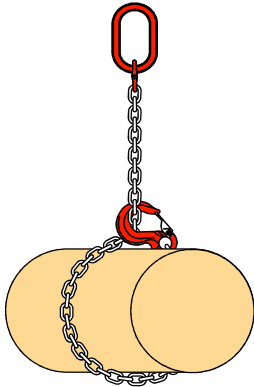

0,8



1,4

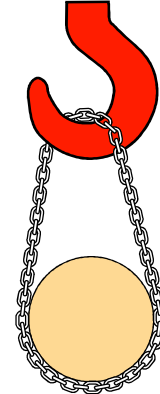

1,3

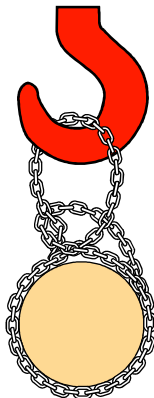

1,6

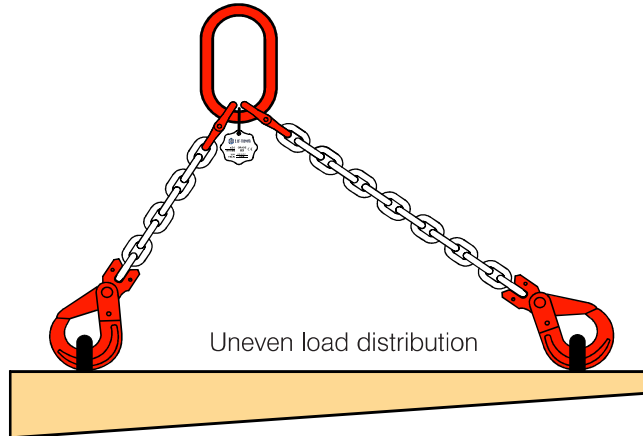

This factor is applicable to W.L.L. of a standard Double Branch Sling 0,7

Temperature loadings: Applicable to chain temperature

-40° to 200° C 1	200° C to 300° C 0,9	300° C to 400° C 0,75
---------------------	-------------------------	--------------------------

Edge loadings: Applicable to load lifting and load lashing

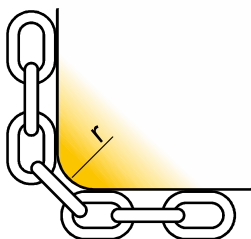

$r = \text{more than } 2 \times \text{chain size}$
1

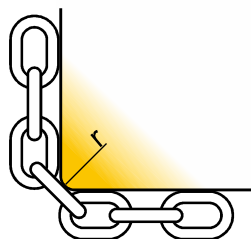

$r = \text{more than chain size}$
0,7

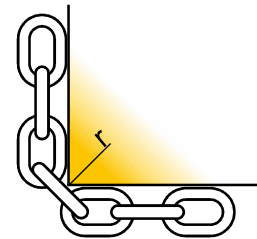

NOT RECOMMENDED
WITHOUT CORNER PROTECTION

GRADE 80 CHAIN SLING

WORKING LOAD LIMITS IN TONNES ACC. TO EN1677

For chain size mm	Ton	3 legs		4 legs		Choke endless sling
		β 0 - 45° α 0 - 90°	45° - 60° 90° - 120°	β 0 - 45° α 0 - 90°	45° - 60° 90° - 120°	
6	1.12	1.6	1.12	2.36	1.7	1.8
7	1.5	2.12	1.5	3.15	2.24	2.5
8	2.0	2.8	2.0	4.25	3.0	3.15
10	3.15	4.25	3.15	6.7	4.75	5.0
13	5.3	7.5	5.3	11.2	8.0	8.5
16	8.0	11.2	8.0	17.0	11.8	12.5
18	10.0	14.0	10.0	21.2	15.0	16.0
20	12.5	17.0	12.5	26.5	19.0	20.0
22	15.0	21.2	15.0	31.5	22.4	23.6
26	21.2	30.0	21.2	45.0	31.5	33.5
32	31.5	45.0	31.5	67.0	47.5	50.0

- Never exceed working load limit.
- Safety factor 4:1.
- The Alpha(α) angle should never exceed 120°; The Beta(β) angle should never exceed 60°.

CHAIN SLING TAG

Aluminum Tag With Ring



Aluminum Tag With Ring



GRADE 80 CHAIN SLING

1- AND 2-LEG CHAIN SLINGS

Clevis self-locking hooks or sling hooks as standard ends.
 Alternative ends are also available.
 The assemblies include a load plate.
 Powder coated
 Safety factor 4 : 1
 EN 818-4

Note! The leg length of the chain assembly, unless specifically ordered, is as presented in the image L1

NOTE: option:  NFC identification

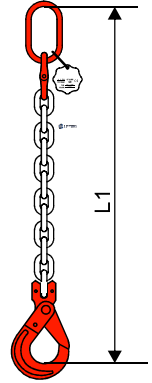

1-LEG



Chain Size mm	WLL ton				
6	1.12				
7	1.5				
8	2				
10	3.15				
13	5.3				
16	8				
18	10				
20	12.5				
22	15				
26	21.2				
32	31.5				

2 LEGS



Chain Size mm	WLL/ton					
	0-45° chain angle	45-60° chain angle				
6	1.6	1.12				
7	2.12	1.5				
8	2.8	2				
10	4.25	3.15				
13	7.5	5.3				
16	11.2	8				
18	14	10				
20	17	12.5				
22	21.2	15				
26	30	21.2				
32	45	31.5				

GRADE 80 CHAIN SLING

3- AND 4-LEG CHAIN SLINGS

Clevis self-locking hooks or sling hooks as standard ends.
 Alternative ends are also available.
 The assemblies include a load plate
 Powder coated
 Safety factor 4 : 1
 EN 818-4

Note! The leg length of the chain assembly, unless specifically ordered, is as presented in the image L1

NOTE: option:  NFC identification

3-LEGS



Chain Size	WLL/ton					
	0-45° chain angle	45-60° chain angle				
6	2.36	1.7				
7	3.15	2.24				
8	4.25t	3				
10	6.7	4.75				
13	11.2	8				
16	17	11.8				
18	21.2	15				
20	26.5	19				
22	31.5	22.4				
26	45	31.5				
32	67	47.5				

4-LEGS



Chain Size	WLL/ton					
	0-45° chain angle	45-60° chain angle				
6	2.36	1.7				
7	3.15	2.24				
8	4.25t	3				
10	6.7	4.75				
13	11.2	8				
16	17	11.8				
18	21.2	15				
20	26.5	19				
22	31.5	22.4				
26	45	31.5				
32	67	47.5				

GRADE 80 CHAIN

GRADE 80 CHAIN FOR CHAIN SLING (EN818-2)

Suitable for overhead lifting application. For use with Grade 80 components.
 High tensile alloy steel.
 Standard: EN818-2 Material: alloy steel
 Safety factor: 4:1 Proof load: 2.5 times the Working Load Limit

Item No.	Size mm	Pitch mm	Width		WLL T	Proof Force kN	Min. Breaking Load kN	Weight kg/m	Product Code
			Internal Min. mm	External Max. mm					
G8S0618	6	18	7.8	22.2	1.12	28.3	45.2	0.78	
G8S0721	7	21	9.1	25.9	1.5	38.5	61.6	1.06	
G8S0824	8	24	10.4	29.6	2	50.3	80.4	1.38	
G8S1030	10	30	13.0	37.0	3.15	78.5	126	2.2	
G8S1339	13	39	16.9	48.1	5.3	133	212	3.7	
G8S1648	16	48	20.8	59.2	8	201	322	5.6	
G8S1854	18	54	23.4	66.6	10	254	407	6.8	
G8S2060	20	60	26.0	74.0	12.5	314	503	8.6	
G8S2266	22	66	28.6	81.4	15	380	608	12	
G8S2678	26	78	33.8	96.2	21.2	531	849	14.87	
G8S3296	32	96	41.6	118.0	31.5	804	1290	22.29	

Surface finish: black e-coated, powder coated, black painted, or black oxidized.

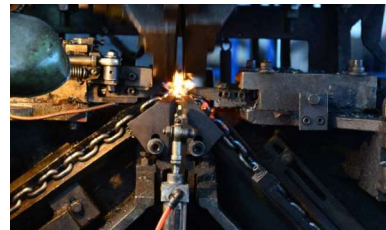
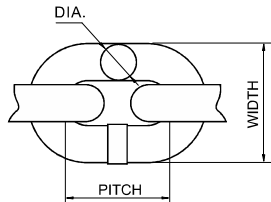

GRADE 80 LIFTING CHAIN

Manual Hoisting Equipments
 Electric Hoisting Equipments
 Textile Sling and Height Safety
 Transport and Load Restraints
 Lifting Chain/Chain Sling/Components
 Wire Rope/Wire Rope Sling/Components
 Forestry and Rigging Hardware
 Material Handling Equipments

INSPECTION:

1. Clean each chain sling prior to inspection, and daily check for visible faults in links or hooks, such as nicks, cracks or other damages.

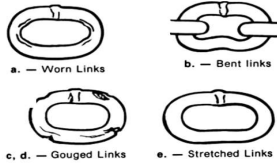

2. Check the sling tag legibility, and ensure that its serial number, manufacturer name, size, grade, working load limit and length correspond to the original chain sling certification.

3. Measure the lengths of sling legs to make sure that they correspond to the ones stamped on the chain sling tags.

If one or more legs are longer, there is a possibility that the sling has been subjected to overloading or excessive wear.

4. Inspect the master link, connecting links and hooks for wear or damage as following:

- (1) any wear exceeding 10% (or as recommended by the manufacturer) of the original section dimension of the hook or its load pin;
- (2) any visible apparent bend or twist from the plane of the unbent hook;
- (3) any distortion causing an increase in throat opening of 5% not to exceed 6mm, or as recommended by the manufacturer;
- (4) any self locking hook that does not lock;
- (5) thread wear, damage or corrosion

DO NOT:

1. **DO NOT** land the load directly onto the chain.

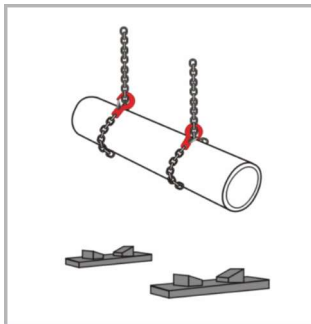

2. **DO NOT** attempt to repair chain slings yourself but refer such matters to a Competent Person.



3. **DO NOT** jerk the load when lifting or lowering the sling.

4. **DO NOT** knot or twist the chain.

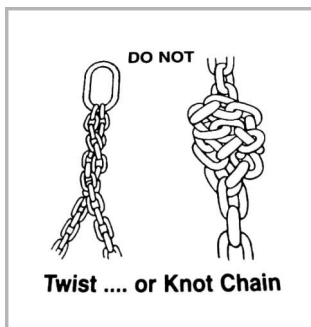

5. **DO NOT** wedge or force the hook point into the loads.

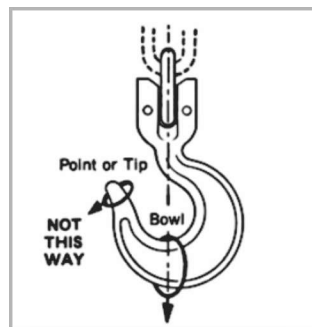

6. **DO NOT** splice the sling by inserting a bolt between two links.

7. **DO NOT** return damaged or contaminated chain slings to storage; **DO NOT** drag the slings and lie them on the ground.

GRADE 80 SLING COMPONENTS

- Master link: link forming the upper terminal of a sling by means of which the sling is attached to the hook of a crane or other lifting machine.
- Intermediate master link: link used to connect one or two legs of a sling to a master link.
- Master link assembly: assembly consisting of a master link together with two intermediate master links.
- Designed for use with steel wire rope or grade 80 alloy steel chain.
- For overhead lifting application.

GRADE 80 EUROPEAN TYPE WELDED MASTER LINK, MLU TYPE

Standard: EN1677
Material: alloy steel — quenched and tempered
Surface finish: powder coated
Proof load: 2.5 times the Working Load Limit
Safety factor: 4:1

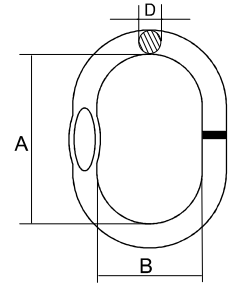

*Engineered flat for use with omega link.

Item No.	WLL	Main Dimensions(mm)			Weight	Product Code
	ton	A	B	D	kg	
8-MLU-0706	1.6	110	60	13	0.34	
8-MLU-0807	2.12	110	60	16	0.54	
8-MLU-1008	3.15	135	75	18	0.823	
8-MLU-1310	5.3	160	90	22	1.5	
8-MLU-1613	8	180	100	26	2.32	
8-MLU-1816	11.2	200	110	32	3.95	
8-MLU-2018	14	260	140	36	6.34	
8-MLU-2220	17	300	160	40	8.96	
8-MLU-2622	21.2	340	180	45	12.8	
8-MLU-3226	31.5	350	190	50	16.55	
8-MLU-3632	45	400	200	56	23.28	
8-MLU-4036	56	430	220	63	32	
8-MLU-0072	63	460	250	72	45.76	

* 8-MLU-2622 and above are forged.

GRADE 80 SLING COMPONENTS

GRADE 80 EUROPEAN TYPE WELDED MASTER LINK ASSEMBLY, MAU TYPE

Standard: EN1677
 Material: alloy steel — quenched and tempered
 Surface finish: powder coated
 Proof load: 2.5 times the Working Load Limit
 Safety factor: 4:1

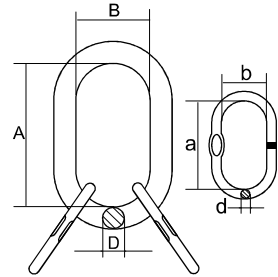

*Engineered flat for use with omega link.

Item No.	Chain Size	WLL	Main Dimensions(mm)						Weight	Product Code
	mm		ton	A	B	D	a	b		
8-MAU-06	6	2.36	135	75	18	54	25	13	1.18	
8-MAU-07	7	3.15	135	75	18	60	38	13	1.24	
8-MAU-08	8	4.25	160	90	22	70	34	16	2.2	
8-MAU-10	10	6.7	180	100	26	85	40	18	3.4	
8-MAU-13	13	11.2	200	110	32	115	50	22	6.1	
8-MAU-16	16	17	260	140	36	140	65	26	9.98	
8-MAU-18	18	21.2	340	180	45	180	100	32	18.9	
8-MAU-20	20	26.5	350	190	50	180	100	32	23.7	
8-MAU-22	22	31.5	350	190	50	180	100	36	25.2	
8-MAU-26	26	45	400	200	56	180	100	40	35.2	
8-MAU-28	28	50	430	220	63	180	100	45	47	
8-MAU-32	32	67	460	250	72	200	110	50	66.46	

* 8-MAU-06 ~ 8-MAU-18: main link welded; sub link welded.

* 8-MAU-20 and above: main link forged; sub link welded.

GRADE 80 MASTER LINK ASSEMBLY WITH LARGE SUB-LINKS, MAL TYPE

Standard: EN1677
 Material: alloy steel — quenched and tempered
 Surface finish: powder coated
 Proof load: 2.5 times the Working Load Limit
 Safety factor: 4:1

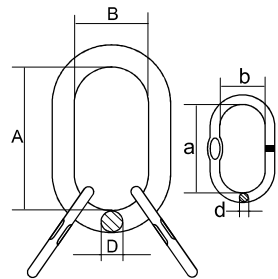
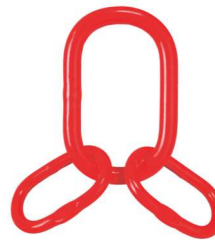

*Engineered flat for use with omega link.

Item No.	Chain Size	WLL	Main Dimensions(mm)						Weight	Product Code
	mm		ton	A	B	D	a	b		
8-MAL-07	7	3.15	160	95	20	110	60	13	1.9	
8-MAL-08	8	4.25	160	95	22	140	80	16	2.82	
8-MAL-10	10	6.7	190	110	26	160	95	20	4.87	
8-MAL-13	13	11.2	230	130	32	190	110	26	9.38	
8-MAL-16	16	17	275	150	38	230	130	30	15.25	
8-MAL-20	20	26.5	340	180	45	230	130	32	21.78	
8-MAL-22	22	31.5	350	190	50	275	150	38	31.52	
8-MAL-26	26	45	400	200	56	340	180	45	48.92	

Manual Hoisting
Equipment

Electric Hoisting
Equipment

Textile Sling and
Height Safety

Transport and
Load Restraints

Lifting Chain/Chain
Sling/Components

Wire Rope/Wire Rope
Sling/Components

Forestry and
Rigging Hardware

Material Handling
Equipment

GRADE 80 SLING COMPONENTS

GRADE 80 CONNECTING LINK, CNL TYPE

- Used to connect grade 80 chain to an oblong link, hook or other components.
- Quenched & tempered.
- 100% Magnaflux Crack Detection.

Standard: EN 1677
 Material: forged alloy steel
 Proof load: 2.5 times the Working Load Limit
 Safety factor: 4:1
 Surface finish: powder coated

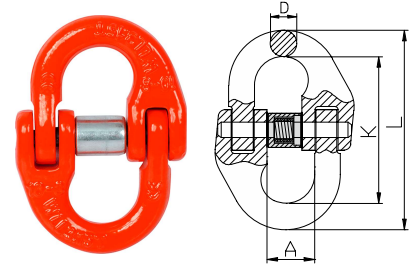

Item No.	Chain Size	WLL ton	Main Dimensions(mm)				Weight kg	Product Code
	mm		A	L	K	D		
8-CNL-06	6	1.12	15	58	42	7	0.08	
8-CNL-07	7	1.5	20	73	54.8	8.5	0.145	
8-CNL-08	7+8	2	20.5	79.5	60.5	8.5	0.146	
8-CNL-10	10	3.15	26	90.5	68	11.5	0.3	
8-CNL-13	13	5.3	30	117	87	15	0.65	
8-CNL-16	16	8	35	148	108.4	19.8	1.15	
8-CNL-18	18	10	38	154	112	21	1.84	
8-CNL-20	18+20	12.5	41	169.5	121.5	24	2.1	
8-CNL-22	22	15	49.5	193.5	141.5	26	2.87	
8-CNL-26	26	21.2	57.5	220	158	30	4.5	
8-CNL-32	32	31.5	67.5	281	205	37	8.21	

LOAD PIN AND SLEEVE OPTIONS



LOAD PIN AND DOUBLE SLEEVE

Item No.	Chain Size	Item No.	Chain Size
	mm		mm
8-SP-CNL-A-06	6	8-SP-CNL-A-18	18
8-SP-CNL-A-08	7+8	8-SP-CNL-A-20	18+20
8-SP-CNL-A-10	10	8-SP-CNL-A-22	22
8-SP-CNL-A-13	13	8-SP-CNL-A-26	26
8-SP-CNL-A-16	16	8-SP-CNL-A-32	32

LOAD PIN AND SINGLE SLEEVE

Item No.	Chain Size	Item No.	Chain Size
	mm		mm
8-SP-CNL-B-06	6	8-SP-CNL-B-18	18
8-SP-CNL-B-08	7+8	8-SP-CNL-B-20	18+20
8-SP-CNL-B-10	10	8-SP-CNL-B-22	22
8-SP-CNL-B-13	13	8-SP-CNL-B-26	26
8-SP-CNL-B-16	16	8-SP-CNL-B-32	32

*Surface finish of sleeve and load pin: black oxidized, zinc plated or chrome plated.
 *All load pins are individually inspected and tested.

GRADE 80 SLING COMPONENTS

GRADE 80 WEB SLING CONNECTOR, WSC TYPE

- Designed with an extra wide body to connect webbing sling or round sling to grade 80 chain components.
- Quenched & tempered.
- 100% Magnaflux Crack Detection.

Standard: EN 1677
Material: forged alloy steel
Proof load: 2.5 times the Working Load Limit
Safety factor: 4:1
Surface finish: powder coated

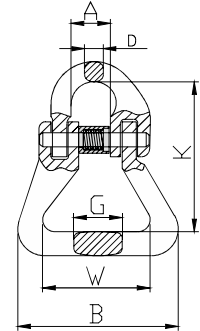

Item No.	Chain Size	WLL	Main Dimensions (mm)						Weight	Product Code
	mm		ton	A	B	K	W	G		
8-WSC-06	6	1.12	15	60	56	40	18	7	0.17	
8-WSC-08	7+8	2	20	61.5	64	40	24	8.5	0.3	
8-WSC-10	10	3.15	24	75	83	45	30.5	9	0.5	
8-WSC-13	13	5.3	28	88	93.7	54	36.8	16.5	1.03	
8-WSC-16	16	8	35	108	120	65.5	45.2	19.8	1.87	
8-WSC-20	20	12.5	41	129	138	80	51.8	23	2.97	
8-WSC-22	22	15	50	191	180	126	70	26	6.4	
8-WSC-26	26	21.2	58	228.4	209.5	152	86	30	10.25	
8-WSC-32	32	31.5	72.5	252	279	160	91	55	19	

GRADE 80 SWIVEL SELF LOCKING HOOK WITH BEARING, SSB TYPE

- SSB type hooks will not open when under load as the latch closes automatically.
- Hook rotates easily also with full load.
- Quenched & tempered.
- 100% Magnaflux Crack Detection.

Standard: EN 1677
Material: forged alloy steel
Proof load: 2.5 times the Working Load Limit
Safety factor: 4:1
Surface finish: powder coated

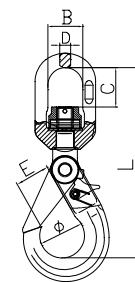

Item No.	Chain Size	WLL	Main Dimensions(mm)						Weight	Product Code
	mm		ton	B	C	D	L	Ø		
8-SSB-06	6	1.12	32.5	33.8	11.5	160	34	32	0.71	
8-SSB-08	7+8	2	36	40	13	202	44	40	1.1	
8-SSB-10	10	3.15	42	48	15.5	237	58	48	2.1	
8-SSB-13	13	5.3	50	58	17	282	70	57	4	
8-SSB-16	16	8	61	60	21.5	341.5	86	65	7.3	
8-SSB-20	20	12.5	76	75.5	26.5	399.5	97	82	11.6	
8-SSB-22	22	15	97	97	33	466	98	80	16	
8-SSB-26	26	21.2	123	115	42	544	110	109	21.5	

GRADE 80 SLING COMPONENTS

GRADE 80 EYE SELF LOCKING HOOK, ESK TYPE

- ESK type hooks will not open when under load as the latch closes automatically.
- Quenched & tempered.
- 100% Magnaflux Crack Detection.

Standard: EN 1677
 Material: forged alloy steel
 Proof load: 2.5 times the Working Load Limit
 Safety factor: 4:1
 Surface finish: powder coated

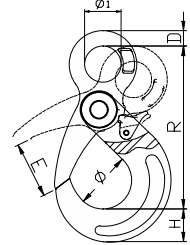

Item No.	Chain Size	WLL ton	Main Dimensions(mm)						Weight	Product Code
	mm		Ø1	R	D	Ö	H	E	kg	
8-ESK-06	6	1.12	21	110	11	34	20	32	0.5	
8-ESK-08	7+8	2	25	136	13	44	26	40	0.85	
8-ESK-10	10	3.15	34.5	168	15	58	30	48	1.42	
8-ESK-13	13	5.3	39.5	207	21	70	40	52	2.86	
8-ESK-16	16	8	50	254	27	86	50.5	65	5.9	
8-ESK-20	20	12.5	64.5	278	27	97	55	82	8.5	
8-ESK-22	22	15	70	319	32	98	67	80	11.6	
8-ESK-26	26	21.2	80	362	34	110	75	109	18	
8-ESK-32	32	31.5	105	470	45	164	97	131	46	

TRIGGER KITS FOR ESK, CSK, SSK AND SSB TYPE SELF LOCKING HOOK



Item No.	Chain Size	Item No.	Chain Size
	mm		mm
8-SP-SK-06	6	8-SP-SK-20	18+20
8-SP-SK-08	7+8	8-SP-SK-22	22
8-SP-SK-10	10	8-SP-SK-26	26
8-SP-SK-13	13	8-SP-SK-32	32
8-SP-SK-16	16	/	/

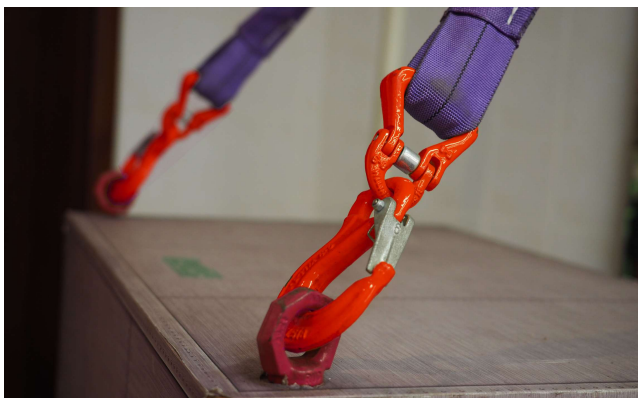

GRADE 80 SLING COMPONENTS

GRADE 80 CLEVIS SELF LOCKING HOOK, CSK TYPE

- CSK type hooks will not open when under load as the latch closes automatically.
- Quenched & tempered.
- 100% Magnaflux Crack Detection.

Standard: EN 1677
Material: forged alloy steel
Proof load: 2.5 times the Working Load Limit
Safety factor: 4:1
Surface finish: powder coated

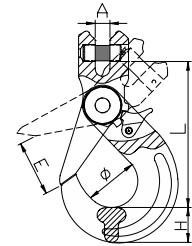

Item No.	Chain Size	WLL ton	Main Dimensions(mm)					Weight	Product Code
	mm		E	A	H	Ö	L	kg	
8-CSK-06	6	1.12	32	8	20	34	99	0.44	
8-CSK-08	7+8	2	40	9.5	26	44	119	0.8	
8-CSK-10	10	3.15	48	12.5	30	58	142	1.38	
8-CSK-13	13	5.3	57	15	40	70	179	2.81	
8-CSK-16	16	8	65	18.5	50.5	86	225	6	
8-CSK-20	20	12.5	80	24	55	97	238	7.25	
8-CSK-22	22	15	83	25	67	98	277	12.8	
8-CSK-26	26	21.2	109	30	75	110	312	21.8	
8-CSK-32	32	31.5	131	35	97	164	416	49.6	

LOAD PINS FOR CLEVIS SELF LOCKING HOOK

Item No.	Chain Size	Item No.	Chain Size
	mm		mm
8-SP-CSK-06	6	8-SP-CSK-20	18+20
8-SP-CSK-08	7+8	8-SP-CSK-22	22
8-SP-CSK-10	10	8-SP-CSK-26	26
8-SP-CSK-13	13	8-SP-CSK-32	32
8-SP-CSK-16	16	/	/



GRADE 80 SLING COMPONENTS

GRADE 80 CLEVIS SLING HOOK WITH LATCH, CSH TYPE

- Lifting chain is attached directly to the hook without a connecting link.
- Quenched & tempered.
- 100% Magnaflux Crack Detection.

Standard: EN 1677
 Material: forged alloy steel
 Proof load: 2.5 times the Working Load Limit
 Safety factor: 4:1
 Surface finish: powder coated

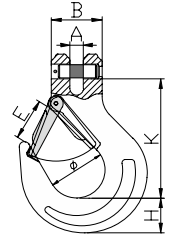

Item No.	Chain Size	WLL ton	Main Dimensions(mm)						Weight	Product Code
	mm		A	B	Ö	H	K	E	kg	
8-CSH-06	6	1.12	8	32	35	23	76	26	0.32	
8-CSH-08	7+8	2	9.5	37	37	25	86.4	29	0.48	
8-CSH-10	10	3.15	12.5	49	46	31	104	39	0.95	
8-CSH-13	13	5.3	16.5	56.5	56	42.5	128	47.5	1.8	
8-CSH-16	16	8	21.5	70.5	60	54	150	56	3.4	
8-CSH-20	20	12.5	24	77	79	58	180	59	6	
8-CSH-22	22	15	26	91	101	62	213	72	10.4	
8-CSH-26	26	21.2	30	117	115	75	250	101	14.5	
8-CSH-32	32	31.5	35	150	140	88	317	124	27	

LATCH KITS FOR CLEVIS SLING HOOK



Item No.	Chain Size	Item No.	Chain Size
	mm		mm
8-SP-CSH-06	6	8-SP-CSH-20	18+20
8-SP-CSH-08	7+8	8-SP-CSH-22	22
8-SP-CSH-10	10	8-SP-CSH-26	26
8-SP-CSH-13	13	8-SP-CSH-32	32
8-SP-CSH-16	16	/	/

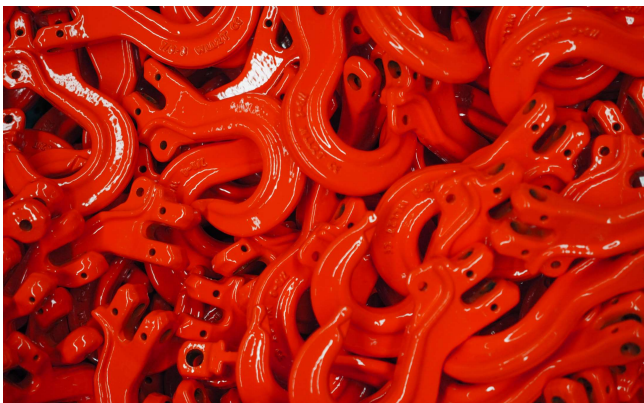

GRADE 80 SLING COMPONENTS

GRADE 80 EYE SLING HOOK WITH SAFETY LATCH, ESH TYPE

- Comes with spring-loaded safety latch.
- Quenched & tempered.
- 100% Magnaflux Crack Detection.

Standard: EN 1677
 Material: forged alloy steel
 Proof load: 2.5 times the Working Load Limit
 Safety factor: 4:1
 Surface finish: powder coated

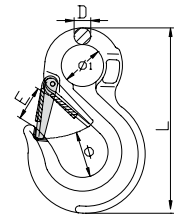

Item No.	Chain Size	WLL ton	Main Dimensions(mm)					Weight	Product Code
	mm		D	E	Φ	Φ1	L	kg	
8-ESH-06	6	1.12	9	21.5	20	20	108	0.3	
8-ESH-08	7+8	2	11	27.5	24	25	133	0.4	
8-ESH-10	10	3.15	15	27.2	38	38	167	0.9	
8-ESH-13	13	5.3	19	38.5	51	43	213	2.2	
8-ESH-16	16	8	23	42	62	50	255	3.2	
8-ESH-20	20	12.5	24	44.6	74.8	63	305	5.8	
8-ESH-22	22	15	32	70	68	62	348	9.2	
8-ESH-26	26	21.2	35	84	84	64	394	13	
8-ESH-32	32	31.5	37	102	100	88	480	18.5	

LATCH KITS FOR EYE SLING HOOK



Item No.	Chain Size	Item No.	Chain Size
	mm		mm
8-SP-ESH-06	6	8-SP-ESH-20	18+20
8-SP-ESH-08	7+8	8-SP-ESH-22	22
8-SP-ESH-10	10	8-SP-ESH-26	26
8-SP-ESH-13	13	8-SP-ESH-32	32
8-SP-ESH-16	16	/	/

GRADE 80 SLING COMPONENTS

GRADE 80 EYE CRADLE GRAB HOOK, EGK TYPE

- Used for shortening chain legs.
- Hook to be attached to the master link with the same connecting link as the chain.
- No reduction of working load limit due to supporting cradle in saddle of hook.
- Quenched & tempered.
- 100% Magnaflux Crack Detection.

Standard: EN 1677
 Material: forged alloy steel
 Proof load: 2.5 times the Working Load Limit
 Safety factor: 4:1
 Surface finish: powder coated

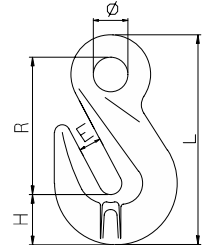

Item No.	Chain Size	WLL ton	Main Dimensions(mm)					Weight	Product Code
	mm		E	Ö	H	R	L	kg	
8-EGK-06	6	1.12	8	13.5	17.9	51.4	75.3	0.14	
8-EGK-08	7+8	2	10.8	18	20	61.5	91.2	0.245	
8-EGK-10	10	3.15	13	20	29	80	122	0.65	
8-EGK-13	13	5.3	16.5	26	42.8	99.7	158	1.39	
8-EGK-16	16	8	20	30.5	47.7	104	169	2.2	
8-EGK-20	20	12.5	25	37.5	56	140	219	4.6	
8-EGK-22	22	15	28	44	68	165	259	8.2	
8-EGK-26	26	21.2	30	44	77	188.8	298	9.8	
8-EGK-32	32	31.5	38	57	95	228	361	19.4	

GRADE 80 SWIVEL HOOK, SWH TYPE

- Hook can be rotated to the desired position prior to lifting load.
- Quenched & tempered.
- 100% Magnaflux Crack Detection.

Standard: EN 1677
 Material: forged alloy steel
 Proof load: 2.5 times the Working Load Limit
 Safety factor: 4:1
 Surface finish: powder coated

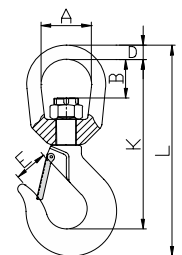

Item No.	Chain Size	WLL ton	Main Dimensions(mm)						Weight	Product Code
	mm		A	E	B	D	K	L	kg	
8-SWH-06	6	1.12	32	17	22.5	9	109	137	0.34	
8-SWH-08	7+8	2	42	21.5	35	15.8	150	192	1.02	
8-SWH-10	10	3.15	42.5	26	35	15.8	162.5	208.5	1.24	
8-SWH-13	13	5.3	48	32.5	39	18	191	246	2.33	
8-SWH-16	16	8	62	43	53	25	243.5	313	4.66	
8-SWH-20	20	12.5	68	49.5	51	28.5	276.5	363.5	7.4	
8-SWH-22	22	15	79	54.5	65	32	332	431	10.6	
8-SWH-26	26	21.2	105	81	114	40	429.5	545.5	21.4	
8-SWH-32	32	31.5	105	100	96	40	465.3	596	32	

GRADE 80 SLING COMPONENTS

GRADE 80 EYE CHOKE HOOK, ECK TYPE

- Used with OML type omega link to form choker with chain.
- Quenched & tempered.
- 100% Magnaflux Crack Detection.

Standard: EN 1677
 Material: forged alloy steel
 Proof load: 2.5 times the Working Load Limit
 Safety factor: 4:1
 Surface finish: powder coated

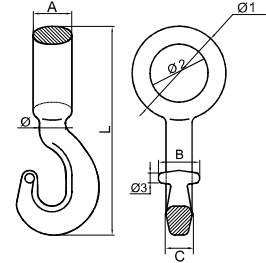
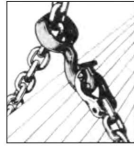

Item No.	Chain Size	WLL ton	Main Dimensions (mm)								Weight kg	Product Code
	mm		A	B	C	φ	φ1	φ2	φ3	L		
8-ECK-08	7+8	2	19	28	16.5	17	52	30.5	7.5	123	0.36	
8-ECK-10	10	3.2	26	40	17.5	20	68	39	8	157	0.72	
8-ECK-13	13	5.4	34	43	21	25	87	53	10	196.5	1.4	
8-ECK-16	16	8.2	51	45.5	31	30	108	64	10.5	246	3.17	
8-ECK-18	18	10	49.5	53	33.5	33.5	121	75	12	268.6	3.8	
8-ECK-20	20	12.6	70	80	44	52	146	84	14	367	8.95	
8-ECK-26	26	21.2	80	80	44	60	180	100	24.3	417	16.65	

GRADE 80 CLEVIS C HOOK, CCK TYPE

- The hook tip is shaped to prevent accidental unhooking when not under load.
- Lifting chain is attached directly to the hook without a connecting link.
- Only for applications without safety catch requirement.
- Quenched & tempered.
- 100% Magnaflux Crack Detection.

Standard: EN 1677
 Material: forged alloy steel
 Proof load: 2.5 times the Working Load Limit
 Safety factor: 4:1
 Surface finish: powder coated

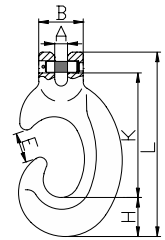

Item No.	Chain Size	WLL ton	Main Dimensions (mm)						Weight kg	Product Code
	mm		A	E	B	H	K	L		
8-CCK-08	7+8	2	9.5	20	35	28	90	136	0.57	
8-CCK-10	10	3.15	13	29.5	46	39.5	127	189	1.4	
8-CCK-13	13	5.3	16.5	39.5	59	52	166.5	246	3	
8-CCK-16	16	8	18.5	46.5	72	59	206	298	5.42	

GRADE 80 SLING COMPONENTS

GRADE 80 CONTAINER HOOK, CTK TYPE

- Large eye allows for easy connection to most hooks.
- Left and right hand configurations as well as a straight configuration are available.
- Quenched & tempered.
- 100% Magnaflux Crack Detection.

Standard: EN 1677
 Material: forged alloy steel
 Proof load: 2.5 times the Working Load Limit
 Safety factor: 4:1
 Surface finish: powder coated

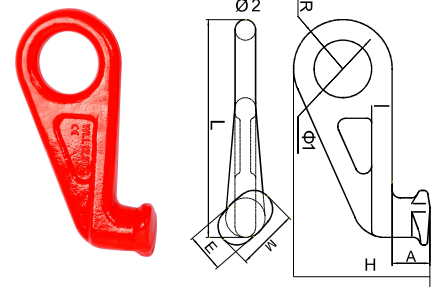

Item No.	WLL	Main Dimensions (mm)								Weight	Product Code
	ton	A	M	H	E	R	Φ1	Φ2	L	kg	
8-CTK-S	125	46	75	166	46	60	70	25	265	4 125	
8 CTK L	125	46	75	166	46	60	70	25	265	4.125	
8-CTK-R	125	46	75	166	46	60	70	25	265	4 125	

GRADE 80 EYE FOUNDRY HOOK, EFK TYPE

- Special purpose hook with large mouth opening.
- Suitable for lifting pipes and foundry use.
- Quenched & tempered.
- 100% Magnaflux Crack Detection.

Standard: EN 1677
 Material: forged alloy steel
 Proof load: 2.5 times the Working Load Limit
 Safety factor: 4:1
 Surface finish: powder coated

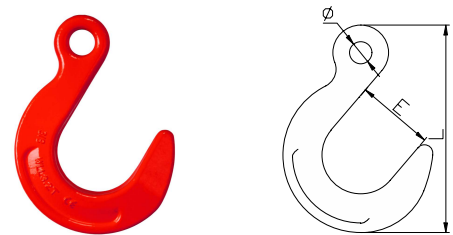

Item No.	Chain Size	WLL	Main Dimensions(mm)			Weight	Product Code
	inch	lbs	E	Ö	L	kg	
8-EFK-07	9/32(1/4)	3500	63.5	18	163	1.09	
8-EFK-10	3/8	7100	76	22	200	2.03	
8-EFK-13	1/2	12000	89	27	238	3.22	
8-EFK-16	5/8	18100	102	32	278	5.26	
8-EFK-20	3/4	28300	114.5	38	325	9.1	
8-EFK-22	7/8	34200	127.5	45	361	11.3	
8-EFK-26	1	48500	140	66.5	402	16.8	
8-EFK-32	1-1/4	72750	153.5	81.5	461	26.6	

GRADE 80 SLING COMPONENTS

GRADE 80 SWIVEL LIFTING POINT, SLP TYPE

- Compact and light-weight design with metric threads.
- Rotates through 360° and pivots 90°.
- Quenched & tempered.
- 100% Magnaflux Crack Detection.

Standard: EN 1677
 Material: forged alloy steel
 Proof load: 2.5 times the Working Load Limit
 Safety factor: 4:1
 Surface finish: powder coated

NOTE: option:  NFC identification

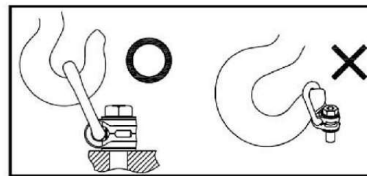
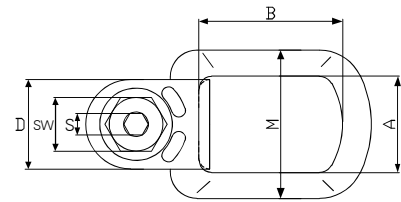
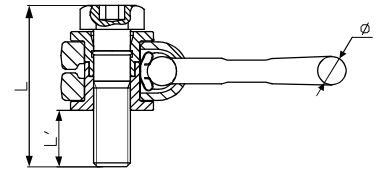

Figure 1

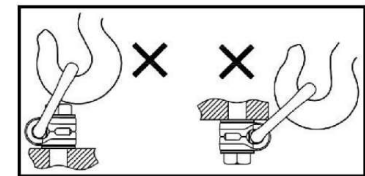

Figure 2

Item No.	Size	WLL ton	Main Dimensions(mm)									Weight kg	Product Code
	mm		A	B	D	S	SW	M	L	L*	Φ		
8-SLP-08010	M8	0.3	35	52.5	30	6	13	45	46	10.4	14	0.36	
8-SLP-10016	M10	0.63	35	52.5	30	6	17	45	52	16	14	0.38	
8-SLP-12018	M12	1	40	54	36	8	19	68	62	18	18	0.71	
8-SLP-14021	M14	1.2	40	54	36	8	19	68	66	21	18	0.72	
8-SLP-16024	M16	1.5	40	54	36	8	19	68	70	24	18	0.74	
8-SLP-18026	M18 X 26	2	54	80	50	12	30	83	83	26	16	1.16	
8-SLP-20030	M20	2.5	54	80	50	12	30	83	88	30	16	1.19	
8-SLP-20055	M20 X55	2.5	54	80	50	12	30	83	113	55	16	1.21	
8-SLP-20060	M20 X60	2.5	54	80	50	12	30	83	118	60	16	1.25	
8-SLP-24035	M24 X35	4	54	94	50	14	36	83	95	35	18	1.35	
8-SLP-24040	M24 X40	4	54	94	50	14	36	83	100	40	18	1.38	
8-SLP-24060	M24 X60	4	54	94	50	14	36	83	120	60	18	1.46	
8-SLP-27038	M27	4	73	106	68	17	41	120	120	38	27	4.18	
8-SLP-30048	M30	5	73	106	68	17	41	120	132	48	27	4.2	
8-SLP-30070	M30 X 70	5	73	106	68	17	41	120	154	70	27	4.4	
8-SLP-36054	M36 X 54	7	73	106	68	22	41	120	142	54	27	4.65	
8-SLP-36070	M36 X 70	7	73	106	68	22	55	120	158	70	27	4.8	
8-SLP-36062A	M36 X 62	8	94	140.5	86	22	55	156	163	62	31	7.6	
8-SLP-42072	M42	10	94	140.5	86	24	65	156	176	72	31	8.2	
8-SLP-42063A	M42 X 63	15	104	155	95	24	65	176	179	63	40	12.4	
8-SLP-48074	M48 X 74	20	104	155	95	27	75	176	194	74	40	13	

Manual Hoisting
Equipments

Electric Hoisting
Equipments

Textile Sling and
Height Safety

Transport and
Load Restraints

Lifting Chain/Chain
Sling/Components

Wire Rope/Wire Rope
Sling/Components

Forestry and
Rigging Hardware

Material Handling
Equipments

GRADE 80 SLING COMPONENTS

GRADE 80 LIFTING SWIVEL, LTS TYPE

- Compact and light-weight design with metric threads.
- The swivel must only be fitted on the assembly for the use of lifting.
- The swivel can also be used as lashing point for the fixture of lashing.
- Allow for 360° rotation and the lifting eye can turn to the direction of the load up to 180°.
- Quenched & tempered.
- 100% Magnaflux Crack Detection.

Standard: EN 1677
 Material: forged alloy steel
 Proof load: 2.5 times the Working Load Limit
 Safety factor: 4:1
 Surface finish: powder coated

NOTE: option:  NFC identification

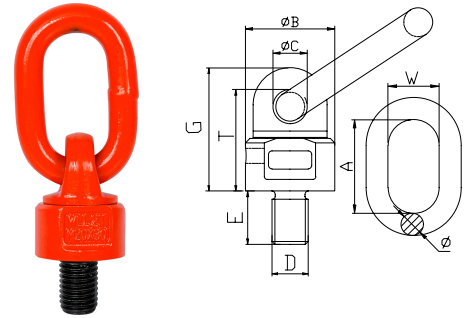

Item No.	Size	WLL/T(4:1)		Main Dimensions(mm)								Weight	Product Code
	mm	WLL 90°	WLL 0°	DxE	ΦB	ΦC	G	T	A	W	Φ	kg	
8-LTS-08013	M8	0.3	0.6	M8X13	36	16.5	52	41	55	30	14	0.45	
8-LTS-10018	M10	0.5	1	M10X18	36	16.5	52	41	55	30	14	0.45	
8-LTS-12018	M12	0.5	1	M12X18	36	16.5	52	41	55	30	14	0.46	
8-LTS-12045	M12X45	0.5	1	M12X45	36	16.5	52	41	55	30	14	0.48	
8-LTS-12110	M12X110	0.5	1	M12X110	36	16.5	52	41	55	30	14	0.54	
8-LTS-14020	M14	1.12	2.24	M14X20	36	16.5	52	41	55	30	14	0.49	
8-LTS-16020	M16	1.12	2.24	M16X20	36	16.5	52	42	55	30	14	0.47	
8-LTS-16120	M16X120	1.12	2.24	M16X120	36	16.5	52	42	55	30	14	0.63	
8-LTS-18030	M18	2	4	M18X30	49.5	19	69	56	70	35	16	0.95	
8-LTS-20030	M20	2	4	M20X30	49.5	19	69	56	70	35	16	0.99	
8-LTS-20040	M20X40	2	4	M20X40	49.5	19	69	56	70	35	16	1.02	
8-LTS-20120	M20X120	2	4	M20X120	49.5	19	69	56	70	35	16	1.21	
8-LTS-24030	M24	3.15	6.3	M24X30	57	22	78	65.5	85	40	18	1.33	
8-LTS-24090	M24X90	3.15	6.3	M24X90	57	22	78	65.5	85	40	18	1.54	
8-LTS-24120	M24X120	3.15	6.3	M24X120	57	22	78	65.5	85	40	18	1.65	
8-LTS-27035	M27	3.15	6.3	M27X35	57	22	78	65.5	85	40	20	1.47	
8-LTS-30035	M30(5T)	5.3	10.6	M30X35	66	23.5	96.5	80.5	85	40	20	2.3	
8-LTS-30045	M30X45	5.3	10.6	M30X45	66	23.5	96.5	80.5	85	40	20	2.35	
8-LTS-30120	M30X120	5.3	10.6	M30X120	66	23.5	96.5	80.5	85	40	20	2.77	
8-LTS-30035A	M30(8T)	8	12.8	M30X35	80	28	112	92	115	50	22	3.73	
8-LTS-30038A	M30X38	8	12.8	M30X38	80	28	112	92	115	50	22	3.79	
8-LTS-30120A	M30X120	8	12.8	M30X120	80	28	112	92	115	50	22	4.21	
8-LTS-36050	M36	8	12.8	M36X50	80	27	109	89.5	115	50	22	3.88	
8-LTS-36090	M36X90	8	12.8	M36X90	80	27	109	89.5	115	50	22	4.19	
8-LTS-36128	M36X128	8	12.8	M36X128	80	27	109	89.5	115	50	22	4.5	
8-LTS-36400	M36X400	8	12.8	M36X400	80	27	109	89.5	115	50	22	6.67	
8-LTS-39050	M39	8	12.8	M39X50	80	27	109	89.5	115	50	22	3.95	
8-LTS-39090	M39X90	8	12.8	M39X90	80	27	109	89.5	115	50	22	3.71	
8-LTS-42050	M42	10	16	M42X50	80	27	109	89.5	115	50	25	4.46	
8-LTS-48050	M48	10	16	M48X50	80	27	109	89.5	115	50	25	4.62	
8-LTS-56084	M56	15	24	M56X84	117	42	246	214	152	70	32	11.8	
8-LTS-64095	M64	15	24	M64X95	117	42	257	225	152	70	32	12.5	

GRADE 80 SLING COMPONENTS

GRADE 80 EYE BOLT WITH KEY, EBK TYPE

- Rotates through 360° adjustable in the direction of the load.
- Can be fixed in position by the key.
- Quenched & tempered.
- 100% Magnaflux Crack Detection.

Standard: EN 1677
 Material: forged alloy steel
 Proof load: 2.5 times the Working Load Limit
 Safety factor: 4:1
 Surface finish: powder coated

NOTE: option:  NFC identification

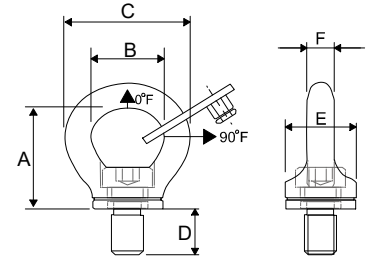

Item No.	Size	WLL/T		Main Dimensions(mm)						Weight	Product Code
	mm	WLL 0°	WLL 90°	A	B	C	D	E	F	kg	
8-EBK-08	M8	0.8	0.3	38	26	45.3	11.5	25	8	0.11	
8-EBK-10	M10	1	0.4	38	26	45.3	14	25	8	0.12	
8-EBK-12	M12	2	0.75	43.5	32	54	17	33	10	0.2	
8-EBK-16	M16	4	1.5	52	37.5	63.5	24	36	14	0.35	
8-EBK-20	M20	6	2.3	63	44.5	78.5	30	47.5	20.6	0.66	
8-EBK-24	M24	8	3.2	74	51.6	92	35.3	53	20	1.1	
8-EBK-30	M30	12	4.5	92	65	118	45	68	24	2.07	
8-EBK-36	M36	16	7	105	76	136	56.8	82	30	4	

GRADE 80 SLING COMPONENTS

- Sizes are based on DIN 580 eye bolt and DIN 582 eye nut.
- WLL for vertical lifting is marked on the eye.
- Quenched & tempered.
- 100% Magnaflux Crack Detection.

Standard: EN 1677
 Material: forged alloy steel
 Proof load: 2.5 times the Working Load Limit
 Safety factor: 4:1
 Surface finish: powder coated

NOTE: option:  NFC identification

GRADE 80 EYE BOLT, EBL TYPE

Item No.	Size	WLL/T		Main Dimensions(mm)				Weight	Product Code
	mm	WLL 0°	WLL 90°	D	K	Φ	L	kg	
8-EBL-06	M6	0.4	0.15	28	13	16	42	0.05	
8-EBL-08	M8	0.8	0.4	36	15	20	51	0.06	
8-EBL-10	M10	1	0.4	45	18	25	63	0.11	
8-EBL-12	M12	2	0.75	54	22	30	75	0.18	
8-EBL-14	M14	3	1	63	28	35	89.5	0.28	
8-EBL-16	M16	4	1.5	63	28	35	90	0.28	
8-EBL-18	M18	5	2	72	30	40	101	0.42	
8-EBL-20	M20	6	2.3	72	30	40	101	0.45	
8-EBL-22	M22	7	2.8	81	35	45	115.5	0.67	
8-EBL-24	M24	8	3.2	90	38	50	128	0.87	
8-EBL-27	M27	10	4	90	38	50	128	0.87	
8-EBL-30	M30	12	4.5	108	45	60	154	1.66	
8-EBL-33	M33	14	5	108	45	60	154	1.72	
8-EBL-36	M36	16	7	126	55	70	183	2.65	
8-EBL-39	M39	20	8	126	55	70	183	2.8	
8-EBL-42	M42	24	9	144	65	80	212	4.03	
8-EBL-45	M45	28	10	144	65	80	212	4.25	
8-EBL-48	M48	32	12	166	70	90	238	6.38	
8-EBL-52	M52	36	13.5	166	70	90	238	6.6	
8-EBL-56	M56	40	15	184	80	100	267	8.8	
8-EBL-64	M64	50	17	206	90	110	293	12.4	

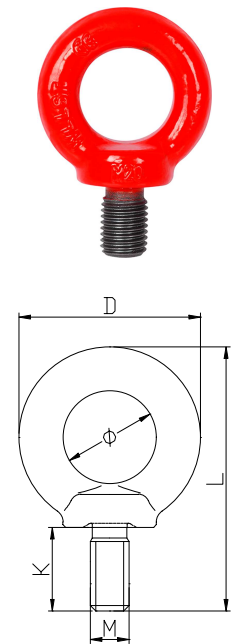

GRADE 80 EYE NUT, ENT TYPE

Item No.	Size	WLL/T(4:1)		Main Dimensions(mm)			Weight	Product Code
	mm	WLL 0°	WLL 90°	D	Φ	L	kg	
8-ENT-06	M6	0.4	0.15	36	20	36	0.05	
8-ENT-08	M8	0.8	0.4	36	20	36	0.05	
8-ENT-10	M10	1	0.4	45	25	45	0.09	
8-ENT-12	M12	2	0.75	54	30	53	0.16	
8-ENT-14	M14	3	1	63	35	62	0.24	
8-ENT-16	M16	4	1.5	63	35	62	0.24	
8-ENT-18	M18	5	2	72	40	71	0.34	
8-ENT-20	M20	6	2.3	72	40	71	0.36	
8-ENT-22	M22	7	2.8	81	45	81	0.58	
8-ENT-24	M24	8	3.2	90	50	90	0.72	
8-ENT-27	M27	10	4	90	50	90	0.72	
8-ENT-30	M30	12	4.5	108	60	109	1.32	
8-ENT-33	M33	14	5	108	60	109	1.29	
8-ENT-36	M36	16	7	126	70	128	2.09	
8-ENT-39	M39	20	8	126	70	128	2.09	
8-ENT-42	M42	24	9	144	80	147	3.11	
8-ENT-45	M45	28	10	144	80	147	3.05	
8-ENT-48	M48	32	12	166	90	168	5.02	
8-ENT-52	M52	36	13.5	166	90	168	4.94	
8-ENT-56	M56	40	15	184	100	187	6.69	
8-ENT-64	M64	50	17	206	110	208	9.3	

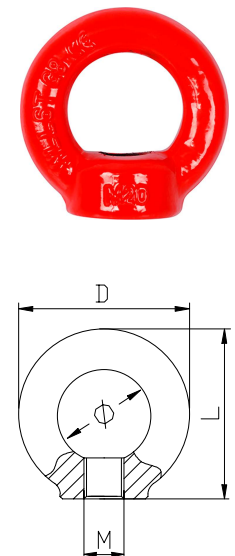

GRADE 80 SLING COMPONENTS

GRADE 80 D RING WITH SPRING, DRS TYPE

- Welded on plain surfaces as a lifting point, or to be used as a fixed anchor point for spreader beam attachment.
- Can also be used as an anchor point for load restraint applications.
- DRS type is equipped with a spring which enables the D ring to stay in the desired position.
- Quenched & tempered.
- 100% Magnaflux Crack Detection.

Standard: EN 1677
Material: forged alloy steel
Proof load: 2.5 times the Working Load Limit
Safety factor: 4:1
Surface finish: powder coated



Item No.	WLL	Main Dimensions(mm)				Weight	Product Code
	ton	A	B	D	M	kg	
8-DRS-1	1.12	41	78.5	13	38	0.47	
8-DRS-2	2	42	88	14	40	0.51	
8-DRS-3	3.15	46	94	17	43	0.69	
8-DRS-5	5.3	55	118	22	61	1.46	
8-DRS-8	8	70	141	26.5	70.5	2.52	
8-DRS-10	10	85	165	28	76	3.59	
8-DRS-15	15	97	188	34	90	5.79	

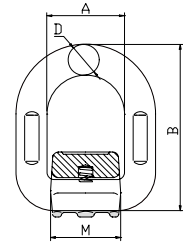

GRADE 80 SLING COMPONENTS

GRADE 80 WELD ON HOOK, WOH TYPE

- Designed to be a permanent sling attachment point for jibs and arms on mobile excavators.
- Quenched & tempered.
- 100% Magnaflux Crack Detection.

Standard: EN 1677
Material: forged alloy steel
Proof load: 2.5 times the Working Load Limit
Safety factor: 5:1
Surface finish: powder coated

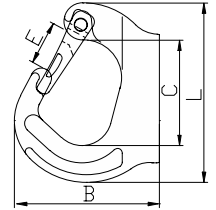
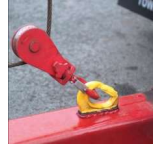

Item No.	WLL	Main Dimensions(mm)				Weight	Product Code
	ton	B	C	E	L	kg	
8-WOH-01	1	77.6	61.3	25	101.6	0.49	
8-WOH-02	2	92	67	28	114	0.87	
8-WOH-03	3	106	73.5	30	129	1.13	
8-WOH-05	5	133	94	39	171	2.5	
8-WOH-08	8	137	94	36	177	3.26	
8-WOH-10	10	170	135	48	223	5.2	

GRADE 80 SLING COMPONENTS

- Designed for lifting pre-cast concrete products like panels, pipes, columns, etc.
- LTR type lifting clutch with locking bolt is designed for safety and fast connection / removal.
- Quenched & tempered.
- 100% Magnaflux Crack Detection.

Standard: EN 1677
Material: forged alloy steel
Proof load: 2.5 times the Working Load Limit
Safety factor: 4:1 for LTC type;
 5:1 for LTR type
Surface finish: powder coated or zinc plated

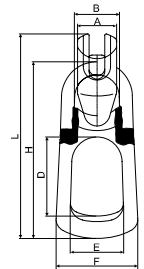

GRADE 80 LIFTING CLUTCH, LTC TYPE

Item No.	WLL	Main Dimensions(mm)							Weight	Product Code
	ton	A	B	D	E	F	H	L	kg	
8-LTC-013	1-1.3	33	42	70.5	45	73	160	186	0.89	
8-LTC-025	1.5-2.5	41	49	85	57	88	188	227	1.3	
8-LTC-050	3-5	55	70	88	69	110	242	282	3.24	
8-LTC-100	6-10	73	92	116	83	161	342	391	10.01	
8-LTC-200	12-20	110	114.5	133.5	107.5	182	437	497	20.37	

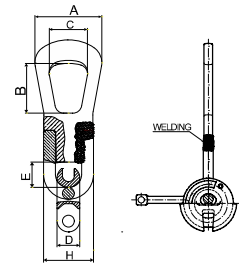

GRADE 80 LIFTING CLUTCH, LTR TYPE

Item No.	WLL	BL	Main Dimensions(mm)						Weight	Product Code
	ton	ton	A	B	C	D	H	E	kg	
8-LTR-025	2.5	12.5	95	70	58.8	27	58	35	1.58	
8-LTR-050	5	25	117	85	66.2	37	82	45	3.58	
8-LTR-100	10	50	148	110	84.6	50	110	56	9	



GRADE 100 LIFTING CHAIN

WORKING LOAD LIMITS IN TONNES ACC. TO EN1677

For chain size mm	Ton	Diagram 1: 90°		Diagram 2: 3 legs		Choke endless sling
		β 0 - 45° α 0 - 90°	45° - 60° 90° - 120°	β 0 - 45° α 0 - 90°	45° - 60° 90° - 120°	
6	1.4	2	1.4	3	2.12	2.24
7	1.9	2.65	1.9	4	2.8	3
8	2.5	3.55	2.5	5.3	3.75	4
10	4	5.6	4	8.4	6	6.3
13	6.7	9.5	6.7	14	10	10.6
16	10	14	10	21.2	15	16
18	12.5	17.5	12.5	26.3	18.8	20
19	14	20	14	30	21	22.4
20	16	22.4	16	33.6	24	25.6
22	19	26.5	19	40	28	30
26	26.5	37.5	26.5	56	40	42.4
32	40	56	40	85	60	64

- Never exceed working load limit.
- Safety factor 4:1.
- The Alpha(α) angle should never exceed 120°; The Beta(β) angle should never exceed 60°.

CHAIN SLING TAG

Aluminum Tag With Ring

Aluminum Tag With Ring



FRONT

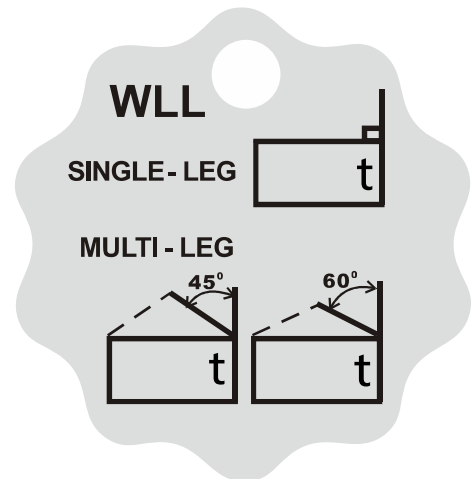

BACK

GRADE 100 CHAIN SLING

1- AND 2-LEG CHAIN SLINGS

Clevis self-locking hooks or sling hooks as standard ends.
 Alternative ends are also available.
 The assemblies include a load plate.
 Powder coated
 Safety factor 4 : 1

Note! The leg length of the chain assembly, unless specifically ordered, is as presented in the image L1

NOTE: option:  NFC identification

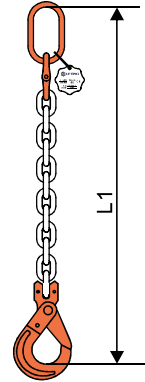

1 -LEG



Chain Size mm	WLL ton				
6	1.4				
7	1.9				
8	2.5				
10	4				
13	6.7				
16	10				
19	14				
20	16				
22	19				
26	26.5				
32	40				

2 LEGS



Chain Size mm	WLL/ton					
	0-45° chain angle	45-60° chain angle				
6	2	1.4				
7	2.65	1.9				
8	3.55	2.5				
10	5.6	4				
13	9.5	6.7				
16	14	10				
19	20	14				
20	22.4	16				
22	26.5	19				
26	37.5	26.5				
32	56	40				

Manual Hoisting
Equipments

Electric Hoisting
Equipments

Textile Sling and
Height Safety

Transport and
Load Restraints

Lifting Chain/Chain
Sling/Components

Wire Rope/Wire Rope
Sling/Components

Forestry and
Rigging Hardware

Material Handling
Equipments

GRADE 100 CHAIN SLING

3- AND 4-LEG CHAIN SLINGS

Clevis self-locking hooks or sling hooks as standard ends.
 Alternative ends are also available.
 The assemblies include a load plate
 Powder coated
 Safety factor 4 : 1

Note! The leg length of the chain assembly, unless specifically ordered, is as presented in the image L1

NOTE: option:  NFC identification

3-LEGS

Chain Size mm	WLL/ton					
	0-45° chain angle	45-60° chain angle				
6	3	2.12				
7	4	2.8				
8	5.3	3.75				
10	8.4	6				
13	14	10				
16	21.2	15				
19	30	21				
20	33.6	24				
22	40	28				
26	56	40				
32	85	60				



4-LEGS

Chain Size mm	WLL/ton					
	0-45° chain angle	45-60° chain angle				
6	3	2.12				
7	4	2.8				
8	5.3	3.75				
10	8.4	6				
13	14	10				
16	21.2	15				
19	30	21				
20	33.6	24				
22	40	28				
26	56	40				
32	85	60				



GRADE 100 CHAIN

- Use in chain slings for lifting purposes.
- Alloy steel.
- Approximately 25% stronger than Grade 80 alloy chain.
- Surface finish: blue painted or blue powder coated.
- Proof tested at 2.5 times the Working Load Limit.

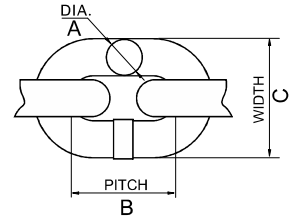

Item No.	Size (mm)	Pitch (mm)	Outside Width (mm)	WLL	Proof Load	Min. Breaking Load	Weight	Product Code
	A	B	C	T	kN	kN	kg/m	
G10S0618	6	18	22.2	1.4	35.3	56.5	0.8	
G10S0824	8	24	29.6	2.5	62.8	101	1.4	
G10S1030	10	30	37	4	98.1	157	2.2	
G10S1339	13	39	48.1	6.7	166	265	3.8	
G10S1648	16	48	59.2	10	251	402	5.7	
G10S1957	19	57	70.3	14	354	567	8.1	
G10S2060	20	60	74	16	393	628	9	
G10S2266	22	66	81.4	19	475	760	11.3	



GRADE 100 SLING COMPONENTS

GRADE 100 MASTER LINK WITH INTEGRATED GRAB HOOKS, MLS TYPE

- Fully integrated eye grab hook and master link. The hook functions as both a connecting link and shortener.
- Speedy assembly.
- Cost effective.
- Approximate 25% stronger than Grade 80.
- Quenched & tempered.
- 100% Magnaflux Crack Detection.
- Fatigue tested at 1.5 times of Working Load Limit for 20000 cycles.

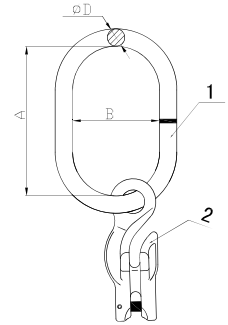

Standard: EN 1677
 Material: Alloy Steel
 Proof load: 2.5 Times the Working Load Limit
 Safety factor: 4:1
 Surface finish: Powder Coated

Item No.	Chain Size	WLL	Part 1 Main Dimensions (mm)			Part 2	Weight	Product Code
	mm	ton	A	B	D		kg	
10-MLS-06	6	1.4	110	60	13	10-EGC-06	0.64	
10-MLS-08	8	2.5	120	70	14	10-EGC-08	1.12	
10-MLS-10	10	4	140	80	17	10-EGC-10	2.08	
10-MLS-13	13	6.7	160	95	22	10-EGC-13	3.84	
10-MLS-16	16	10	190	110	25	10-EGC-16	6.75	
10-MLS-20	20	16	230	130	32	10-EGC-20	13.47	

GRADE 100 MASTER LINK WITH INTEGRATED GRAB HOOKS, MLD TYPE

- Fully integrated eye grab hooks and master link. The hooks function as both connecting links and shorteners.
- Speedy assembly.
- Cost effective.
- Approximate 25% stronger than Grade 80.
- Quenched & tempered.
- 100% Magnaflux Crack Detection.
- Fatigue tested at 1.5 times of Working Load Limit for 20000 cycles.

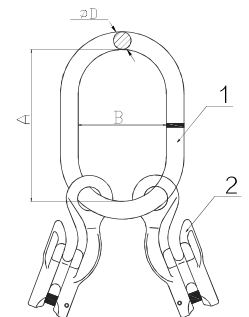

Standard: EN 1677
 Material: Alloy Steel
 Proof load: 2.5 Times the Working Load Limit
 Safety factor: 4:1
 Surface finish: Powder Coated

Item No.	Chain Size	WLL	Part 1 Main Dimensions (mm)			Part 2	Weight	Product Code
	mm	ton	A	B	D		kg	
10-MLD-06	6	2	120	70	14	10-EGC-06 X 2	1.04	
10-MLD-08	8	3.55	140	80	17	10-EGC-08 X 2	2.12	
10-MLD-10	10	5.6	160	95	22	10-EGC-10 X 2	4.15	
10-MLD-13	13	9.5	190	110	25	10-EGC-13 X 2	7	
10-MLD-16	16	14	230	130	32	10-EGC-16 X 2	13.48	

GRADE 100 SLING COMPONENTS

GRADE 100 MASTER LINK ASSEMBLY WITH INTEGRATED GRAB HOOKS, MAQ TYPE

- Fully integrated eye grab hooks and master link. The hooks function as both connecting links and shorteners.
- Speedy assembly.
- Cost effective
- Approximate 25% stronger than Grade 80.
- Quenched & tempered.
- 100% Magnaflux Crack Detection.
- Fatigue tested at 1.5 times of Working Load Limit for 20000 cycles.

Standard: EN 1677
 Material: Alloy Steel
 Proof Load: 2.5 Times the Working Load Limit
 Safety Factor: 4:1
 Surface Finish: Powder Coated

Item No.	Chain Size	WLL ton	PARTS		Weight	Product Code
	mm		1	2	kg	
10-MAQ-06	6	3	10-MLY-06	10-EGC-06 X 4	2.5	
10-MAQ-08	8	5.3	10-MLY-08	10-EGC-08 X 4	5.09	
10-MAQ-10	10	8.4	10-MLY-10	10-EGC-10 X 4	9.02	
10-MAQ-13	13	14	10-MLY-13	10-EGC-13 X 4	15.94	
10-MAQ-16	16	21.2	10-MLY-16	10-EGC-16 X 4	28.1	

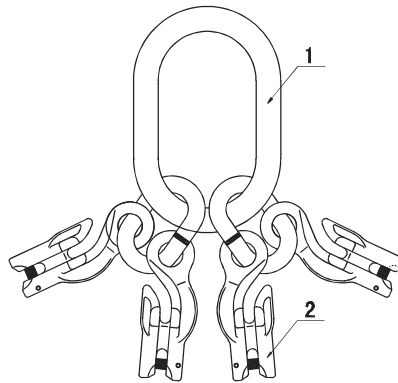

GRADE 100 SLING COMPONENTS

G100 OVERSIZED MASTER LINK, WMF TYPE

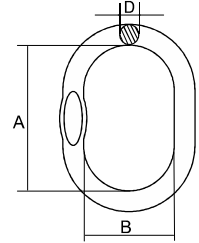

*Engineered flat for use with omega link.

*Large inside width and length to allow additional room for sling hardware and crane hook.

Item No.	WLL	BL	Main Dimensions(mm)			Weight	Product Code
	ton	ton	A	B	D	kg	
10-WMF-1008	4	16	340	180	25	3.7	
10-WMF-1310	6.7	26.8	340	180	28	4.7	
10-WMF-1613	10	40	340	180	34	7	
10-WMF-2016	16	64	340	180	38	8.9	

GRADE 100 MASTER LINK, MLF TYPE

Standard: EN1677
 Material: alloy steel - quenched and tempered
 Surface finish: powder coated
 Proof load: 2.5 times the Working Load Limit
 Safety factor: 4:1

*Engineered flat for use with omega link.

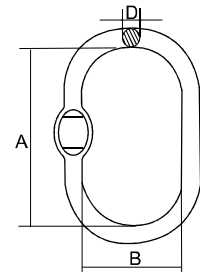

Item No.	Chain Size(mm)		WLL	Main Dimensions(mm)			Weight	Product Code
	1 leg	2 legs	ton	A	B	D	kg	
10-MLF-10	5	5	1.4	80	50	10	0.14	
10-MLF-13	6+7	6	2.3	110	60	13	0.34	
10-MLF-16	8	7	3.5	110	60	16	0.53	
10-MLF-18	10	8	5	135	75	18	0.86	
10-MLF-22	13	10	7.6	160	90	23	1.6	
10-MLF-26	16	13	10	180	100	27	2.46	
10-MLF-32	19	16	14	200	110	33	4.14	
10-MLF-36	22	19	25.1	260	140	36	6.22	
10-MLF-45	26	22	30.8	340	180	45	12.85	
10-MLF-50	32	26	40	350	190	50	16.22	
10-MLF-56	/	32	60	400	200	60	27.01	
10-MLF-70	/	/	81.5	460	250	70	45	

* 10-MLF-13 ~ 10-MLF-36: supplied with flat.

GRADE 100 SLING COMPONENTS

GRADE 100 MASTER LINK ASSEMBLY, MLY TYPE

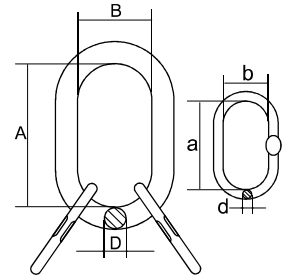

Item No.	Chain Size	WLL ton	Main Dimensions(mm)						Weight	Product Code
	mm		A	B	D	a	b	d	kg	
10-MLY-06	6	3	135	75	19	54	25	13	1.3	
10-MLY-08	8	5.3	160	90	23	70	34	16.5	2.33	
10-MLY-10	10	8.4	180	100	27	85	40	19	3.7	
10-MLY-13	13	14	200	110	33	115	50	23	6.5	
10-MLY-16	16	21.2	260	140	36	140	65	27	10.1	
10-MLY-20	19/20	33.6	350	190	50	180	90	33	22.8	
10-MLY-22	22	39.9	350	190	50	180	100	36	26	
10-MLY-26	26	56	400	200	60	180	100	45	42.6	
10-MLY-32	32	85	460	250	72	200	110	50	66.7	



GRADE 100 SLING COMPONENTS

GRADE 100 CONNECTING LINK, CNL TYPE

- Used to connect grade 100 chain to an oblong link, hook or other components.
- Approximately 25% stronger than Grade 80.
- Quenched & tempered.
- 100% Magnaflux Crack Detection.
- Fatigue tested at 1.5 times the Working Load Limit for 20000 cycles.

Standard: EN 1677
Material: forged alloy steel
Proof load: 2.5 times the Working Load Limit
Safety factor: 4:1
Surface finish: powder coated

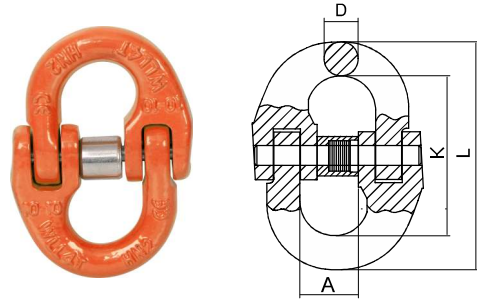

Item No.	Chain Size	WLL ton	Main Dimensions(mm)				Weight kg	Product Code
	mm		D	A	K	L		
10-CNL-06	6	1.4	7	14	44.5	61.5	0.08	
10-CNL-08	8	2.5	10	18.5	63	84	0.18	
10-CNL-10	10	4	12.6	23	71	96.2	0.34	
10-CNL-13	13	6.7	16.5	28	92.5	125	0.68	
10-CNL-16	16	10	20	33.5	106.5	147	1.22	
10-CNL-20	20	16	25	42	123	172	2.13	
10-CNL-22	22	19	27	48	137.5	191	3	
10-CNL-26	26	26.5	32	61	163	229	5.22	
10-CNL-32	32	40	40	80	197	279	9.55	

SLEEVE AND LOAD PIN



Item No.	Chain Size	Item No.	Chain Size
	mm		mm
10-SP-CNL-B-06	6	10-SP-CNL-B-18	18
10-SP-CNL-B-08	8	10-SP-CNL-B-20	18+20
10-SP-CNL-B-10	10	10-SP-CNL-B-22	22
10-SP-CNL-B-13	13	10-SP-CNL-B-26	26
10-SP-CNL-B-16	16	10-SP-CNL-B-32	32

GRADE 100 SLING COMPONENTS

- Used for shortening chain legs.
- EGK hook to be attached to the master link with the same connecting link as the chain.
- The clevis of CGK hook is used for connecting the hook to chain directly.
- No reduction of Working Load Limit due to supporting cradle in saddle of hook.
- Approximately 25% stronger than Grade 80.
- Quenched & tempered.
- 100% Magnaflux Crack Detection.
- Fatigue tested at 1.5 times the Working Load Limit for 20000 cycles.

Standard: EN 1677
 Material: forged alloy steel
 Proof load: 2.5 times the Working Load Limit
 Safety factor: 4:1
 Surface finish: powder coated

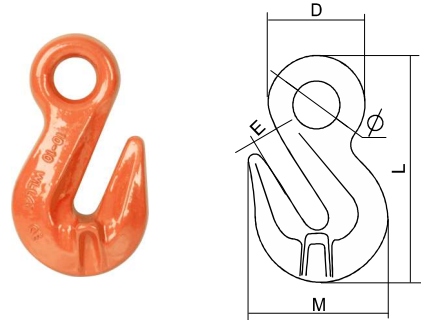

GRADE 100 EYE CRADLE GRAB HOOK, EGK TYPE

Item No.	Chain Size	WLL ton	Main Dimensions(mm)					Weight kg	Product Code
	mm		E	Ö	D	M	L		
10-EGK-06	6	1.4	8	13.5	30.5	43.5	73	0.15	
10-EGK-08	8	2.5	11	17.5	37	53	93	0.3	
10-EGK-10	10	4	13.5	22	48.5	74	129	0.79	
10-EGK-13	13	6.7	16.5	28	59	96	166	1.67	
10-EGK-16	16	10	19	36	75	116	186	2.74	
10-EGK-20	20	16	24	43.5	89.5	143	227	4.72	
10-EGK-22	22	19	27	48.5	100.5	160.5	260.5	8.2	
10-EGK-26	26	26.5	34	52	120	190	311	11.35	
10-EGK-32	32	40	41	64	144	229	373	20.65	

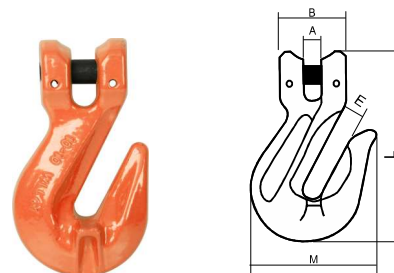

GRADE 100 CLEVIS CRADLE GRAB HOOK, CGK TYPE

Item No.	Chain Size	WLL ton	Main Dimensions(mm)					Weight kg	Product Code
	mm		A	B	E	M	L		
10-CGK-06	6	1.4	7.5	32	8	43.5	77.3	0.22	
10-CGK-08	8	2.5	9.5	36	11	54	93	0.34	
10-CGK-10	10	4	12.5	46	13.5	72	127	0.82	
10-CGK-13	13	6.7	15	59	15	96	164	1.75	
10-CGK-16	16	10	18.5	70	19	115	188	2.88	
10-CGK-20	20	16	24	85	24	142	221	4.84	
10-CGK-22	22	19	27	100	27	159	260	8.3	

Manual Hoisting
EquipmentsElectric Hoisting
EquipmentsTextile Sling and
Height SafetyTransport and
Load RestraintsLifting Chain/Chain
Sling/ComponentsWire Rope/Wire Rope
Sling/ComponentsForestry and
Rigging HardwareMaterial Handling
Equipments

GRADE 100 SLING COMPONENTS

GRADE 100 CLEVIS SLING HOOK WITH LATCH, CSH TYPE

- Lifting chain is attached directly to the hook without a connecting link.
- Approximately 25% stronger than Grade 80.
- Quenched & tempered.
- 100% Magnaflux Crack Detection.
- Fatigue tested at 1.5 times the Working Load Limit for 20000 cycles.

Standard: EN 1677
Material: forged alloy steel
Proof load: 2.5 times the Working Load Limit
Safety factor: 4:1
Surface finish: powder coated

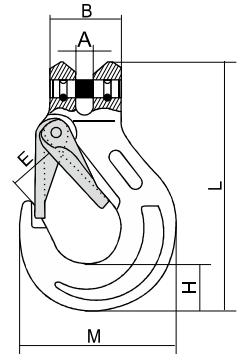

Item No.	Chain Size	WLL ton	Main Dimensions(mm)						Weight	Product Code
	mm		A	B	E	H	M	L	kg	
10-CSH-06	6	1.4	7.5	32	18.5	21	68.5	109	0.33	
10-CSH-08	8	2.5	9.5	37	25	27.5	88	134	0.7	
10-CSH-10	10	4	12	48	28	33.5	105.5	161.5	1.3	
10-CSH-13	13	6.7	15	59	38	42	134	203	2.3	
10-CSH-16	16	10	18.5	70	44	50	160.5	248	3.6	
10-CSH-20	20	16	25	85	52	56	190.5	297	7	
10-CSH-22	22	19	27	100	66	62	214.5	326	12.1	
10-CSH-26	26	26.5	30.5	118	72	73	248	383	16.1	
10-CSH-32	32	40	37.5	149	87	87	281	474	27.2	

LOAD PIN FOR SLING HOOK/CSH, GRAB HOOK/CGK AND SELF LOCKING HOOK/CSK



Item	Chain Size	Item	Chain Size
	mm		mm
10-SP-CK-06	6	10-SP-CK-16	16
10-SP-CK-08	8	10-SP-CK-20	20
10-SP-CK-10	10	10-SP-CK-22	22
10-SP-CK-13	13	/	/

GRADE 100 SLING COMPONENTS

GRADE 100 EYE SLING HOOK WITH SAFETY LATCH, ESH TYPE

- Comes with spring-loaded safety latch.
- Approximately 25% stronger than Grade 80.
- Quenched & tempered.
- 100% Magnaflux Crack Detection.
- Fatigue tested at 1.5 times the Working Load Limit for 20000 cycles.

Standard: EN 1677
Material: forged alloy steel
Proof load: 2.5 times the Working Load Limit
Safety factor: 4:1
Surface finish: powder coated

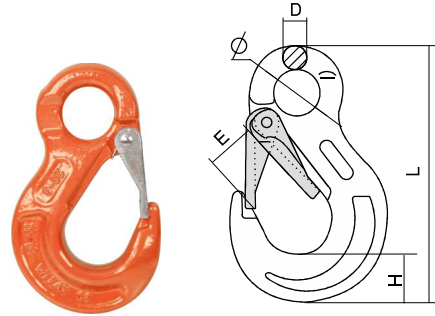

Item No.	Chain Size	WLL ton	Main Dimensions(mm)					Weight kg	Product Code
	mm		D	E	H	Φ	L		
10-ESH-06	6	1.4	10	18.5	21	20.5	111	0.32	
10-ESH-07	7	1.9	11	25.5	26	25	137	0.4	
10-ESH-08	8	2.5	11	25	27.5	25	137	0.6	
10-ESH-10	10	4	16	29.5	32	35	171.5	1.2	
10-ESH-13	13	6.7	19	38	43.5	43	219	2.2	
10-ESH-16	16	10	24.5	46	50	51	260	3.5	
10-ESH-20	20	16	27	52	56	55	298	6.2	
10-ESH-22	22	19	29	66	62	60	330	11.5	
10-ESH-26	26	26.5	35	73	75	70	376	12.2	
10-ESH-32	32	40	39	87	89	81.5	458	17.5	

LATCH KITS FOR ESH AND CSH TYPE SLING HOOK



Item No.	Chain Size	Item No.	Chain Size
	mm		mm
10-SP-SH-06	6	10-SP-SH-16	16
10-SP-SH-07	7	10-SP-SH-20	20
10-SP-SH-08	8	10-SP-SH-22	22
10-SP-SH-10	10	10-SP-SH-26	26
10-SP-SH-13	13	10-SP-SH-32	32

GRADE 100 SLING COMPONENTS

- Safety hooks will not open when under load as the latch closes automatically.
- The clevis of CSK hook is used for connecting the hook to chain directly.
- Approximately 25% stronger than Grade 80.
- Quenched & tempered.
- 100% Magnaflux Crack Detection.
- Fatigue tested at 1.5 times the Working Load Limit for 20000 cycles.

Standard: EN 1677
 Material: forged alloy steel
 Proof load: 2.5 times the Working Load Limit
 Safety factor: 4:1
 Surface finish: powder coated

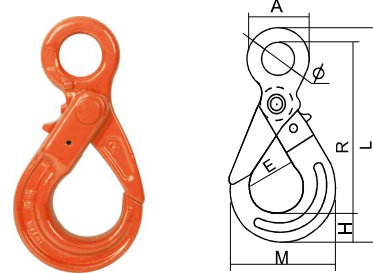

GRADE 100 EYE SELF LOCKING HOOK , ESK TYPE

Item No.	Chain Size	WLL	Main Dimensions(mm)							Weight	Product Code
	mm		ton	Ö	A	E	H	R	M		
10-ESK-06	6	1.4	21	43	27	20	110	70	141	0.5	
10-ESK-08	8	2.5	27	51	35	26	137	90	175	0.9	
10-ESK-10	10	4	34.5	64.5	43	27	170	108	212	1.5	
10-ESK-13	13	6.7	40	80	51.5	40.5	209	137.5	269	2.7	
10-ESK-16	16	10	50	104	59	50.5	256	170.5	333	5.7	
10-ESK-20	20	16	60	124	74.5	62	277	191.5	368.5	7.9	
10-ESK-22	22	19	70	139	78	66	319	205	417	11.2	

GRADE 100 CLEVIS SELF LOCKING HOOK , CSK TYPE

Item No.	Chain Size	WLL	Main Dimensions(mm)							Weight	Product Code
	mm		ton	A	B	E	H	R	M		
10-CSK-06	6	1.4	8	32	28	20	96	70	131	0.5	
10-CSK-08	8	2.5	9.5	36	36	26	121	90	163	0.9	
10-CSK-10	10	4	12	46	45	27	144	109	196.5	1.6	
10-CSK-13	13	6.7	15	59	53.5	40.5	182	137	251	2.9	
10-CSK-16	16	10	18.5	70	61	50.5	220	168	303	5.8	
10-CSK-20	20	16	25	85	76.5	62	235	190	337	8.6	
10-CSK-22	22	19	25.5	98	80	66	271	202	386	12.1	
10-CSK-26	26	26.5	30	118	99	80	343	251	484	21.15	
10-CSK-32	32	40	35	150	135	101.5	423	329	601	43.4	

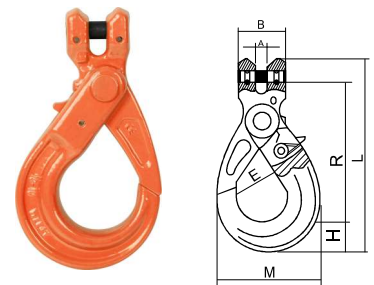

TRIGGER KITS FOR ESK,CSK, SSK AND SSB TYPE SELF LOCKING HOOK



Item No.	Chain Size	Item No.	Chain Size
	mm		mm
10-SP-CK-06	6	10-SP-CK-16	16
10-SP-CK-08	8	10-SP-CK-20	20
10-SP-CK-10	10	10-SP-CK-22	22
10-SP-CK-13	13	/	/

GRADE 100 SLING COMPONENTS

- Swivel eye allows for 360 degrees rotation before load is applied.
- Safety hooks will not open when under load as the latch closes automatically.
- SSB type hook with ball bearing can rotate easily also with full load.
- Approximately 25% stronger than Grade 80.
- Quenched & tempered.
- 100% Magnaflux Crack Detection.
- Fatigue tested at 1.5 times the Working Load Limit for 20000 cycles.

Standard: EN 1677
 Material: forged alloy steel
 Proof load: 2.5 times the Working Load Limit
 Safety factor: 4:1
 Surface finish: powder coated

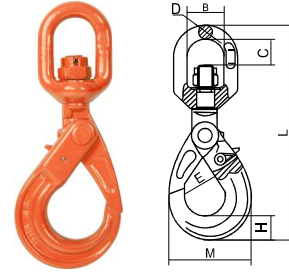

GRADE 100 SWIVEL SELF LOCKING HOOK, SSK TYPE

Item No.	Chain Size	WLL	Main Dimensions(mm)							Weight	Product Code
	mm	ton	B	C	D	E	H	M	L	kg	
10-SSK-06	6	1.4	32.5	23	11.5	27	20	70	184	0.6	
10-SSK-08	8	2.5	36	27.5	13	35	25	90	226	1.1	
10-SSK-10	10	4	42	33	15.5	43	28	108	269	2	
10-SSK-13	13	6.7	50	39	17	51.5	40	137.5	327	4	
10-SSK-16	16	10	70	56	21.5	59	49.5	170.5	413	6.8	
10-SSK-20	20	16	72	61	26	74.5	61	191.5	460	12.5	
10-SSK-22	22	19	97	96	33	78	65	205	566	17.1	

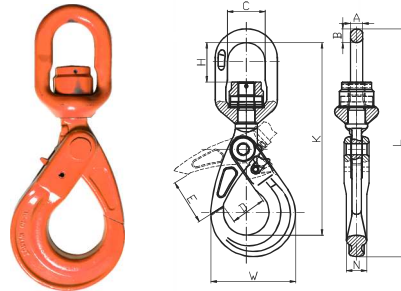

GRADE 100 SWIVEL SELF LOCKING HOOK WITH BEARING, SSB TYPE

Item No.	Chain Size	WLL	Main Dimensions(mm)										Weight	Product Code
	mm	ton	A	B	C	D	E	N	H	K	L	W	kg	
10-SSB-06	6	1.4	11.5	13	37	27	30	15	32	163	196.5	70	0.67	
10-SSB-08	8	2.5	13	15	41	35.5	40	20	39	202	243	90	1.21	
10-SSB-10	10	4	15.5	17.5	48	45	48	26	48	244	289	108	2.2	
10-SSB-13	13	6.7	17	19	55	52.5	63	32.5	57	292	351	138	4.4	
10-SSB-16	16	10	21.5	26	62	62	75	38	62	346	422	170	7.48	
10-SSB-20	20	16	26.5	28.5	76	76	80	50	72	396	487	191	13.75	
10-SSB-22	22	19	33	33	97	79	95	52	97	465	563	208	18.81	
10-SSB-26	26	26.5	42	42	123	100	107	60	119	565	688	253	31.4	
10-SSB-32	32	40	52	52	152	135	142	75	153	688	842	329	61	

GRADE 100 SLING COMPONENTS

GRADE 100 OMEGA LINK, OML TYPE

- Used as a chain end fitting to form an effective and robust connecting link.
- Approximately 25% stronger than Grade 80.
- Quenched & tempered.
- 100% Magnaflux Crack Detection.
- Fatigue tested at 1.5 times the Working Load Limit for 20000 cycles.

Standard: EN 1677
 Material: forged alloy steel
 Proof load: 2.5 times the Working Load Limit
 Safety factor: 4:1
 Surface finish: powder coated

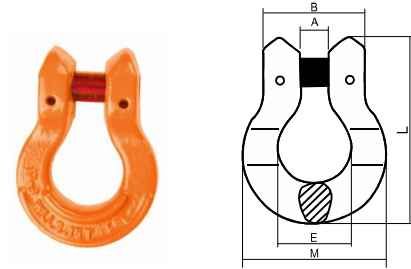

Item No.	Chain Size	WLL	Main Dimensions(mm)					Weight	Product Code
	mm		ton	A	B	E	M	L	
10-OML-06	6	1.4	8.5	32.5	20	44	55	0.12	
10-OML-08	8	2.5	10.5	42	24	60	73.5	0.27	
10-OML-10	10	4	12.5	48.5	31	70	90	0.44	
10-OML-13	13	6.7	16	60	38.8	90	109	0.89	
10-OML-16	16	10	19	75.5	51	112	141.5	1.77	

GRADE 100 CLEVIS C HOOK, CCK TYPE

- The hook tip is shaped to prevent accidental unhooking when not under load.
- Lifting chain is attached directly to the hook without a connecting link.
- Only for applications without safety catch requirement.
- Approximately 25% stronger than Grade 80.
- Quenched & tempered.
- 100% Magnaflux Crack Detection.
- Fatigue tested at 1.5 times the Working Load Limit for 20000 cycles.

Standard: EN 1677
 Material: forged alloy steel
 Proof load: 2.5 times the Working Load Limit
 Safety factor: 4:1
 Surface finish: powder coated

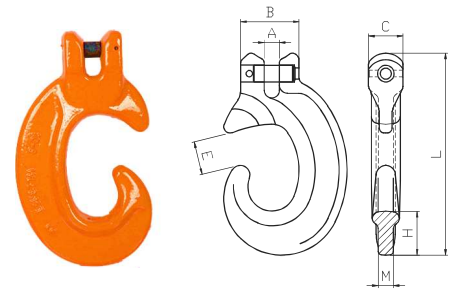

Item No.	Chain Size	WLL	Main Dimensions (mm)							Weight	Product Code
	mm		ton	A	B	C	H	L	M	E	
10-CCK-08	7+8	2.5	9.5	36.5	21.5	27.3	125.5	9.5	20.5	0.54	
10-CCK-10	10	4	12.5	48.5	27	32.4	169	12	27	1.05	

GRADE 100 SLING COMPONENTS

GRADE 100 CONTAINER LIFTING CLEVIS LINK, CLK TYPE

- With the locking system and spring locking pin to enhance security and prevent the chains from disengaging.
- Approximately 25% stronger than Grade 80.
- Quenched & tempered.
- 100% Magnaflux Crack Detection.
- Fatigue tested at 1.5 times the Working Load Limit for 20000 cycles.

Standard: EN 1677
 Material: forged alloy steel
 Proof load: 2.5 times the Working Load Limit
 Safety factor: 4:1
 Surface finish: powder coated

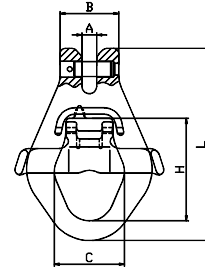

Item No.	Chain Size	WLL ton	Main Dimensions(mm)					Weight kg	Product Code
	mm		A	B	C	H	L		
10-CLK-13	13	6.7	15.5	60	71.5	104	195	1.9	

GRADE 100 CLEVIS SHACKLE, CSL TYPE

- Designed specifically for use as a terminal end fitting with a clevis connection directly to chain.
- Approximately 25% stronger than Grade 80.
- Quenched & tempered.
- 100% Magnaflux Crack Detection.
- Fatigue tested at 1.5 times the Working Load Limit for 20000 cycles.

Standard: EN 1677
 Material: forged alloy steel
 Proof load: 2.5 times the Working Load Limit
 Safety factor: 4:1
 Surface finish: powder coated

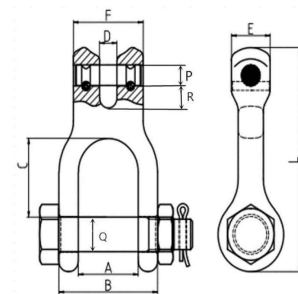

Item No.	Chain Size	WLL ton	Main Dimensions(mm)										Weight kg	Product Code
	mm		A	B	C	D	E	F	L	P	R	Q		
10-CSL-08	8	2.5	31	51	36.3	9	20	36	103.5	9.7	10.3	16	0.48	
10-CSL-10	10	4	34	62	48	12.5	25	46.5	130.7	12.2	13	20	0.89	
10-CSL-13	13	6.7	49	83	64	15	31	59	160	16	17	22	1.51	
10-CSL-16	16	10	58	95	69.5	19	40	70	190.5	19.7	20.5	28.5	2.62	

GRADE 100 SLING COMPONENTS

GRADE 100 SPECIAL EYE GRAB HOOK WITH SAFETY PIN, SEG TYPE

- Used for shortening chains.
- Hook to be attached to the master link with the same connecting link as the chain.
- No reduction of Working Load Limit due to supporting cradle in saddle of hook.
- Hook with safety pin which prevents chain from falling out.
- Approximately 25% stronger than Grade 80.
- Quenched & tempered.
- 100% Magnaflux Crack Detection.
- Fatigue tested at 1.5 times the Working Load Limit for 20000 cycles.

Standard: EN 1677
 Material: forged alloy steel
 Proof load: 2.5 times the Working Load Limit
 Safety factor: 4:1
 Surface finish: powder coated

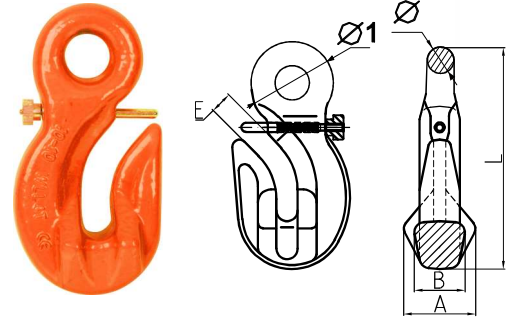

Item No.	Chain Size	WLL	Main Dimensions(mm)						Weight	Product Code
	mm	ton	A	B	Ø	Ø1	E	L	kg	
10-SEG-08	8	2.5	35	25	12	16.5	10.5	110	0.5	
10-SEG-10	10	4	44	32	15	21	13	136.5	1	
10-SEG-13	13	6.7	57	40	20.5	27.5	15.5	180	2.2	

GRADE 100 SPECIAL CLEVIS GRAB HOOK WITH SAFETY PIN, SCG TYPE

- Used for shortening chains.
- No reduction of Working Load Limit due to supporting cradle in saddle of hook.
- Lifting chain is attached directly to the hook without a connecting link.
- Approximately 25% stronger than Grade 80.
- Quenched & tempered.
- 100% Magnaflux Crack Detection.
- Fatigue tested at 1.5 times the Working Load Limit for 20000 cycles.

Standard: EN 1677
 Material: forged alloy steel
 Proof load: 2.5 times the Working Load Limit
 Safety factor: 4:1
 Surface finish: powder coated

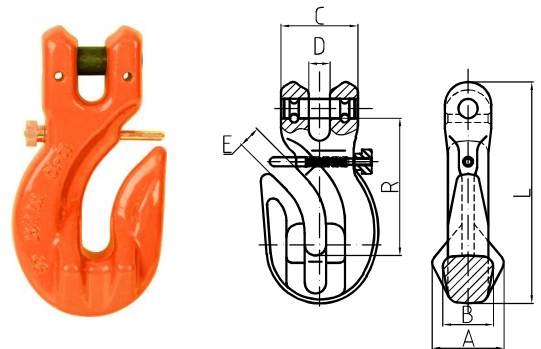

Item No.	Chain Size	WLL	Main Dimensions(mm)							Weight	Product Code
	mm	ton	A	B	C	R	D	E	L	kg	
10-SCG-08	8	2.5	35.5	25	38	66	10	10.5	109	0.62	
10-SCG-10	10	4	44	32	46	82	12	13	134	1.16	
10-SCG-13	13	6.7	57	40	59.5	107	15	15.5	175.5	2.6	

GRADE 100 SLING COMPONENTS

GRADE 100 SHORTENING CLUTCH LOCKING TYPE, SCL TYPE

- Used for shortening the chain legs.
- Additional locking pin to prevent chain from falling out.
- Approximately 25% stronger than Grade 80.
- Quenched & tempered.
- 100% Magnaflux Crack Detection.
- Fatigue tested at 1.5 times of Working Load Limit for 20000 cycles.

Standard: EN 1677
 Material: forged alloy steel
 Proof load: 2.5 times the Working Load Limit
 Safety factor: 4:1
 Surface finish: powder coated

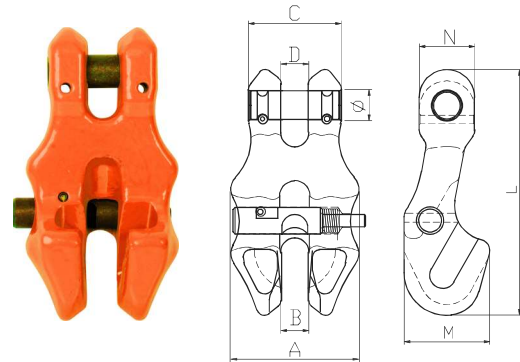

Item No.	Chain Size	WLL	Main Dimensions(mm)								Weight	Product Code
	mm	ton	A	B	C	D	M	N	Ø	L	kg	
10-SCL-06	6	1.4	38	7.5	27	7.5	29	16	7.7	73	0.25	
10-SCL-08	8	2.5	50	9.5	33	9.5	36	23	9.2	92	0.41	
10-SCL-10	10	4	60	11.7	43.5	11.7	45.4	26	13.3	115	0.75	
10-SCL-13	13	6.7	79	15	55	15	54	34	16.3	149	1.67	
10-SCL-16	16	10	98	19	70	19	70	40	19.7	184	4.2	

GRADE 100 SYNTHETIC SLING HOOK (JOKER HOOK), SSH TYPE

- Designed for using with webbing slings and roundslings.
- Enlarged shoulder areas to protect slings from chaffing.
- Colour coded to the lifting sling.
- Quenched & tempered.
- 100% Magnaflux Crack Detection.
- Fatigue tested at 1.5 times the Working Load Limit for 20000 cycles.

Standard: EN 1677
 Material: forged alloy steel
 Proof load: 2.5 times the Working Load Limit
 Safety factor: 4:1
 Surface finish: powder coated

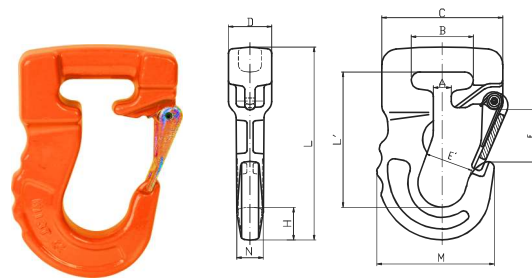

Item No.	WLL	BL	Main Dimensions(mm)											Weight	Product Code
	ton	ton	A	B	C	D	M	N	E	E'	L	L'	H	kg	
10-SSH-01	1	4	11.5	40	78	28	75.7	17	33	30	124	87	21	0.73	
10-SSH-02	2	8	18.5	44.5	91	35	90	21	40	39	148	103	27	1.27	
10-SSH-03	3	12	21.5	54	114	45	110	26	41	48	175	115	33	2.3	
10-SSH-04	4	16	40.5	76	133	56	139	32	50.5	60	223.5	147	40.5	4.73	
10-SSH-05	5	20	40.5	76	133	56	139	32	50.5	60	223.5	147	40.5	4.73	
10-SSH-06	6	24	40.5	76	133	56	139	32	50.5	60	223.5	147	40.5	4.73	

GRADE 100 SLING COMPONENTS

GRADE 100 HALF LINK SHORTENING HOOK WITH CLEVIS ATTACHMENT, HSC TYPE

- Designed to avoid the extra chain connector in the shortening link and extra chain connector to the master link.
- Approximately 25% stronger than Grade 80.
- Quenched & tempered.
- 100% Magnaflux Crack Detection.
- Fatigue tested at 1.5 times of Working Load Limit for 20000 cycles.

Standard: EN 1677
Material: forged alloy steel
Proof load: 2.5 times the Working Load Limit
Safety factor: 4:1
Surface finish: powder coated

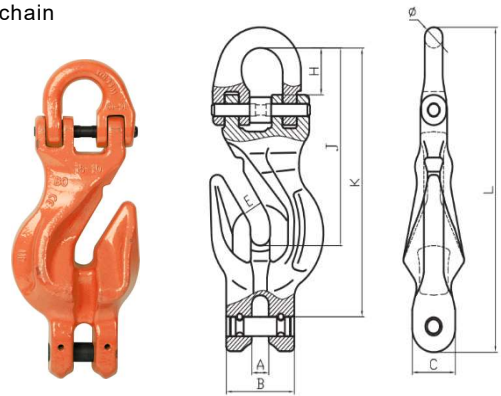

Item No.	Chain Size	WLL	Main Dimensions (mm)									Weight	Product Code
	mm		ton	A	B	C	E	H	L	K	J		
10-HSC-06	6	1.4	8	32	18	8.3	16	1287	104.7	80	7	0.366	
10-HSC-08	8	2.5	9.5	37	24	10.5	25	165	136	100	10	0.79	
10-HSC-10	10	4	12.5	48	29.5	13	28	203	167	123	12.6	1.522	
10-HSC-13	13	6.7	16	59	37	15.5	37	269	223	163	16.5	3.372	
10-HSC-16	16	10	18.5	70	46	18.5	40	328	271	194	20	5.67	
10-HSC-20	20	16	24	85	52	25	46	398	328	247	25	9.79	
10-HSC-22	22	19	25	100	61	26.5	51.5	430	354	258	27	14.62	

GRADE 100 CLEVIS REEVING LINK, CRL TYPE

- Designed for use in reeveable slings as top or terminal end fittings.
- Approximately 25% stronger than Grade 80.
- Quenched & tempered.
- 100% Magnaflux Crack Detection.
- Fatigue tested at 1.5 times the Working Load Limit for 20000 cycles.

Standard: EN 1677
Material: forged alloy steel
Proof load: 2.5 times the Working Load Limit
Safety factor: 4:1
Surface finish: powder coated

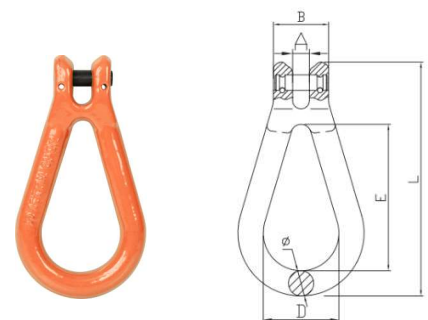

Item No.	Chain Size	WLL	Main Dimensions(mm)						Weight	Product Code
	mm		ton	A	B	D	E	∅		
10-CRL-13	13	6.7	16.5	55.5	66.5	137.5	22	228	1.76	
10-CRL-16	16	10	19	68	72	165	26	264	2.8	



Manual Hoisting
Equipments

Electric Hoisting
Equipments

Textile Sling and
Height Safety

Transport and
Load Restraints

Lifting Chain/Chain
Sling/Components

Wire Rope/Wire Rope
Sling/Components

Forestry and
Rigging Hardware

Material Handling
Equipments

WIRE ROPE

THE DEFINITION OF THE WIRE ROPE

Steel wire ropes consist of at least 4 strands wrapped around a core made of polypropylene, steel or fiber. Each strand and steel are wound like a spiral in a different composition.

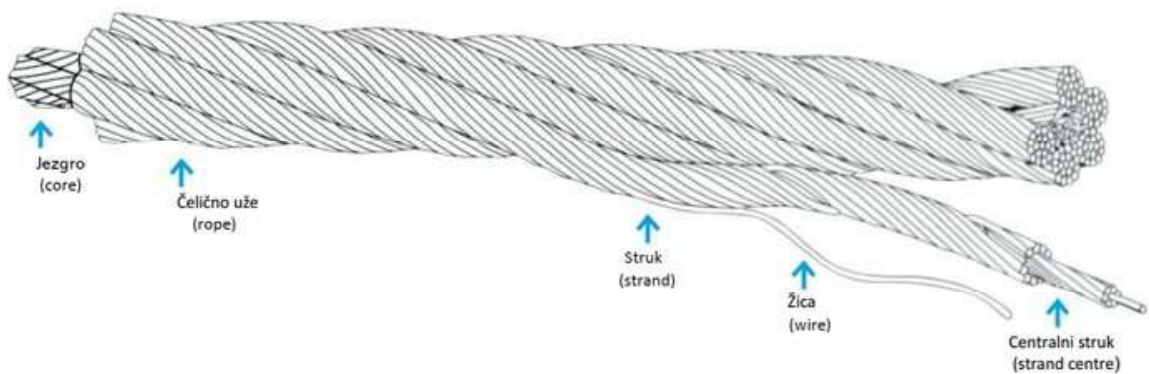

LAY OF WIRE ROPE:

Generally speaking, steel ropes can be twisted in two ways: with standard twisting and Lang twisting.

REGULAR LAY WIRE ROPE

The direction of the wire lay in the strand is opposite to the direction of the lay in the rope. It is two kind; right regular lay “s/Z”, and left regular lay “z/S” these are constructed like below shapes.

LANG LAY WIRE ROPE:

Both strand lay and rope lay are in the same direction. There are two types; right lang lay lay “z/Z” and left lang lay “s/S” these are constructed like bellow shapes.

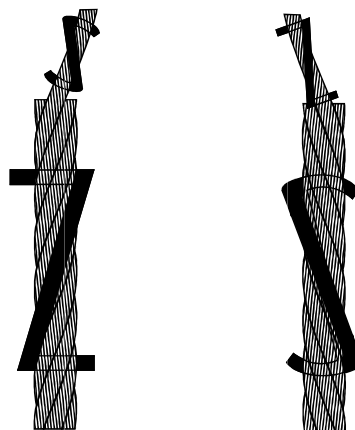

THE DEFINITION OF THE WIRE ROPE

MEASURING THE WIRE ROPE:

In order to measure the diameter of the steel wire ropes, the following certain instructions should be followed;

1. First, a sample of wire rope is held straight and without any load exerted on it.
2. Second, it should be begin at least 1.5 mt. from the end, while measuring the diameter of the rope.
3. Third, two measurements are done 1.5 mt. intervals from the two points. Every measurements point should be vertical to each other.
4. Last, real diameter of the steel wire ropes is defined as the average of these four measurements.

As seen below diagrams (1st diagram is a correct measurement of the diameter and 2nd diagram is an incorrect measurement of the diameter of the steel wire ropes). Diameter tolerances for the standard wire rope vary from -%0, + %5 (lower tolerance is -%0, and upper tolerance +%5).

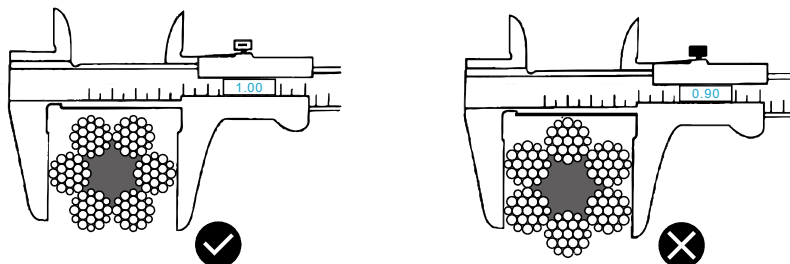

HOW TO UNCOIL AND REWIND THE WIRE ROPE:

The uncoiling and rewinding is the most important thing finished wire rope. If we want to avoid kinks and defects in to the rope it should be considered below illustration.



NOTE: option:  NFC identification

WIRE ROPE

THE DEFINITION OF THE WIRE ROPE

HOW TO CUT ROPE:

When we cut the rope we have to wrap both side of rope with low carbon steel wire or pipe clip as shown at the following illustrations.

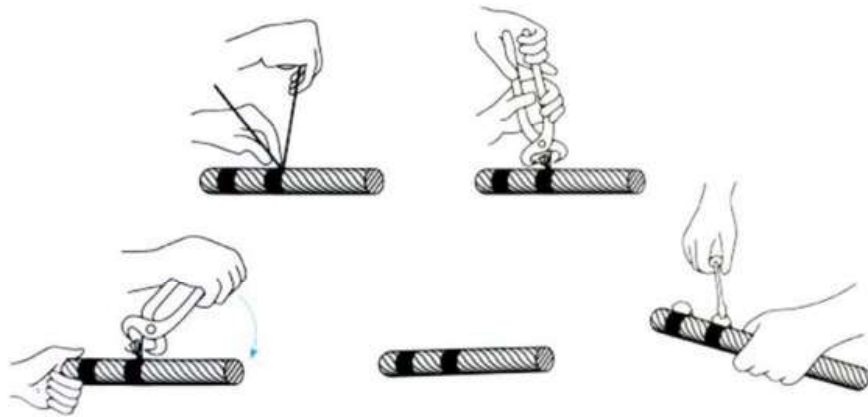

When ordering steel wire ropes, please clarify following specifications:

1. Diameter of rope (- / + tolerances)
2. Wire rope length (- / + tolerances)
3. Construction of wire rope
4. Core construction of the wire rope (IWRC/FC)
5. Additional breaking load / minimum breaking load
6. Type of laying (Zs, Sz, Zz, Ss)
7. Surface protection (Ungalvanized / Galvanized / PVC-coated)
8. Kind of lubricant
9. Packing (Coil, Wooden drum)
10. Delivery Terms
11. Delivery address
12. Type of rope termination (annealed rope end, cut end, socketed end, swaged ends)

If you have any specific inquiry please contact us these information will enable us to clear you inquiry.

Bosna i Hercegovina
Laktaši: +387 (0) 51 259 360
Email: info@hidraulikaflex.com

Sarajevo: +387 (0) 33 743-905
Email: info@hidraulikaflexsa.ba

Srbija - Beograd
Tel: +381 (0) 69 708 359
Email: info@hflifting.rs

WIRE ROPE / SLING END TERMINATIONS



Swaged round sleeve

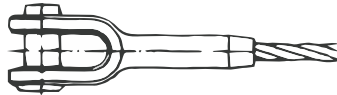

Swaged open socket

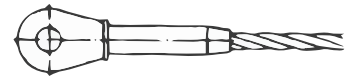

Swaged closed socket

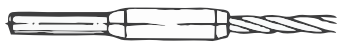

Swaged threaded stud



Swaged threaded sleeve



Wedge type socket

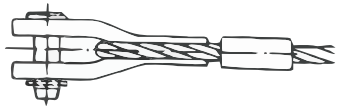

Aluminium swaged open socket

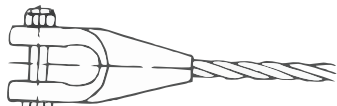

Open socket, socketed



Wire rope grip



Hand spliced eye



Spliced thimble

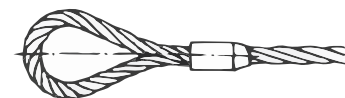

Flemish eye splice

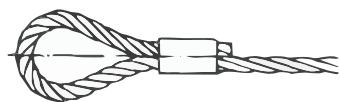

Aluminium swaged eye

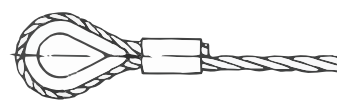

Aluminium swaged thimble

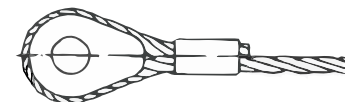

Aluminium swaged solid thimble

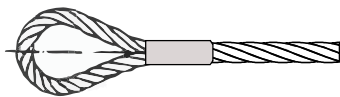

Aluminium swaged eye (Conical aluminium ferrules)

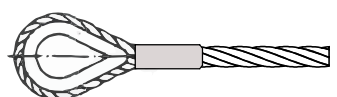

Aluminium swaged thimble (Conical aluminium ferrules)

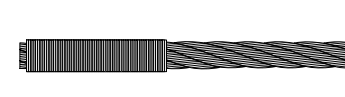

Seized and cut

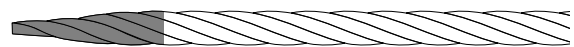

Annealed rope end

NOTE: option:  NFC identification



WIRE ROPE

Manual Hoisting
Equipments

Electric Hoisting
Equipments

Textile Sling and
Height Safety

Transport and
Load Restraints

Lifting Chain/Chain
Sling/Components

Wire Rope/Wire Rope
Sling/Components

Forestry and
Rigging Hardware

Material Handling
Equipments

Preporučena upotreba čeličnih užadi prema njihovoj konstrukciji Recommended use of steel ropes according to their construction

Konstrukcija Construction	Industrija Mining	Naftna industrija Oil Industry	Kran Crane	Dizalice Hoist	Lift Elevators	Zdore Aerial Tramway	Marina Marina	Ribarstvo Fishing	Šumarstvo Logging	Brodogradnja / jahte Ship and Yacht	Opšte upotrebe General Engineering
607 IWRC/Č		X				X	X				
607 FCV	X				X	X	X				
6415 SEALE FCV	X	X						X			X
6072 SEALE FCV	X	X						X			X
6419 SEALE IWRC/Č	X	X	X	X				X	X		X
6419 SEALE FCV	X	X	X	X	X	X		X	X		X
6419 WARRINGTON IWRC/Č	X	X	X	X				X	X		X
6419 WARRINGTON FCV	X	X	X	X	X	X		X	X		X
6419 FILLER IWRC/Č	X	X	X	X					X		X
6419 FILLER FCV	X	X	X	X	X				X		X
6419 STANDARD IWRC/Č	X	X	X	X					X		X
6419 STANDARD FCV	X	X	X	X	X			X	X		X
6426 WARRINGTON SEAL IWRC/Č	X	X									X
6426 WARRINGTON SEAL FCV	X	X									X
6431 WARRINGTON SEAL IWRC/Č	X	X	X	X							X
6431 WARRINGTON SEAL FCV	X	X	X	X	X						X
6436 WARRINGTON SEAL IWRC/Č	X	X	X	X							X
6436 WARRINGTON SEAL FCV	X	X	X	X	X						X
6437 STANDARD IWRC/Č	X	X									X
6437 STANDARD FCV	X	X									X
6441 WARRINGTON SEAL IWRC/Č	X	X	X	X							X
6441 WARRINGTON SEAL FCV	X	X	X	X	X						X
6419 SEALE IWRC/Č		X	X	X	X	X					X
6419 SEALE FCV		X	X	X	X	X					X
6419 WARRINGTON IWRC/Č		X	X	X	X	X					X
6419 WARRINGTON FCV		X	X	X	X	X					X
6419 FILLER IWRC/Č		X	X	X	X	X					X
6419 FILLER FCV		X	X	X	X	X					X
6436 WARRINGTON SEAL IWRC/Č		X	X	X							X
6436 WARRINGTON SEAL FCV		X	X	X	X						X
1807 NIROTMAJUČE IWRC/Č	X	X	X	X			X				X
1807 NIROTMAJUČE FCV	X	X	X	X			X			X	X

Steel Wire Ropes - Stainless steel ropes

Prečnik užeta Rope Dia. mm	Težina Unit Weight kg/100 m	Zatezna čvrstoča Wire Tensile
		1570 N/mm ²
		Minimalna prekidna sila (MBL) kN
1.00	0.38	0.56
1.50	0.86	1.27
2.00	1.54	2.25
2.50	2.40	3.52
3.00	3.50	5.10
4.00	6.10	9.00
5.00	9.60	14.10
6.00	13.80	20.30
8.00	24.60	36.10

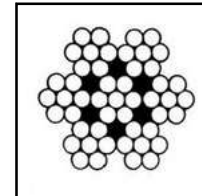

7X7

EN12385



Prečnik užeta Rope Dia. mm	Težina Unit Weight kg/100 m	Zatezna čvrstoča Wire Tensile
		1570 N/mm ²
		Minimalna prekidna sila (MBL) kN
2.00	1.52	2.27
2.50	2.38	3.55
3.00	3.43	5.10
4.00	6.10	9.10
5.00	9.50	14.20
6.00	13.70	20.50
8.00	24.40	36.40
9.00	30.90	46.00
10.00	38.10	56.80
12.00	54.90	81.80

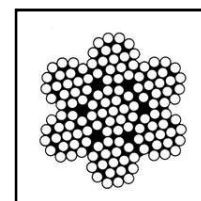

7X19

EN12385

WIRE ROPE

Coated Steel Wire Ropes

Prečnik užeta Rope Dia. mm	Težina Unit Weight kg/100m	Zatezna čvrstoča Wire Tensile
		1770 N/mm ²
		Minimalna prekidna sila (MBL) kN
2/3	2.00	2.35
3/4	4.00	5.29
3/5	5.00	5.29
4/5	6.70	9.41
4/6	8.00	9.41
5/6	10.10	14.70
6/8	16.00	21.10
8/10	29.90	37.60

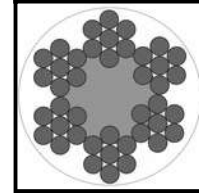

6X7
EN12385-4
JUS C.H1.070
DIN 3055



Prečnik užeta Rope Dia. mm	Težina Unit Weight kg/100m	Zatezna čvrstoča Wire Tensile
		1770 N/mm ²
		Minimalna prekidna sila (MBL) kN
3/4	3.90	4.90
3/5	4.90	4.90
4/5	6.50	8.70
4/6	7.80	8.70
5/6	9.90	13.60
6/8	15.60	19.60
8/10	26.20	34.80
10/12	39.60	54.40
12/14	55.70	78.30

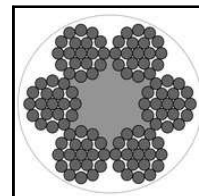

6X19
EN12385-4

Steel Wire Ropes/Single Stranded Ropes

Prečnik užeta Rope Dia. mm	Težina Unit Weight kg/m	Zatezna čvrstoća / Wire Tensile		
		1180 N/mm ²	1570 N/mm ²	1770 N/mm ²
		Minimalna prekidna sila kN Minimum Breaking Load (MBL) kN		
2.00	0.020	2.5	3.3	3.8
2.50	0.031	3.9	5.2	5.9
3.00	0.045	5.7	7.5	8.5
3.50	0.061	7.7	10.3	11.6
4.00	0.080	10.1	13.4	15.1
4.50	0.101	12.7	16.9	19.1
5.00	0.125	15.7	20.9	23.6
5.50	0.151	19.0	25.3	28.5
6.00	0.180	22.6	30.1	34.0
6.50	0.211	26.6	35.4	39.9
7.00	0.245	30.8	41.0	46.2
7.50	0.281	35.4	47.1	53.1
8.00	0.320	40.3	53.6	60.4
8.50	0.361	45.4	60.5	68.2
9.00	0.405	50.9	67.8	76.4
9.50	0.451	56.8	75.5	85.1
10.00	0.500	62.9	83.7	94.3
10.50	0.551	69.3	92.3	104.0
11.00	0.605	76.1	101.3	114.2
11.50	0.661	83.2	110.7	124.8
12.00	0.720	90.6	120.5	135.9

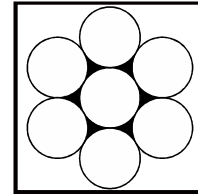

1X7=1X(1+6)
EN12385-10
JUS C.H1.060
DIN 3052



WIRE ROPE

Steel Wire Ropes/Single Stranded Ropes

Prečnik užeta Rope Dia. mm	Težina Unit Weight kg/m	Wire Tensile		
		1180 N/mm ²	1570 N/mm ²	1770 N/mm ²
		Minimum Breaking Load (MBL) kN		
2.00	0.020	2.5	3.3	3.7
2.50	0.031	3.9	5.2	5.8
3.00	0.045	5.6	7.5	8.4
3.50	0.061	7.6	10.2	11.4
4.00	0.080	10.0	13.3	15.0
4.50	0.101	12.6	16.8	18.9
5.00	0.125	15.6	20.7	23.4
5.50	0.151	18.8	25.1	28.3
6.00	0.180	22.4	29.8	33.6
6.50	0.211	26.3	35.0	39.5
7.00	0.245	30.5	40.6	45.8
7.50	0.281	35.0	46.6	52.6
8.00	0.320	39.9	53.1	59.8
8.50	0.361	45.0	59.9	67.5
9.00	0.405	50.5	67.1	75.7
9.50	0.451	56.2	74.8	84.3
10.00	0.500	62.3	82.9	93.5
10.50	0.551	68.7	91.4	103.0
11.00	0.605	75.4	100.3	113.1
11.50	0.661	82.4	109.6	123.6
12.00	0.720	89.7	119.4	134.6
12.50	0.781	97.4	129.5	146.0
13.00	0.845	105.3	140.1	157.9
13.50	0.911	113.5	151.1	170.3
14.00	0.980	122.1	162.5	183.2
14.50	1.051	131.0	174.3	196.5
15.00	1.125	140.2	186.5	210.3
15.50	1.201	149.7	199.2	224.5
16.00	1.280	159.5	212.2	239.2
16.50	1.361	169.6	225.7	254.4
17.00	1.445	180.1	239.6	270.1
17.50	1.531	190.8	253.9	286.2
18.00	1.620	201.9	268.6	302.8

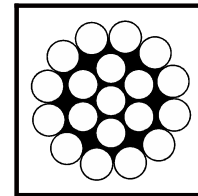

1X19=1X(1+6+12)

EN12385-10
JUS C.H1.061
DIN 3053



Steel Wire Ropes/Single Stranded Ropes

Prečnik užeta Rope Dia. mm	Težina Unit Weight kg/m	Wire Tensile		
		1180 N/mm ²	1570 N/mm ²	1770 N/mm ²
		Calculated Breaking Load kN		
3.00	0.044	5.4	7.2	8.2
3.50	0.061	7.4	9.9	11.1
4.00	0.080	9.7	12.9	14.5
4.50	0.101	12.3	16.3	18.4
5.00	0.125	15.1	20.1	22.7
5.50	0.151	18.3	24.4	27.5
6.00	0.180	21.8	29.0	32.7
6.50	0.211	25.6	34.0	38.4
7.00	0.245	29.7	39.5	44.5
7.50	0.281	34.1	45.3	51.1
8.00	0.320	38.7	51.5	58.1
8.50	0.361	43.7	58.2	65.6
9.00	0.405	49.0	65.2	73.5
9.50	0.451	54.6	72.7	81.9
10.00	0.500	60.5	80.5	90.8
11.00	0.605	73.2	97.5	109.9
12.00	0.720	87.2	116.0	130.8
13.00	0.845	102.3	136.1	153.5
14.00	0.980	118.6	157.9	178.0
15.00	1.125	136.2	181.2	204.3
16.00	1.280	155.0	206.2	232.5
17.00	1.445	174.9	232.8	262.4
18.00	1.620	196.1	261.0	294.2
19.00	1.805	218.5	290.8	327.8
20.00	2.000	242.1	322.2	363.2
21.00	2.205	267.0	355.2	400.4
22.00	2.420	293.0	389.8	439.5
23.00	2.645	320.2	426.1	480.3
24.00	2.880	348.7	463.9	523.0

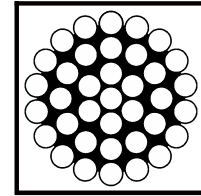

1X37=1X(1+6+12+18)

EN12385-10
JUS C.H1.062
DIN 3054



WIRE ROPE

Steel Wire Ropes

Prečnik užeta Rope Dia. mm	Težina Unit Weight kg/m	Zateznačvrstoča / Wire Tensile	
		1770 N/mm ²	1960 N/mm ²
		Minimalna prekidna sila (MBL) / kN	
8.00	0.221	37.6	41.6
9.00	0.279	47.6	52.7
10.00	0.345	58.8	65.1
11.00	0.417	71.1	78.7
12.00	0.497	84.6	93.7
13.00	0.583	99.3	110
14.00	0.676	115	128
15.00	0.776	132	146
16.00	0.883	150	167
17.00	0.997	170	188
18.00	1.118	190	211
19.00	1.245	212	235
20.00	1.38	235	260
22.00	1.73	284,4	315
24.00	2.06	338,5	374,8
30.00	3.16	528,8	585,6
32.00	3.66	602	666,3
36.00	4.63	761,5	843,3
46.00	7.21	1243,5	1376

NOTE: Larger diameters available upon request.

Prečnik užeta Rope Dia. mm	Težina Unit Weight kg/m	Zateznačvrstoča / Wire Tensile	
		1770 N/mm ²	1960 N/mm ²
		Minimalna prekidna sila (MBL) / kN	
8.00	0.246	40.7	45.0
9.00	0.311	51.5	57.0
10.00	0.384	63.5	70.4
11.00	0.465	76.9	85.1
12.00	0.553	91.5	101
13.00	0.649	107	119
14.00	0.753	125	138
15.00	0.864	143	158
16.00	0.983	163	180
17.00	1.110	184	203
18.00	1.244	206	228
19.00	1.386	229	254
20.00	1.536	254	281
22.00	1,9	307,5	340,5
24.00	2,27	366	405,3
30.00	3,45	571,8	633,2
32.00	4,03	650,6	720,5
36.00	5,09	823,5	912
46.00	7,45	1344,5	1488

NOTE: Larger diameters available upon request.

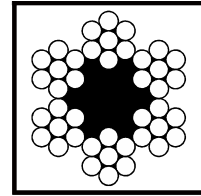

6X7=6X(1+6) FC
EN12385-4
JUS C.H1.070
DIN 3055

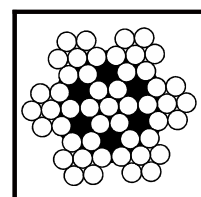

6X7=6X(1+6) IWRC
EN12385-4
JUS C.H1.070
DIN 3055

Steel Wire Ropes

Prečnik užeta Rope Dia. mm	Težina Unit Weight kg/m	Zateznačvrstoča / Wire Tensile	
		1770 N/mm ²	1960 N/mm ²
		Minimalna prekidna sila kN Minimum Breaking Load (MBL) / kN	
8.00	0.230	37.4	41.4
9.00	0.291	47.3	52.4
10.00	0.359	58.4	64.7
11.00	0.434	70.7	78.3
12.00	0.517	84.1	93.1
13.00	0.607	98.7	109.3
14.00	0.704	114	127
15.00	0.808	131	146
16.00	0.919	150	166
17.00	1.038	169	187
18.00	1.163	189	210
19.00	1.296	211	233
20.00	1.436	234	259
21.00	1.583	258	285
22.00	1.738	283	313
23.00	1.899	309	342
24.00	2.068	336	373
25.00	2.244	365	404
26.00	2.427	395	437

NOTE: Larger diameters available upon request.

Prečnik užeta Rope Dia. mm	Težina Unit Weight kg/m	Zateznačvrstoča / Wire Tensile	
		1770 N/mm ²	1960 N/mm ²
		Minimalna prekidna sila kN Minimum Breaking Load (MBL) / kN	
8.00	0.256	40.3	44.7
9.00	0.324	51.0	56.5
10.00	0.400	63.0	69.8
11.00	0.484	76.2	84.4
12.00	0.576	90.7	100.5
13.00	0.676	106.5	117.9
14.00	0.784	124	137
15.00	0.900	142	157
16.00	1.024	161	179
17.00	1.156	182	202
18.00	1.296	204	226
19.00	1.444	227	252
20.00	1.600	252	279
21.00	1.764	278	308
22.00	1.936	305	338
23.00	2.116	333	369
24.00	2.304	363	402
25.00	2.500	394	436
26.00	2.704	426	472

NOTE: Larger diameters available upon request.

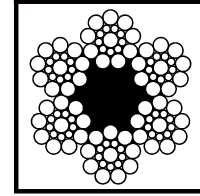

6X19 seale=6X(1+9+9) FC

EN12385-5
JUS C.H1.100
DIN 3063

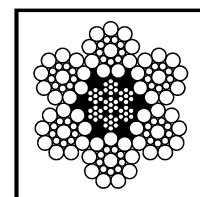

6X19 seale=6X(1+9+9) IWRC

EN12385-5
JUS C.H1.100
DIN 3063

WIRE ROPE

Steel Wire Ropes

Prečnik užeta Rope Dia. mm	Težina Unit Weight kg/m	Zateznačvrstoča / Wire Tensile	
		1770 N/mm ²	1960 N/mm ²
		Minimalna prekidna sila (MBL) / kN	
8.00	0.230	37.4	41.4
9.00	0.291	47.3	52.4
10.00	0.359	58.4	64.7
11.00	0.434	70.7	78.3
12.00	0.517	84.1	93.1
13.00	0.607	98.7	109.3
14.00	0.704	114	127
15.00	0.808	131	146
16.00	0.919	150	166.
17.00	1.038	169	187
18.00	1.163	189	210
19.00	1.296	211	233
20.00	1.436	234	259
21.00	1.583	258	285
22.00	1.738	283	313
23.00	1.899	309	342
24.00	2.068	336	373
25.00	2.244	365	404
26.00	2.427	395	437

NOTE: Larger diameters available upon request.

Prečnik užeta Rope Dia. mm	Težina Unit Weight kg/m	Zateznačvrstoča / Wire Tensile	
		1770 N/mm ²	1960 N/mm ²
		Minimalna prekidna sila (MBL) / kN	
8.00	0.256	40.3	44.7
9.00	0.324	51.0	56.5
10.00	0.400	63.0	69.8
11.00	0.484	76.2	84.4
12.00	0.576	90.7	100.5
13.00	0.676	106.5	117.9
14.00	0.784	124	137
15.00	0.900	142	157
16.00	1.024	161	179
17.00	1.156	182	202
18.00	1.296	204	226
19.00	1.444	227	252
20.00	1.600	252	279
21.00	1.764	278	308
22.00	1.936	305	338
23.00	2.116	333	369
24.00	2.304	363	402
25.00	2.500	394	436
26.00	2.704	426	472

NOTE: Larger diameters available upon request.

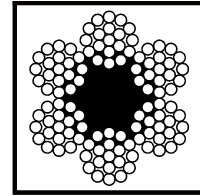

6X19 W=6X[1+6+(6+6)] FC

EN12385-4
JUS C.H1.090
DIN 3059

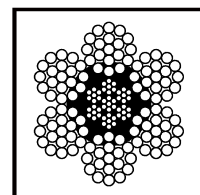

6X19 W=6X[1+6+(6+6)] IWRC

EN12385-4
JUS C.H1.090
DIN 3059

Steel Wire Ropes

Prečnik užeta Rope Dia. mm	Težina Unit Weight kg/m	Zateznačvrstoča / Wire Tensile	
		1770 N/mm ²	1960 N/mm ²
		Minimalna prekidna sila kN Minimum Breaking Load (MBL) / kN	
10.00	0.359	58.4	64.7
11.00	0.434	70.7	78.3
12.00	0.517	84.1	93.1
13.00	0.607	98.7	109.3
14.00	0.704	114	127
15.00	0.808	131	146
16.00	0.919	150	166
17.00	1.038	169	187
18.00	1.163	189	210
19.00	1.296	211	233
20.00	1.436	234	259
21.00	1.583	258	285
22.00	1.738	283	313
23.00	1.899	309	342
24.00	2.068	336	373
25.00	2.244	365	404
26.00	2.427	395	437

NOTE: Larger diameters available upon request.

Prečnik užeta Rope Dia. mm	Težina Unit Weight kg/m	Zateznačvrstoča / Wire Tensile	
		1770 N/mm ²	1960 N/mm ²
		Minimalna prekidna sila kN Minimum Breaking Load (MBL) / kN	
10.00	0.400	63.0	69.8
11.00	0.484	76.2	84.4
12.00	0.576	90.7	100.5
13.00	0.676	106.5	117.9
14.00	0.784	124	137
15.00	0.900	142	157
16.00	1.024	161	179
17.00	1.156	182	202
18.00	1.296	204	226
19.00	1.444	227	252
20.00	1.600	252	279
21.00	1.764	278	308
22.00	1.936	305	338
23.00	2.116	333	369
24.00	2.304	363	402
25.00	2.500	394	436
26.00	2.704	426	472

NOTE: Larger diameters available upon request.

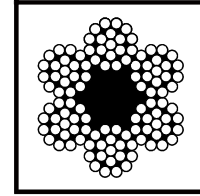

6X19 Filler=6X(1+6+6F+12) FC

EN12385
JUS C.H1.086
DIN 3057

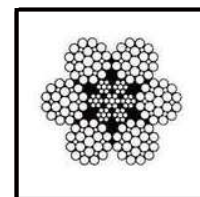

6X19 Filler=6X(1+6+6F+12) IWRC

EN12385
JUS C.H1.086
DIN 3057



WIRE ROPE

Steel Wire Ropes

Prečnik užeta Rope Dia. mm	Težina Unit Weight kg/m	Zatezna čvrstoća / Wire Tensile	
		1770 N/mm ²	1960 N/mm ²
		Minimalna prekidna sila kN Minimum Breaking Load (MBL) kN	
8.00	0.244	41.0	45.4
9.00	0.309	51.9	57.5
10.00	0.381	64.1	71.0
11.00	0.461	77.5	85.9
12.00	0.549	92.3	102.2
13.00	0.644	108	120
14.00	0.747	126	139
15.00	0.857	144	160
16.00	0.975	164	182
17.00	1.101	185	205
18.00	1.234	208	230
19.00	1.375	231	256
20.00	1.524	256	284
21.00	1.680	283	313
22.00	1.844	310	343
23.00	2.015	339	375
24.00	2.195	369	409
25.00	2.381	400	443
26.00	2.576	433	480
27.00	2.777	467	517
28.00	2.987	502	556
29.00	3.204	539	597
30.00	3.429	577	639
31.00	3.661	616	682
32.00	3.901	656	727
33.00	4.149	698	773
34.00	4.404	741	820
35.00	4.667	785	869
36.00	4.938	830	920
37.00	5.216	877	971
38.00	5.502	925	1025
39.00	5.795	975	1079
40.00	6.096	1025	1135
41.00	6.405	1077	1193
42.00	6.721	1130	1252
43.00	7.045	1185	1312
44.00	7.376	1240	1374
45.00	7.715	1297	1437
46.00	8.062	1356	1501
47.00	8.416	1415	1567
48.00	8.778	1476	1635

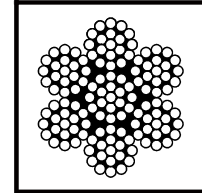

7X19 M=7X(1+6+12)

EN12385-4
JUS C.H1.031
DIN 3055



Steel Wire Ropes

Prečnik užeta Rope Dia. mm	Težina Unit Weight kg/m	Zateznačvrstoča / Wire Tensile	
		1770 N/mm ²	1960 N/mm ²
		Minimalna prekidna sila kN Minimum Breaking Load (MBL) / kN	
3.00	0.0311	4.89	5.42
4.00	0.0554	8.69	9.63
5.00	0.0865	13.6	15.0
6.00	0.125	19.6	21.7
8.00	0.221	34.8	38.5
9.00	0.280	44.0	48.7
10.00	0.346	54.3	60.2
11.00	0.419	65.8	72.8
12.00	0.498	78.2	86.6
13.00	0.585	91.8	101.7
14.00	0.678	107	118
15.00	0.779	122	135
16.00	0.886	139	154
17.00	1.000	157	174
18.00	1.121	176	195
19.00	1.249	196	217
20.00	1.384	217	241
21.00	1.526	240	265
22.00	1.675	263	291
23.00	1.830	287	318
24.00	1.993	313	347
25.00	2.163	340	376
26.00	2.339	367	407
27.00	2.522	396	439
28.00	2.713	426	472
29.00	2.910	457	506
30.00	3.114	489	542
31.00	3.325	522	578
32.00	3.543	556	616
33.00	3.768	592	655
34.00	4.000	628	696
35.00	4.239	666	737
36.00	4.484	704	780
37.00	4.737	744	824
38.00	4.996	785	869
39.00	5.263	826	915
40.00	5.536	869	963
41.00	5.816	913	
42.00	6.103	959	
43.00	6.398	1005	
44.00	6.699	1052	

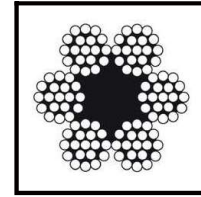

6X19 M=6X(1+6+12) FC

EN12385
JUS C.H1.072
DIN 3060



WIRE ROPE

Steel Wire Ropes

Prečnik užeta Rope Dia. mm	Težina Unit Weight kg/m	Zateznačvrstoča / Wire Tensile	
		1770 N/mm ²	1960 N/mm ²
		Minimalna prekidna sila kN Minimum Breaking Load (MBL) / kN	
3.00	0.0343	5.77	6.39
4.00	0.061	10.3	11.4
5.00	0.0953	16.0	17.7
6.00	0.137	23.1	25.5
8.00	0.244	37.6	41.6
9.00	0.309	47.6	52.7
10.00	0.381	58.8	65.1
11.00	0.461	71.1	78.7
12.00	0.549	84.6	93.7
13.00	0.644	99.3	110.0
14.00	0.747	115	128
15.00	0.857	132	146
16.00	0.975	150	167
17.00	1.101	170	188
18.00	1.234	190	211
19.00	1.375	212	235
20.00	1.524	235	260
21.00	1.680	259	287
22.00	1.844	284	315
23.00	2.015	311	344
24.00	2.195	338	375
25.00	2.381	367	407
26.00	2.576	397	440
27.00	2.777	428	474
28.00	2.987	461	510
29.00	3.204	494	547
30.00	3.429	529	586
31.00	3.661	565	625
32.00	3.901	602	666
33.00	4.149	640	709
34.00	4.404	679	752
35.00	4.667	720	797
36.00	4.938	762	843
37.00	5.216	804	891
38.00	5.502	849	940
39.00	5.795	894	990
40.00	6.096	940	1041
41.00	6.405	988	
42.00	6.721	1037	
43.00	7.045	1087	
44.00	7.376	1138	

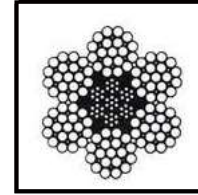

6X19 M=6X(1+6+12) IWRC

EN12385
JUS C.H1.072
DIN 3060

Steel Wire Ropes

Prečnik užeta Rope Dia. mm	Težina Unit Weight kg/m	Zatezna čvrstoća / Wire Tensile	
		1770 N/mm ²	1960 N/mm ²
		Minimalna prekidna sila kN Minimum Breaking Load (MBL) kN	
8.00	0.262	40.3	44.7
9.00	0.331	51.0	56.5
10.00	0.409	63.0	69.8
11.00	0.495	76.2	84.4
12.00	0.589	90.7	100.5
13.00	0.691	106.5	117.9
14.00	0.802	124	137
15.00	0.920	142	157
16.00	1.047	161	179
17.00	1.182	182	202
18.00	1.325	204	226
19.00	1.476	227	252
20.00	1.636	252	279
21.00	1.804	278	308
22.00	1.980	305	338
23.00	2.164	333	369
24.00	2.356	363	402

NOTE: Larger diameters available upon request.

Prečnik užeta Rope Dia. mm	Težina Unit Weight kg/m	Zatezna čvrstoća / Wire Tensile
		1960 N/mm ²
		Minimalna prekidna sila kN Minimum Breaking Load (MBL) kN
9.00	0.470	79
10.00	0.569	97
11.00	0.690	121
12.00	0.810	139
13.00	0.960	163
14.00	1.110	189
15.00	1.270	217
16.00	1.450	248
18.00	1.840	310

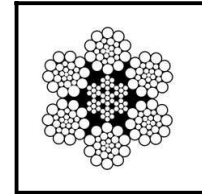

6X26 WS=6X[1+5+(5+5)+10] IWRC

EN12385-4
JUS C.H1.108
DIN 3064

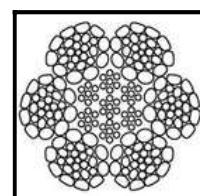

6X26 WS - PRESSED - IWRC

EN12385-4
JUS C.H1.108
DIN 3064

WIRE ROPE

Steel Wire Ropes

Prečnik užeta Rope Dia. mm	Težina Unit Weight kg/m	Zatezna čvrstoća / Wire Tensile	
		1770 N/mm ²	1960 N/mm ²
		Minimalna prekidna sila kN Minimum Breaking Load (MBL) kN	
8.00	0.235	37.4	41.4
9.00	0.297	47.3	52.4
10.00	0.367	58.4	64.7
11.00	0.444	70.7	78.3
12.00	0.528	84.1	93.1
13.00	0.620	98.7	109.3
14.00	0.719	114	127
15.00	0.826	131	146
16.00	0.940	150	166
17.00	1.061	169	187
18.00	1.189	189	210
19.00	1.325	211	233
20.00	1.468	234	259
21.00	1.618	258	285
22.00	1.776	283	313
23.00	1.941	309	342
24.00	2.114	336	373
25.00	2.294	365	404
26.00	2.481	395	437
27.00	2.675	426	472
28.00	2.877	458	507
29.00	3.086	491	544
30.00	3.303	526	582
31.00	3.527	561	622
32.00	3.758	598	662
33.00	3.997	636	704
34.00	4.243	675	748
35.00	4.496	716	792
36.00	4.756	757	838
37.00	5.024	800	885
38.00	5.299	843	934
39.00	5.582	888	984
40.00	5.872	935	1035
41.00	6.169	982	1087
42.00	6.474	1030	1141
43.00	6.786	1080	1196
44.00	7.105	1131	1252
46.00	7.766	1236	1369
48.00	8.456	1346	
50.00	9.175	1460	
52.00	9.924	1579	

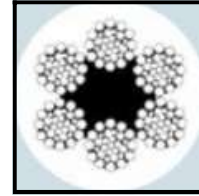

6X31 WS=6X[1+6+(6+6)+12] FC

EN12385-4
JUS C.H1.106
DIN 3061



Steel Wire Ropes

Prečnik užeta Rope Dia. mm	Težina Unit Weight kg/m	Zatezna čvrstoća / Wire Tensile	
		1770 N/mm ²	1960 N/mm ²
		Minimalna prekidna sila kN Minimum Breaking Load (MBL) kN	
8.00	0.262	40.3	44.7
9.00	0.331	51.0	56.5
10.00	0.409	63.0	69.8
11.00	0.495	76.2	84.4
12.00	0.589	90.7	100.5
13.00	0.691	106.5	117.9
14.00	0.802	124	137
15.00	0.920	142	157
16.00	1.047	161	179
17.00	1.182	182	202
18.00	1.325	204	226
19.00	1.476	227	252
20.00	1.636	252	279
21.00	1.804	278	308
22.00	1.980	305	338
23.00	2.164	333	369
24.00	2.356	363	402
25.00	2.556	394	436
26.00	2.765	426	472
27.00	2.982	459	509
28.00	3.207	494	547
29.00	3.440	530	587
30.00	3.681	567	628
31.00	3.930	606	671
32.00	4.188	645	715
33.00	4.454	686	760
34.00	4.728	728	807
35.00	5.010	772	855
36.00	5.301	817	904
37.00	5.599	863	955
38.00	5.906	910	1008
39.00	6.221	958	1061
40.00	6.544	1008	1116
41.00	6.875	1059	1173
42.00	7.215	1112	1231
43.00	7.562	1165	1290
44.00	7.918	1220	1351
46.00	8.654	1333	1476
48.00	9.423	1452	
50.00	10.225	1575	
52.00	11.059	1704	

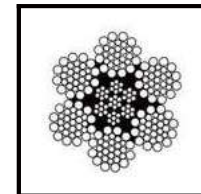
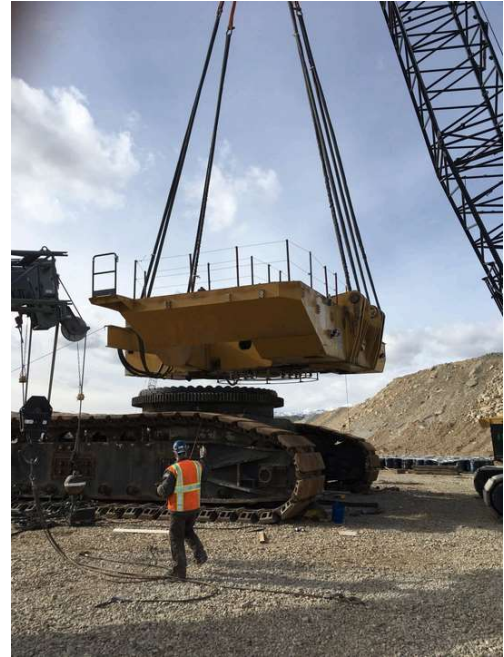

6X31 WS=6X[1+6+(6+6)+12] IWRC

EN12385-4
JUS C.H1.106
DIN 3061



WIRE ROPE

Steel Wire Ropes

Prečnik užeta Rope Dia. mm	Težina Unit Weight kg/m	Zatezna čvrstoća / Wire Tensile	
		1770 N/mm ²	1960 N/mm ²
		Minimalna prekidna sila kN Minimum Breaking Load (MBL) kN	
8.00	0.235	37.4	41.4
9.00	0.297	47.3	52.4
10.00	0.367	58.4	64.7
11.00	0.444	70.7	78.3
12.00	0.528	84.1	93.1
13.00	0.620	98.7	109.3
14.00	0.719	114	127
15.00	0.826	131	146
16.00	0.940	150	166
17.00	1.061	169	187
18.00	1.189	189	210
19.00	1.325	211	233
20.00	1.468	234	259
21.00	1.618	258	285
22.00	1.776	283	313
23.00	1.941	309	342
24.00	2.114	336	373
25.00	2.294	365	404
26.00	2.481	395	437
27.00	2.675	426	472
28.00	2.877	458	507
29.00	3.086	491	544
30.00	3.303	526	582
31.00	3.527	561	622
32.00	3.758	598	662
33.00	3.997	636	704
34.00	4.243	675	748
35.00	4.496	716	792
36.00	4.756	757	838
37.00	5.024	800	885
38.00	5.299	843	934
39.00	5.582	888	984
40.00	5.872	935	1035
41.00	6.169	982	1087
42.00	6.474	1030	1141
43.00	6.786	1080	1196
44.00	7.105	1131	1252
46.00	7.766	1236	1369
48.00	8.456	1346	1490
50.00	9.175	1460	1617
52.00	9.924	1579	1749
54.00	10.702	1703	
56.00	11.509	1832	
58.00	12.346	1965	

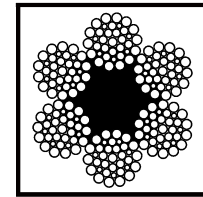

6X36 WS=6X[1+7+(7+7)+14] FC

EN12385-4
JUS C.H1.108
DIN 3064



Steel Wire Ropes

Prečnik užeta Rope Dia. mm	Težina Unit Weight kg/m	Zatezna čvrstoća / Wire Tensile	
		1770 N/mm ²	1960 N/mm ²
		Minimalna prekidna sila kN Minimum Breaking Load (MBL) kN	
8.00	0.262	40.3	44.7
9.00	0.331	51.0	56.5
10.00	0.409	63.0	69.8
11.00	0.495	76.2	84.4
12.00	0.589	90.7	100.5
13.00	0.691	106.5	117.9
14.00	0.802	124	137
15.00	0.920	142	157
16.00	1.047	161	179
17.00	1.182	182	202
18.00	1.325	204	226
19.00	1.476	227	252
20.00	1.636	252	279
21.00	1.804	278	308
22.00	1.980	305	338
23.00	2.164	333	369
24.00	2.356	363	402
25.00	2.556	394	436
26.00	2.765	426	472
27.00	2.982	459	509
28.00	3.207	494	547
29.00	3.440	530	587
30.00	3.681	567	628
31.00	3.930	606	671
32.00	4.188	645	715
33.00	4.454	686	760
34.00	4.728	728	807
35.00	5.010	772	855
36.00	5.301	817	904
37.00	5.599	863	955
38.00	5.906	910	1008
39.00	6.221	958	1061
40.00	6.544	1008	1116
41.00	6.875	1059	1173
42.00	7.215	1112	1231
43.00	7.562	1165	1290
44.00	7.918	1220	1351
46.00	8.654	1333	1476
48.00	9.423	1452	1608
50.00	10.225	1575	1744
52.00	11.059	1704	1887
54.00	11.926	1837	
56.00	12.826	1976	
58.00	13.759	2120	

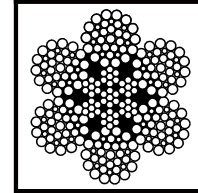

6X36 WS=6X[1+7+(7+7)+14] IWRC

EN12385-4
JUS C.H1.108
DIN 3064



WIRE ROPE

Steel Wire Ropes

Prečnik užeta Rope Dia. mm	Težina Unit Weight kg/m	Zatezna čvrstoća / Wire Tensile	
		1770 N/mm ²	1960 N/mm ²
		Minimalna prekidna sila (MBL) / kN	
6.00	0.125	18.8	20.8
8.00	0.221	33.4	37.0
9.00	0.280	42.3	46.8
10.00	0.346	52.2	57.8
11.00	0.419	63.2	70.0
12.00	0.498	75.2	83.3
13.00	0.585	88.2	97.7
14.00	0.678	102.3	113.3
15.00	0.779	117	130
16.00	0.886	134	148
17.00	1.000	151	167
18.00	1.121	169	187
19.00	1.249	188	209
20.00	1.384	209	231
21.00	1.526	230	255
22.00	1.675	253	280
23.00	1.830	276	306
24.00	1.993	301	333
25.00	2.163	326	361
26.00	2.339	353	391
27.00	2.522	381	422
28.00	2.713	409	453
29.00	2.910	439	486
30.00	3.114	470	520
31.00	3.325	502	556
32.00	3.543	535	592
33.00	3.768	569	630
34.00	4.000	604	668
35.00	4.239	640	708
36.00	4.484	677	749
37.00	4.737	715	792
38.00	4.996	754	835
39.00	5.263	794	879
40.00	5.536	835	925
41.00	5.816	878	972
42.00	6.103	921	1020
43.00	6.398	965	1069
44.00	6.699	1011	1119
45.00	7.007	1057	1171
46.00	7.321	1105	1223
47.00	7.643	1153	1277
48.00	7.972	1203	1332
49.00	8.307	1254	1388
50.00	8.650	1305	1446
51.00	8.999	1358	1504
52.00	9.356	1412	1563
53.00	9.719	1467	1624
54.00	10.089	1523	1686
55.00	10.467	1580	1749
56.00	10.851	1637	1813
57.00	11.242	1696	1879
58.00	11.639	1757	1945
59.00	12.044	1818	2013
60.00	12.456	1880	2082
61.00	12.875	1943	
62.00	13.300	2007	
63.00	13.733	2072	
64.00	14.172	2139	
65.00	14.619	2206	
66.00	15.072	2274	

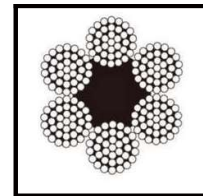
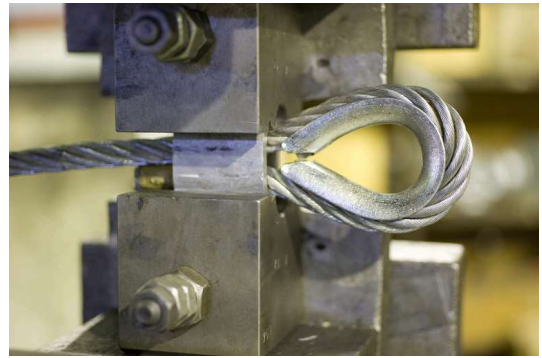

6X37 M=6X[1+6+12]+18] FC

EN12385-4
JUS C.H1.074
DIN 3066



Steel Wire Ropes

Prečnik užeta Rope Dia. mm	Težina Unit Weight kg/m	Zatezna čvrstoća / Wire Tensile	
		1770 N/mm ²	1960 N/mm ²
Minimalna prekidna sila (MBL) / kN			
6.00	0.137	20.3	22.0
8.00	0.244	36.1	40.0
9.00	0.309	45.7	50.6
10.00	0.381	56.5	62.5
11.00	0.461	68.3	75.7
12.00	0.549	81.3	90.0
13.00	0.644	95.4	105.7
14.00	0.747	110.7	122.5
15.00	0.857	127.0	140.7
16.00	0.975	144.5	160.1
17.00	1.101	163.2	180.7
18.00	1.234	182.9	202.6
19.00	1.375	203.8	225.7
20.00	1.524	225.9	250.1
21.00	1.680	249.0	275.7
22.00	1.844	273.3	302.6
23.00	2.015	298.7	330.8
24.00	2.195	325.2	360.1
25.00	2.381	352.9	390.8
26.00	2.576	381.7	422.7
27.00	2.777	411.6	455.8
28.00	2.987	442.7	490.2
29.00	3.204	474.9	525.8
30.00	3.429	508.2	562.7
31.00	3.661	542.6	600.9
32.00	3.901	578.2	640.2
33.00	4.149	614.9	680.9
34.00	4.404	652.7	722.8
35.00	4.667	691.7	765.9
36.00	4.938	731.8	810.3
37.00	5.216	773.0	856.0
38.00	5.502	815.3	902.8
39.00	5.795	858.8	951.0
40.00	6.096	903.4	1000.4
41.00	6.405	949.1	1051.0
42.00	6.721	996.0	1102.9
43.00	7.045	1044.0	1156.1
44.00	7.376	1093.1	1210.5
45.00	7.715	1143.4	1266.1
46.00	8.062	1194.8	1323.0
47.00	8.416	1247.3	1381.2
48.00	8.778	1300.9	1440.6
49.00	9.148	1355.7	1501.2
50.00	9.525	1411.6	1563.1
51.00	9.910	1468.6	1626.2
52.00	10.302	1526.8	1690.6
53.00	10.702	1586.0	1756.3
54.00	11.110	1646.5	1823.2
55.00	11.525	1708.0	1891.4
56.00	11.948	1770.7	1960.8
57.00	12.379	1834.5	2031.4
58.00	12.817	1899.4	2103.3
59.00	13.263	1965.5	2176.5
60.00	13.716	2032.7	2250.9
61.00	14.177	2101.0	
62.00	14.646	2170.4	
63.00	15.122	2241.0	
64.00	15.606	2312.7	
65.00	16.097	2385.6	
66.00	16.596	2459.5	

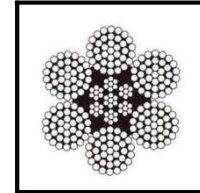

6X37 M=6X[1+6+12]+18] IWRC

EN12385-4
JUS C.H1.074
DIN 3066



WIRE ROPE

Steel Wire Ropes

Prečnik užeta Rope Dia.mm	Težina Unit Weight kg/m	Zatezna čvrstoća / Wire Tensile		
		1570 N/mm ²	1770 N/mm ²	1960 N/mm ²
		Računska prekidana sila kN Minimum Breakig Load (MBL) kN		
10	0.391	61.6	69.6	77
11	0.473	74.6	84.1	93.1
12	0.563	88.8	100.1	110.8
13	0.643	104.2	117.5	130.1
14	0.745	120.9	136.2	150.9
15	0.859	139	156	173
16	0.973	158	178	197
17	1.066	178	201	222
18	1.232	200	225	249
19	1.343	223	251	278
20	1.52	247	278	308
22	1.84	289	336	372
24	2.19	335	400	443
26	2.57	417	470	520
28	2.99	483	545	603
30	3.42	555	625	693
32	3.89	631	712	788
34	4.39	713	803	890
36	4.93	799	901	997
38	5.49	890	1004	1111
40	6.08	986	1112	1231
42	6.71	1087	1226	1357
44	7.36	1194	1346	1489
46	8.05	1305	1471	1628
48	8.76	1420	1602	1722
50	9.5	1541	1738	1923
52	10.3	1667	1879	2080
54	11.1	1798	2027	2243
56	11.9	1934	2180	2412
58	12.8	2074	2338	2588

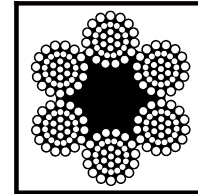

6X37S=6X[7+15+15]+VJ

EN12385
JUS C.H1.0102

Prečnik užeta Rope Dia.mm	Težina Unit Weight kg/m	Zatezna čvrstoća / Wire Tensile		
		1570 N/mm ²	1770 N/mm ²	1960 N/mm ²
		Računska prekidana sila kN Minimum Breakig Load (MBL) kN		
10	0.43	71.5	80.6	89.3
11	0.523	86.6	97.5	108
12	0.625	102.9	116.1	128.6
13	0.707	120.9	136.3	150.9
14	0.82	140.2	158	175
15	0.935	161	181	201
16	1.071	183	206	228
17	1.154	207	233	258
18	1.355	235	261	289
19	1.459	258	291	322
20	1.67	286	323	357
22	2.02	346	390	432
24	2.41	412	464	514
26	2.83	484	545	603
28	3.22	561	632	670
30	3.76	644	726	803
32	4.28	732	826	914
34	4.84	827	932	1032
36	5.42	927	1045	1156
38	6.04	1033	1164	1289
40	6.69	1146	1290	1428
42	7.38	1262	1422	1574
44	8.1	1358	1561	1728
46	8.85	1513	1706	1888
48	9.64	1648	1858	2056
50	10.5	1788	2016	2231
52	11.3	1933	2179	2413
54	12.2	2086	2351	2602
56	13.1	2243	2529	2798
58	14.1	2406	2712	3002

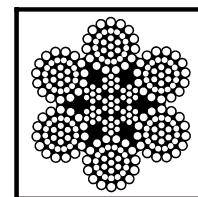

6X37S=6X[7+15+15]+ČJ

EN12385
JUS C.H1.0102

Steel Wire Ropes

Prečnik užeta Rope Dia. mm	Težina Unit Weight kg/m	Zatezna čvrstoća / Wire Tensile	
		1770 N/mm ²	1960 N/mm ²
		Minimalna prekidna sila kN Minimum Breaking Load (MBL) kN	
18.00	1.189	189	210
19.00	1.325	211	233
20.00	1.468	234	259
21.00	1.618	258	285
22.00	1.776	283	313
23.00	1.941	309	342
24.00	2.114	336	373
25.00	2.294	365	404
26.00	2.481	395	437
27.00	2.675	426	472
28.00	2.877	458	507
29.00	3.086	491	544
30.00	3.303	526	582
31.00	3.527	561	622
32.00	3.758	598	662
33.00	3.997	636	704
34.00	4.243	675	748
35.00	4.496	716	792
36.00	4.756	757	838
37.00	5.024	800	885
38.00	5.299	843	934
39.00	5.582	888	984
40.00	5.872	935	1035
41.00	6.169	982	1087
42.00	6.474	1030	1141
43.00	6.786	1080	1196
44.00	7.105	1131	1252
46.00	7.766	1236	1369
48.00	8.456	1346	1490
50.00	9.175	1460	1617
52.00	9.924	1579	1749
54.00	10.702	1703	1886
56.00	11.509	1832	2028
58.00	12.346	1965	
60.00	13.212	2103	
62.00	14.107	2245	

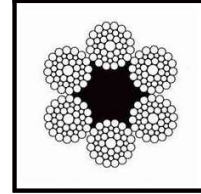

6X41 WS=6X[1+8+(8+8)+16] FC
EN12385-4



WIRE ROPE

Steel Wire Ropes

Prečnik užeta Rope Dia. mm	Težina Unit Weight kg/m	Zatezna čvrstoća / Wire Tensile	
		1770 N/mm ²	1960 N/mm ²
		Minimalna prekidna sila kN Minimum Breaking Load (MBL) kN	
18.00	1.325	204	226
19.00	1.476	227	252
20.00	1.636	252	279
21.00	1.804	278	308
22.00	1.980	305	338
23.00	2.164	333	369
24.00	2.356	363	402
25.00	2.556	394	436
26.00	2.765	426	472
27.00	2.982	459	509
28.00	3.207	494	547
29.00	3.440	530	587
30.00	3.681	567	628
31.00	3.930	606	671
32.00	4.188	645	715
33.00	4.454	686	760
34.00	4.728	728	807
35.00	5.010	772	855
36.00	5.301	817	904
37.00	5.599	863	955
38.00	5.906	910	1008
39.00	6.221	958	1061
40.00	6.544	1008	1116
41.00	6.875	1059	1173
42.00	7.215	1112	1231
43.00	7.562	1165	1290
44.00	7.918	1220	1351
46.00	8.654	1333	1476
48.00	9.423	1452	1608
50.00	10.225	1575	1744
52.00	11.059	1704	1887
54.00	11.926	1837	2035
56.00	12.826	1976	2188
58.00	13.759	2120	
60.00	14.724	2268	
62.00	15.722	2422	

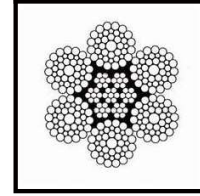

6X41 WS=6X[1+8+(8+8)+16] IWRC
EN12385-4



Steel Wire Ropes

Prečnik užeta Rope Dia. mm	Težina Unit Weight kg/m	Zatezna čvrstoća / Wire Tensile	
		1770 N/mm ²	1960 N/mm ²
		Minimalna prekidna sila kN Minimum Breaking Load (MBL) kN	
8.00	0.218	33.2	36.8
9.00	0.275	42.0	46.5
10.00	0.340	51.9	57.4
11.00	0.411	62.8	69.5
12.00	0.490	74.7	82.7
13.00	0.575	87.6	97.1
14.00	0.666	101.6	112.6
15.00	0.765	117	129
16.00	0.870	133	147
17.00	0.983	150	166
18.00	1.102	168	186
19.00	1.227	187	207
20.00	1.360	207	230
21.00	1.499	229	253
22.00	1.646	251	278
23.00	1.799	274	304
24.00	1.958	299	331

NOTE: Larger diameters available upon request.

Prečnik užeta Rope Dia. mm	Težina Unit Weight kg/m	Zatezna čvrstoća / Wire Tensile	
		1770 N/mm ²	1960 N/mm ²
		Minimalna prekidna sila kN Minimum Breaking Load (MBL) kN	
8.00	0.260	40.3	44.7
9.00	0.330	51.0	56.5
10.00	0.407	63.0	69.8
11.00	0.492	76.2	84.4
12.00	0.586	90.7	100.5
13.00	0.688	106	118
14.00	0.798	124	137
15.00	0.916	142	157
16.00	1.042	161	179
17.00	1.176	182	202
18.00	1.319	204	226
19.00	1.469	227	252
20.00	1.628	252	279
21.00	1.795	278	308
22.00	1.970	305	338
23.00	2.153	333	369
24.00	2.344	363	402

NOTE: Larger diameters available upon request.

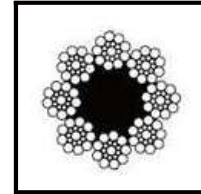

8X19 Seale=8X(1+9+9) FC
EN12385-5
JUS C.H1.104
DIN 3062

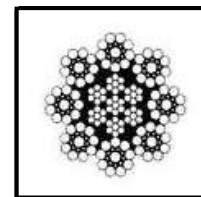

8X19 Seale=8X(1+9+9) IWRC
EN12385-5
JUS C.H1.104
DIN 3062

WIRE ROPE

Steel Wire Ropes

Prečnik užeta Rope Dia. mm	Težina Unit Weight kg/m	Zatezna čvrstoća / Wire Tensile	
		1770 N/mm ²	1960 N/mm ²
		Minimalna prekidna sila kN Minimum Breaking Load (MBL) kN	
8.00	0.218	33.2	36.8
9.00	0.275	42.0	46.5
10.00	0.340	51.9	57.4
11.00	0.411	62.8	69.5
12.00	0.490	74.7	82.7
13.00	0.575	87.6	97.1
14.00	0.666	101.6	112.6
15.00	0.765	117	129
16.00	0.870	133	147
17.00	0.983	150	166
18.00	1.102	168	186
19.00	1.227	187	207
20.00	1.360	207	230
21.00	1.499	229	253
22.00	1.646	251	278
23.00	1.799	274	304
24.00	1.958	299	331

NOTE: Larger diameters available upon request.

Prečnik užeta Rope Dia. mm	Težina Unit Weight kg/m	Zatezna čvrstoća / Wire Tensile	
		1770 N/mm ²	1960 N/mm ²
		Minimalna prekidna sila kN Minimum Breaking Load (MBL) kN	
8.00	0.260	40.3	44.7
9.00	0.330	51.0	56.5
10.00	0.407	63.0	69.8
11.00	0.492	76.2	84.4
12.00	0.586	90.7	100.5
13.00	0.688	106	118
14.00	0.798	124	137
15.00	0.916	142	157
16.00	1.042	161	179
17.00	1.176	182	202
18.00	1.319	204	226
19.00	1.469	227	252
20.00	1.628	252	279
21.00	1.795	278	308
22.00	1.970	305	338
23.00	2.153	333	369
24.00	2.344	363	402

NOTE: Larger diameters available upon request.

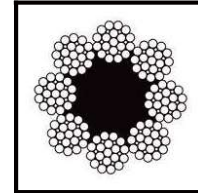

8X19 W=8X[1+6+(6+6)] FC

EN12385
JUS C.H1.096
DIN 3063

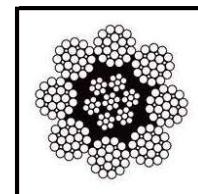

8X19 W=8X[1+6+(6+6)] IWRC

EN12385
JUS C.H1.096
DIN 3063

Steel Wire Ropes

Prečnik užeta Rope Dia. mm	Težina Unit Weight kg/m	Zatezna čvrstoća / Wire Tensile	
		1770 N/mm ²	1960 N/mm ²
		Minimalna prekidna sila kN Minimum Breaking Load (MBL) kN	
8.00	0.218	33.2	36.8
9.00	0.275	42.0	46.5
10.00	0.340	51.9	57.4
11.00	0.411	62.8	69.5
12.00	0.490	74.7	82.7
13.00	0.575	87.6	97.1
14.00	0.666	102	113
15.00	0.765	117	129
16.00	0.870	133	147
17.00	0.983	150	166
18.00	1.102	168	186
19.00	1.227	187	207
20.00	1.360	207	230
21.00	1.499	229	253
22.00	1.646	251	278
23.00	1.799	274	304
24.00	1.958	299	331
25.00	2.125	324	359
26.00	2.298	351	388
27.00	2.479	378	419
28.00	2.666	407	450
29.00	2.859	436	483
30.00	3.060	467	517
31.00	3.267	498	552
32.00	3.482	531	588
33.00	3.703	565	625
34.00	3.930	600	664
35.00	4.165	635	703
36.00	4.406	672	744
37.00	4.655	710	786
38.00	4.910	749	829
39.00	5.171	789	873
40.00	5.440	830	919
41.00	5.715	872	965
42.00	5.998	915	1013
43.00	6.287	959	1062
44.00	6.582	1004	1112
45.00	6.885	1050	1163
46.00	7.194	1097	1215
47.00	7.511	1146	1269
48.00	7.834	1195	1323

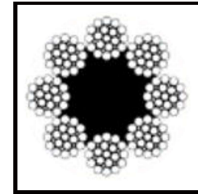

8x19 Filler = 8x(1+6+6F+12)FC / VJ

EN12385
JUS C.H1.088
DIN 3061

WIRE ROPE

Steel Wire Ropes

Prečnik užeta Rope Dia. mm	Težina Unit Weight kg/m	Zatezna čvrstoća / Wire Tensile	
		1770 N/mm ²	1960 N/mm ²
		Minimalna prekidna sila kN Minimum Breaking Load (MBL) kN	
8.00	0.260	40.3	44.7
9.00	0.330	51.0	56.5
10.00	0.407	63.0	69.8
11.00	0.492	76.2	84.4
12.00	0.586	90.7	100.5
13.00	0.688	106.5	117.9
14.00	0.798	124	137
15.00	0.916	142	157
16.00	1.042	161	179
17.00	1.176	182	202
18.00	1.319	204	226
19.00	1.469	227	252
20.00	1.628	252	279
21.00	1.795	278	308
22.00	1.970	305	338
23.00	2.153	333	369
24.00	2.344	363	402
25.00	2.544	394	436
26.00	2.751	426	472
27.00	2.967	459	509
28.00	3.191	494	547
29.00	3.423	530	587
30.00	3.663	567	628
31.00	3.911	606	671
32.00	4.168	645	715
33.00	4.432	686	760
34.00	4.705	728	807
35.00	4.986	772	855
36.00	5.275	817	904
37.00	5.572	863	955
38.00	5.877	910	1008
39.00	6.190	958	1061
40.00	6.512	1008	1116
41.00	6.842	1059	1173
42.00	7.179	1112	1231
43.00	7.525	1165	1290
44.00	7.880	1220	1351
45.00	8.242	1276	1413
46.00	8.612	1333	1476
47.00	8.991	1392	1541
48.00	9.377	1452	1608

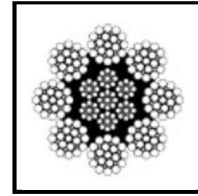

8x19 Filler = 8x(1+6+6F+12) IWRC / ČJ

EN12385
JUS C.H1.088
DIN 3061

Steel Wire Ropes

Prečnik užeta Rope Dia. mm	Težina Unit Weight kg/m	Zatezna čvrstoća / Wire Tensile	
		1770 N/mm ²	1960 N/mm ²
		Minimalna prekidna sila kN Minimum Breaking Load (MBL) kN	
10.00	0.356	51.9	57.4
11.00	0.431	62.8	69.5
12.00	0.513	74.7	82.7
13.00	0.602	87.6	97.1
14.00	0.698	101.6	112.6
15.00	0.801	117	129
16.00	0.911	133	147
17.00	1.029	150	166
18.00	1.153	168	186
19.00	1.285	187	207
20.00	1.424	207	230
21.00	1.570	229	253
22.00	1.723	251	278
23.00	1.883	274	304
24.00	2.051	299	331
25.00	2.225	324	359
26.00	2.407	351	388
27.00	2.595	378	419
28.00	2.791	407	450
29.00	2.994	436	483
30.00	3.204	467	517
31.00	3.421	498	552
32.00	3.645	531	588
33.00	3.877	565	625
34.00	4.115	600	664
35.00	4.361	635	703
36.00	4.614	672	744
37.00	4.874	710	786
38.00	5.141	749	829
39.00	5.415	789	873
40.00	5.696	830	919
41.00	5.984	872	965
42.00	6.280	915	1013
43.00	6.582	959	1062
44.00	6.892	1004	1112
46.00	7.533	1097	1215
48.00	8.202	1195	1323
50.00	8.900	1297	1436
52.00	9.626	1402	1553
54.00	10.381	1512	1675
56.00	11.164	1626	1801
58.00	11.976	1745	1932
60.00	12.816	1867	2067

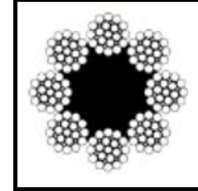

8x21 Filler = 8(1+5+5+10)FC / VJ
EN12385

WIRE ROPE

Steel Wire Ropes

Prečnik užeta Rope Dia. mm	Težina Unit Weight kg/m	Zatezna čvrstoća / Wire Tensile	
		1770 N/mm ²	1960 N/mm ²
		Minimalna prekidna sila kN Minimum Breaking Load (MBL) kN	
10.00	0.435	63.0	69.8
11.00	0.526	76.2	84.4
12.00	0.626	90.7	100.5
13.00	0.735	106.5	117.9
14.00	0.853	124	137
15.00	0.979	142	157
16.00	1.114	161	179
17.00	1.257	182	202
18.00	1.409	204	226
19.00	1.570	227	252
20.00	1.740	252	279
21.00	1.918	278	308
22.00	2.105	305	338
23.00	2.301	333	369
24.00	2.506	363	402
25.00	2.719	394	436
26.00	2.941	426	472
27.00	3.171	459	509
28.00	3.410	494	547
29.00	3.658	530	587
30.00	3.915	567	628
31.00	4.180	606	671
32.00	4.454	645	715
33.00	4.737	686	760
34.00	5.029	728	807
35.00	5.329	772	855
36.00	5.638	817	904
37.00	5.955	863	955
38.00	6.281	910	1008
39.00	6.616	958	1061
40.00	6.960	1008	1116
41.00	7.312	1059	1173
42.00	7.673	1112	1231
43.00	8.043	1165	1290
44.00	8.422	1220	1351
46.00	9.205	1333	1476
48.00	10.022	1452	1608
50.00	10.875	1575	1744
52.00	11.762	1704	1887
54.00	12.685	1837	2035
56.00	13.642	1976	2188
58.00	14.633	2120	2347
60.00	15.660	2268	2512

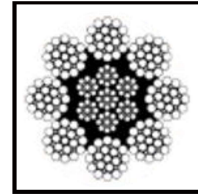

8x21 Filler = 8(1+5+5+10)IWRC / ČJ

EN12385

Steel Wire Ropes

Prečnik užeta Rope Dia. mm	Težina Unit Weight kg/m	Zatezna čvrstoća / Wire Tensile	
		1770 N/mm ²	1960 N/mm ²
		Minimalna prekidna sila kN Minimum Breaking Load (MBL) kN	
10.00	0.356	51.9	57.4
11.00	0.431	62.8	69.5
12.00	0.513	74.7	82.7
13.00	0.602	87.6	97.1
14.00	0.698	101.6	112.6
15.00	0.801	117	129
16.00	0.911	133	147
17.00	1.029	150	166
18.00	1.153	168	186
19.00	1.285	187	207
20.00	1.424	207	230
21.00	1.570	229	253
22.00	1.723	251	278
23.00	1.883	274	304
24.00	2.051	299	331
25.00	2.225	324	359
26.00	2.407	351	388
27.00	2.595	378	419
28.00	2.791	407	450
29.00	2.994	436	483
30.00	3.204	467	517
31.00	3.421	498	552
32.00	3.645	531	588
33.00	3.877	565	625
34.00	4.115	600	664
35.00	4.361	635	703
36.00	4.614	672	744
37.00	4.874	710	786
38.00	5.141	749	829
39.00	5.415	789	873
40.00	5.696	830	919
41.00	5.984	872	965
42.00	6.280	915	1013
43.00	6.582	959	1062
44.00	6.892	1004	1112
46.00	7.533	1097	1215
48.00	8.202	1195	1323
50.00	8.900	1297	1436
52.00	9.626	1402	1553
54.00	10.381	1512	1675
56.00	11.164	1626	1801
58.00	11.976	1745	1932
60.00	12.816	1867	2067

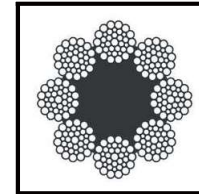

8X26 WS=8X[1+5+(5+5)+10] FC
EN12385

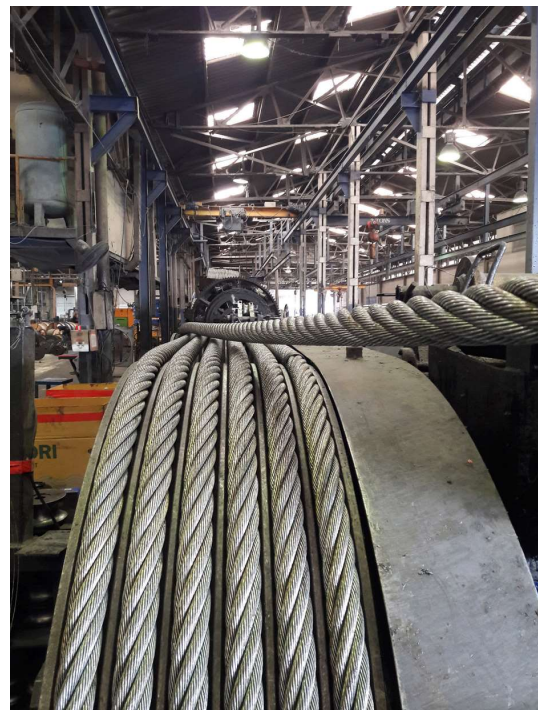

WIRE ROPE

Steel Wire Ropes

Prečnik užeta Rope Dia. mm	Težina Unit Weight kg/m	Zatezna čvrstoća / Wire Tensile	
		1770 N/mm ²	1960 N/mm ²
		Minimalna prekidna sila kN Minimum Breaking Load (MBL) kN	
10.00	0.435	63.0	69.8
11.00	0.526	76.2	84.4
12.00	0.626	90.7	100.5
13.00	0.735	106.5	117.9
14.00	0.853	124	137
15.00	0.979	142	157
16.00	1.114	161	179
17.00	1.257	182	202
18.00	1.409	204	226
19.00	1.570	227	252
20.00	1.740	252	279
21.00	1.918	278	308
22.00	2.105	305	338
23.00	2.301	333	369
24.00	2.506	363	402
25.00	2.719	394	436
26.00	2.941	426	472
27.00	3.171	459	509
28.00	3.410	494	547
29.00	3.658	530	587
30.00	3.915	567	628
31.00	4.180	606	671
32.00	4.454	645	715
33.00	4.737	686	760
34.00	5.029	728	807
35.00	5.329	772	855
36.00	5.638	817	904
37.00	5.955	863	955
38.00	6.281	910	1008
39.00	6.616	958	1061
40.00	6.960	1008	1116
41.00	7.312	1059	1173
42.00	7.673	1112	1231
43.00	8.043	1165	1290
44.00	8.422	1220	1351
46.00	9.205	1333	1476
48.00	10.022	1452	1608
50.00	10.875	1575	1744
52.00	11.762	1704	1887
54.00	12.685	1837	2035
56.00	13.642	1976	2188
58.00	14.633	2120	2347
60.00	15.660	2268	2512

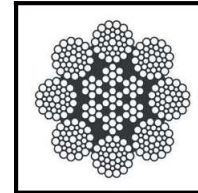

8X26 WS=8X[1+5+(5+5)+10] IWRC
EN12385



Steel Wire Ropes

Prečnik užeta Rope Dia. mm	Težina Unit Weight kg/m	Zatezna čvrstoća / Wire Tensile	
		1770 N/mm ²	1960 N/mm ²
		Minimalna prekidna sila kN Minimum Breaking Load (MBL) kN	
10.00	0.356	51.9	57.4
11.00	0.431	62.8	69.5
12.00	0.513	74.7	82.7
13.00	0.602	87.6	97.1
14.00	0.698	101.6	112.6
15.00	0.801	117	129
16.00	0.911	133	147
17.00	1.029	150	166
18.00	1.153	168	186
19.00	1.285	187	207
20.00	1.424	207	230
21.00	1.570	229	253
22.00	1.723	251	278
23.00	1.883	274	304
24.00	2.051	299	331
25.00	2.225	324	359
26.00	2.407	351	388
27.00	2.595	378	419
28.00	2.791	407	450
29.00	2.994	436	483
30.00	3.204	467	517
31.00	3.421	498	552
32.00	3.645	531	588
33.00	3.877	565	625
34.00	4.115	600	664
35.00	4.361	635	703
36.00	4.614	672	744
37.00	4.874	710	786
38.00	5.141	749	829
39.00	5.415	789	873
40.00	5.696	830	919
41.00	5.984	872	965
42.00	6.280	915	1013
43.00	6.582	959	1062
44.00	6.892	1004	1112
46.00	7.533	1097	1215
48.00	8.202	1195	1323
50.00	8.900	1297	1436
52.00	9.626	1402	1553
54.00	10.381	1512	1675
56.00	11.164	1626	
58.00	11.976	1745	
60.00	12.816	1867	

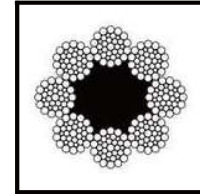

8X36 WS=8X[1+7+(7+7)+14] FC

EN12385
JUS C.H1.112
DIN 3067

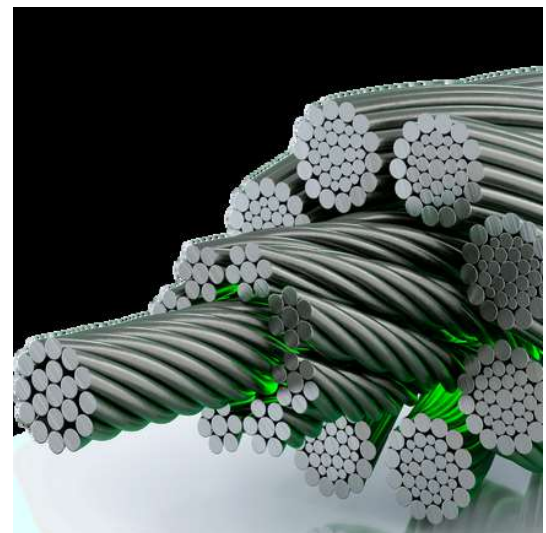

WIRE ROPE

Steel Wire Ropes

Prečnik užeta Rope Dia. mm	Težina Unit Weight kg/m	Zatezna čvrstoća / Wire Tensile	
		1770 N/mm ²	1960 N/mm ²
		Minimalna prekidna sila kN Minimum Breaking Load (MBL) kN	
10.00	0.435	63.0	69.8
11.00	0.526	76.2	84.4
12.00	0.626	90.7	100.5
13.00	0.735	106.5	117.9
14.00	0.853	124	137
15.00	0.979	142	157
16.00	1.114	161	179
17.00	1.257	182	202
18.00	1.409	204	226
19.00	1.570	227	252
20.00	1.740	252	279
21.00	1.918	278	308
22.00	2.105	305	338
23.00	2.301	333	369
24.00	2.506	363	402
25.00	2.719	394	436
26.00	2.941	426	472
27.00	3.171	459	509
28.00	3.410	494	547
29.00	3.658	530	587
30.00	3.915	567	628
31.00	4.180	606	671
32.00	4.454	645	715
33.00	4.737	686	760
34.00	5.029	728	807
35.00	5.329	772	855
36.00	5.638	817	904
37.00	5.955	863	955
38.00	6.281	910	1008
39.00	6.616	958	1061
40.00	6.960	1008	1116
41.00	7.312	1059	1173
42.00	7.673	1112	1231
43.00	8.043	1165	1290
44.00	8.422	1220	1351
46.00	9.205	1333	1476
48.00	10.022	1452	1608
50.00	10.875	1575	1744
52.00	11.762	1704	1887
54.00	12.685	1837	2035
56.00	13.642	1976	
58.00	14.633	2120	
60.00	15.660	2268	

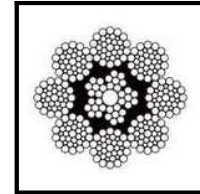

8X36 WS=8X[1+7+(7+7)+14] IWRC

EN12385
JUS C.H1.112
DIN 3067

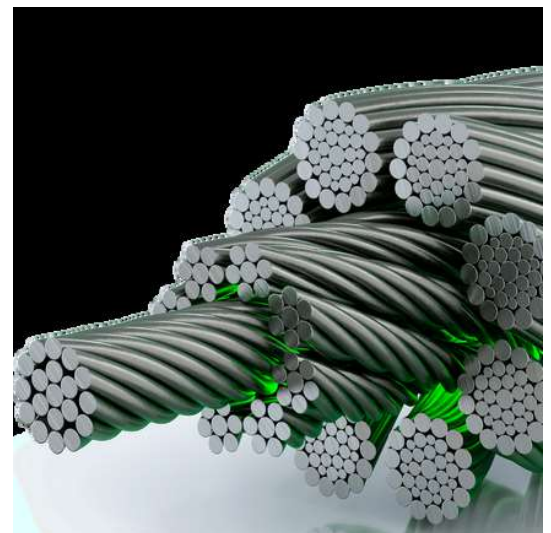

Steel Wire Ropes

Prečnik užeta Rope Dia.mm	Težina Unit Weight kg/m	Zatezna čvrstoća / Wire Tensile		
		1570 N/mm ²	1770 N/mm ²	1960 N/mm ²
		Računska prekidana sila kN Calculated Breaking Load kN		
10	0.295	53.1	59.9	66.3
12	0.497	76.5	86.3	95.6
13	0.584	89.8	101	112
16	0.884	136	153	169
17	0.918	153	173	192
18	1.12	172	194	215
20	1.38	213	240	266
22	1.67	257	290	321
24	1.99	306	345	382
26	2.33	359	405	448
29	2.62	447	504	558
32	3.54	544	614	680
34	3.99	614	693	767
36	4.47	689	777	860
40	5.52	850	959	1062
42	6.09	937	1057	1170
45	6.27	1076	1213	1343
48	7.96	1224	1380	1528
50	8.63	1329	1498	1659
52	9.34	1437	1620	1794
55	9.53	1608	1812	2007
58	11.6	1788	2016	2232

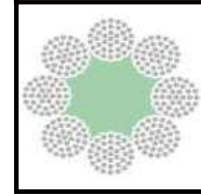

8X37 = 8X[1+6+12+18]+FC/VJ
EN 12385-4:2002
JUS C.H1.084

Prečnik užeta Rope Dia.mm	Težina Unit Weight kg/m	Zatezna čvrstoća / Wire Tensile		
		1570 N/mm ²	1770 N/mm ²	1960 N/mm ²
		Računska prekidana sila kN Calculated Breaking Load kN		
10	0.38	70.8	79.9	88.4
12	0.612	102	115	127
13	0.719	120	135	149
16	1.08	181	204	225
17	1.14	204	231	256
18	1.37	230	259	286
20	1.7	283	320	355
22	2.05	343	387	428
24	2.65	408	460	509
26	2.87	479	540	597
29	3.23	596	672	744
32	4.35	726	818	907
34	4.91	819	924	1023
36	5.51	918	1035	1147
40	6.8	1134	1278	1416
42	7.5	1250	1409	1560
45	7.71	1435	1617	1791
48	9.8	1633	1841	2037
50	10.6	1772	1997	2212
52	11.5	1916	2160	2392
55	11.8	2144	2416	2676
58	17.3	2384	2688	2976

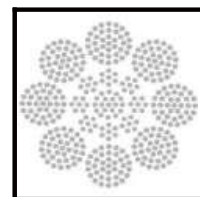

8X37 = 8X[1+6+12+18]+IWRC/ČJ
EN 12385-4:2002
JUS C.H1.084

WIRE ROPE

Steel Wire Ropes

Prečnik užeta Rope Dia. mm	Težina Unit Weight kg/m	Zatezna čvrstoća / Wire Tensile	
		1770 N/mm ²	1960 N/mm ²
		Minimalna prekidna sila (MBL) / kN	
10.00	0.382	58.1	64.3
11.00	0.462	70.2	77.8
12.00	0.550	83.6	92.6
13.00	0.646	98.1	108.6
14.00	0.749	113.8	126
15.00	0.860	131	145
16.00	0.978	149	165
17.00	1.104	168	186
18.00	1.238	188	208
19.00	1.379	210	232
20.00	1.528	232	257
21.00	1.685	256	284
22.00	1.849	281	311
23.00	2.021	307	340
24.00	2.200	334	370

NOTE: Larger diameters available upon request.

Prečnik užeta Rope Dia. mm	Težina Unit Weight kg/m	Zatezna čvrstoća / Wire Tensile	
		1770 N/mm ²	1960 N/mm ²
		Minimalna prekidna sila (MBL) / kN	
4.00	0.064	-	10.3
5.00	0.100	-	16.1
6.00	0.144	-	23.1
7.00	0.197	-	31.5
8.00	0.257	-	41.1
9.00	0.325	-	52.1
10.00	0.401	58.1	64.3
11.00	0.485	70.2	77.8
12.00	0.577	83.6	92.6
13.00	0.678	98.1	108.6
14.00	0.786	113.8	126
15.00	0.902	131	145
16.00	1.027	149	165
17.00	1.159	168	186
18.00	1.299	188	208
19.00	1.448	210	232
20.00	1.604	232	257
21.00	1.768	256	284
22.00	1.941	281	311
23.00	2.121	307	340
24.00	2.310	334	370

NOTE: Larger diameters available upon request.

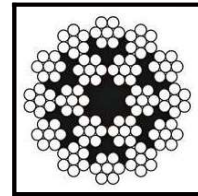

19x7=1x(1+6)+6x(1+6)+12x(1+6)+FC

EN12385-4
JUS C.H1.115
DIN 3069

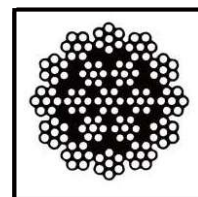

19x7=1x(1+6)+6x(1+6)+12x(1+6)+IWRC

EN12385-4
JUS C.H1.115
DIN 3069

Steel Wire Ropes

Prečnik užeta Rope Dia. mm	Težina Unit Weight kg/m	Zatezna čvrstoća Wire Tensile
		Minimalna prekidna sila (MBL) kN
10.00	0.425	1960 N/mm ² 48
11.00	0.512	81
12.00	0.602	114
13.00	0.712	147
14.00	0.821	170
15.00	0.942	195
16.00	1.061	218
18.00	1.373	276
19.00	1.505	335
20.00	1.650	400
22.00	2.030	489
24.00	2.430	578

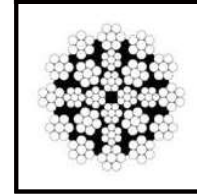

24X7=[FC+4X(1+6)+4X(1+6)+4X(1+6)]+12X(1+6) FC

EN12385



Prečnik užeta Rope Dia. mm	Težina Unit Weight kg/m	Zatezna čvrstoća / Wire Tensile		
		1570 N/mm ²	1770 N/mm ²	1960 N/mm ²
		Računska prekidana sila kN Calculated Breaking Load kN		
12	0.579	98.5	111	123
13	0.677	115	130	144
14	0.819	134	151	167
15	0.884	154	173	192
16	1.058	175	197	219
17	1.188	198	223	247
18	1.327	222	250	277
19	1.445	247	278	308
20	1.538	274	309	342
22	1.86	331	373	413
24	2.211	394	444	492
26	2.77	463	521	577
28	3.195	536	605	670
30	3.651	616	694	769
32	4.204	701	790	875

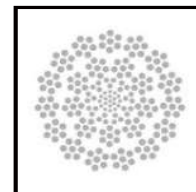

24x7+9x3+19= 15(1+6)+9(1+6)+9(3)+1(1+6+12)

EN12385
JUS C.H1-120

WIRE ROPE

Steel Wire Ropes

Prečnik užeta Rope Dia. mm	Težina Unit Weight kg/m	Zatezna čvrstoča / Wire Tensile	
		1960 N/mm ²	2160 N/mm ²
		Minimalna prekidna sila (MBL) / kN	
9.00	0.35	65	69
10.00	0.43	81	86
11.00	0.52	98	103
12.00	0.62	117	124
13.00	0.73	127	135
14.00	0.85	132	141
15.00	0.97	137	146
16.00	1.08	204	217
17.00	1.23	232	246
18.00	1.37	257	273
19.00	1.54	290	308
20.00	1.73	325	345
21.00	1.89	357	379
22.00	2.08	391	415
23.00	2.27	427	454
24.00	2.48	466	496
25.00	2.70	508	540
26.00	2.91	548	582
27.00	3.14	591	628
28.00	3.38	635	675
30.00	3.86	725	770
32.00	4.34	816	870
34.00	4.88	918	975
35.00	5.13	965	1025
36.00	5.55	1044	1110
38.00	6.26	1182	1255
40.00	6.91	1303	1380
41.00	7.28	1368	1445
42.00	7.60	1428	1508
44.00	8.31	1565	1654
46.00	9.10	1711	1811
48.00	9.92	1863	1972
50.00	10.76	2029	2135
52.00	11.62	2185	2313
54.00	12.53	2357	2494
56.00	13.48	2535	2682
58.00	14.46	2719	2877
60.00	15.47	2910	3079
62.00	16.52	3107	3288
64.00	17.60	3311	3504
66.00	18.72	3521	3726

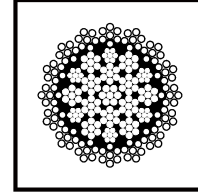

35(W)X7=6X(1+6)+12X(1+6)+17X(1+6) IWRC

EN12385-4

DIN 3072



Steel Wire Ropes

Prečnik užeta Rope Dia. mm	Težina Unit Weight kg/m	Zatezna čvrstoća / Wire Tensile		
		1570 N/mm ²	1770 N/mm ²	1960 N/mm ²
		Računska prekidana sila kN Calculated Breaking Load kN		
12	562	941	106	117
13	659	110	125	138
14	765	128	144	160
16	999	167	189	209
18	126	212	239	264
20	156	261	295	326
22	189	316	357	395
24	225	376	424	470
26	264	442	498	551
28	306	512	578	640
32	400	669	755	835
36	506	847	955	1057
40	624	1050	1180	1305

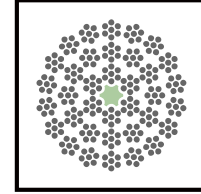

36X7=18(1+6)+12(1+6)+6(1+6)+FC/VJ

EN12385

JUS C.H1.0118

Prečnik užeta Rope Dia. mm	Težina Unit Weight kg/m	Zatezna čvrstoća / Wire Tensile		
		1570 N/mm ²	1770 N/mm ²	1960 N/mm ²
		Računska prekidana sila kN Calculated Breaking Load kN		
12	579	969	109	121
13	679	114	128	142
14	788	132	149	165
16	103	172	194	215
18	130	218	246	272
20	161	269	304	336
22	195	326	367	407
24	231	388	437	484
26	272	455	513	568
28	315	528	595	659
32	412	689	777	860
36	521	872	983	1088
40	643	1080	1210	1344

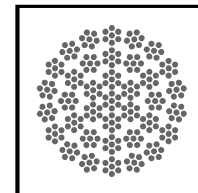

36X7=18(1+6)+12(1+6)+6(1+6)+IWR/CČJ

EN12385

JUS C.H1.0118

WIRE ROPE

Steel Wire Ropes

Prečnik užeta Rope Dia. mm	Težina Unit Weight kg/m	Zatezna čvrstoća / Wire Tensile	
		1960 N/mm ²	2160 N/mm ²
		Minimalna prekidna sila (MBL) / kN Minimum Breaking Load (MBL) / kN	
12	69.1	124	137
13	81.1	146	161
14	94.1	169	194
15	108	194	214
16	123	221	243
17	139	249	275
18	156	279	308
19	173	311	343
20	192	345	380
21	212	380	419
22	232	417	460
23	254	456	503
24	276	497	547
25	300	539	594
26	324	583	642
27	350	629	693
28	376	676	745
29	404	725	799
30	432	776	855
32	492	883	973
34	555	997	1099
36	622	1118	1232
38	693	1245	1372
40	768	1380	1521

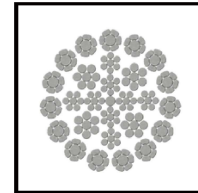

H NR 15 CK

Constant figures for all diam :

- ▶ Tol on diam.: +1% +4%
- ▶ Filling Factor(f): $27 \times 7 = 0,648$
 $31 \times 7 = 0,660$
- ▶ Torque factor: 0,007
- ▶ Modulus of elasticity E : 112000N/mm²
(+ou-4000)



Constructon:

- HNR 15 CK-Non rotating
- 15 outer strands compacted
- Lanf lay (right or left)
- Warrington core(compacteds strands)
- Higt MBL
- Wearing resistand lubricaton for hoist ropes

Can be used with a swivel, even for single fall

Steel Wire Ropes

Prečnik užeta Rope Dia. mm	Težina Unit Weight kg/m	Zatezna čvrstoča / Wire Tensile	
		1960 N/mm ²	2160 N/mm ²
		Minimalna prekidna sila (MBL) / kN Minimum Breaking Load (MBL) / kN	
12	0,71	126	138
13	0,84	150	163
14	0,98	174	190
15	1,12	199	217
16	1,23	223	246
17	1,39	252	278
18	1,56	283	311
19	1,73	315	347
20	2,01	357	394
22	2,41	430	474
24	2,84	505	551
26	3,35	598	652
28	3,91	696	760
30	4,46	794	866
32	5,03	896	977
34	5,74	1023	
36	6,42	1141	
38	7,18	1279	
40	7,93	1412	
42	8,70	1549	

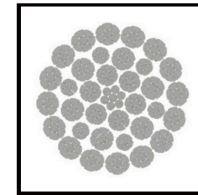

H35 NRK

Constant figures for all diam :

- ▶ Tol on diam.: dedign "H": +1% +4%
- ▶ Filling Factor(f): 0,729
- ▶ Torque factor: 0,007
- ▶ Modulus of elasticity E : 110000N/mm²
(+ ou - 4000)



Safety:

H35 NRC (lang) is closed such that internal contacts between the outer wires and inner strands can be linear which increase durability of rope. If broken wires occur, they will appear on the outer wires first.

WIRE ROPE

Steel Wire Ropes

Prečnik užeta Rope Dia. mm	Težina Unit Weight kg/m	Zatezna čvrstoća Wire Tensile
		2160 N/mm ²
		Minimalna prekidna sila (MBL) / kN
8.00	0.26	49
9.00	0.33	62
10.00	0.41	75
11.00	0.50	93
12.00	0.59	111
13.00	0.69	130
14.00	0.80	151
15.00	0.92	173
16.00	1.05	197
17.00	1.18	222
18.00	1.33	248
19.00	1.48	278
20.00	1.64	308
21.00	1.80	335
22.00	1.98	372
23.00	2.16	407
24.00	2.36	443
25.00	2.56	484
26.00	2.77	520
27.00	2.98	565
28.00	3.21	603
29.00	3.44	652
30.00	3.68	687
31.00	3.93	744
32.00	4.19	787
33.00	4.45	840
34.00	4.73	889
35.00	5.01	941
36.00	5.30	997
37.00	5.60	1048
38.00	5.91	1103
39.00	6.22	1159
40.00	6.54	1230
41.00	6.88	1275
42.00	7.22	1335
43.00	7.56	1396
44.00	7.92	1489
45.00	8.28	1522
46.00	8.65	1586
47.00	9.04	1652
48.00	9.42	1688
49.00	9.82	1766
50.00	10.23	1858
51.00	10.64	1929
52.00	11.06	1987
53.00	11.49	2074
54.00	11.93	2149
55.00	12.37	2224
56.00	12.83	2319
57.00	13.29	2380
58.00	13.76	2459
59.00	14.24	2540
60.00	14.73	2618
61.00	15.22	2705
62.00	15.72	2789
63.00	16.23	2875
64.00	16.75	2962
65.00	17.28	3050
66.00	17.82	3119
67.00	18.36	3299
68.00	18.91	3398
69.00	19.47	3499
70.00	20.04	3601
71.00	20.62	3705
72.00	21.20	3810
73.00	21.80	3916
74.00	22.40	4024
75.00	23.01	4134
76.00	23.62	4245
77.00	24.25	4357
78.00	24.88	4471
79.00	25.53	4586
80.00	26.18	4703

NOTE: Other diameters available upon request.

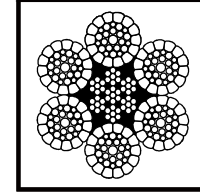

6X36 WS=6X[1+7+(7+7)+14] - IWRC
COMPACTED STRAND
EN12385-4
JUS C.H1.108
DIN 3064



Steel Wire Ropes

Prečnik užeta Rope Dia. mm	Težina Unit Weight kg/m	Zatezna čvrstoča / Wire Tensile	
		1960 N/mm ²	2160 N/mm ²
		Minimalna prekidna sila (MBL) / kN	
10	0.45	86	91
11	0.55	104	110
12	0.65	125	130
12,7	0.71	136	143
13	0.77	147	153
14	0.90	170	178
15	1.03	194	204
16	1.15	211	222
18	1.48	272	286
19	1.63	300	315
20	1.84	338	356
22	2.17	399	421
24	2.55	487	512
25.4	2.88	532	561
26	3.05	562	592
28	3.55	655	690
28,6	3.67	676	712
30	4.13	758	798
32	4.70	864	910
34	5.26	972	
35	5.50	1010	
36	5.97	1096	
38	6.61	1142	
40	7.30	1346	
41	7.58	1398	
42	7.98	1469	
44	9.00	1657	
44,5	9.06	1665	
46	9.78	1799	
48	10.66	1963	
50	11.70	2150	
50,8	11.87	2179	
52	12.60	2316	

Constant figures for all diam :

- ▶ Tol on diam.: +1% +4%
- ▶ Filling Factor(f): 8 x K26=0,668 - 8 x K31=0,672
8 x K36=0,682
- ▶ Modulus of elasticity : E : 112000N/mm²
(+ ou - 4000)

H 8PK

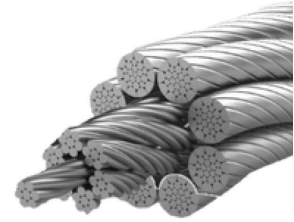
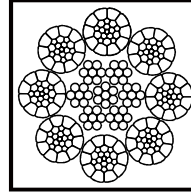

Constructor:

- 8xK26WS: 10 mm -28,6mm
- 8xK31WS: 30-42mm
- 8xK36WS: 44-60mm
- Steel core and compacted
- Gavanized -Regular lay (R or L)

Options: Bright steel* Lang lay without plastic
Can't be used with a swivel

Prečnik užeta Rope Dia. mm	Težina Unit Weight kg/m	Zatezna čvrstoča / Wire Tensile	
		1960 N/mm ²	2160 N/mm ²
		Minimalna prekidna sila (MBL) / kN	
10	0.45	86	91
11	0.55	104	110
12	0.65	125	130
12,7	0.71	136	143
13	0.77	147	153
14	0.90	170	178
15	1.03	194	204
16	1.15	211	222
18	1.48	272	286
19	1.63	300	315
20	1.84	338	356
22	2.17	399	421
24	2.55	487	512
25.4	2.88	532	561
26	3.05	562	592
28	3.55	655	690
28,6	3.67	676	712
30	4.13	758	798
32	4.70	864	910
34	5.26	972	
35	5.50	1010	
36	5.97	1096	
38	6.61	1142	
40	7.30	1346	
41	7.58	1398	
42	7.98	1469	
44	9.00	1657	
44,5	9.06	1665	
46	9.78	1799	
48	10.66	1963	
50	11.70	2150	
50,8	11.87	2179	
52	12.60	2316	

Constant figures for all diam :

- ▶ Tol on diam.: +1% +4%
- ▶ Filling Factor(f): 8 x K26=0,668 - 8 x K31=0,672
8 x K36=0,682
- ▶ Modulus of elasticity : E : 112000N/mm²
(+ ou - 4000)

H 8PK PI

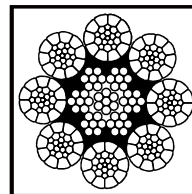

Constructor:

- 8xK26WS: 10 mm -28,6mm
- 8xK31WS: 30-42mm
- 8xK36WS: 44-60mm
- Steel core and compacted
- Gavanized -Regular lay (R or L)
- Plastic impregnated core (Not applicable with 10mm-20mm)

Can't be used with a swivel

WIRE ROPE

Basic types of single-leg slings



HF 1-1



HF 1-2



HF 1-3



HF 1-4



HF 1-5

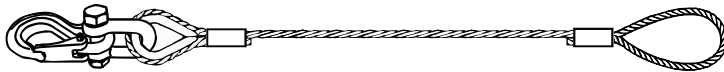

HF 1-6



HF 1-7



HF 1-8

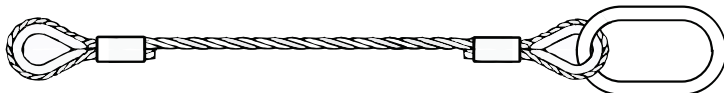

HF 1-9

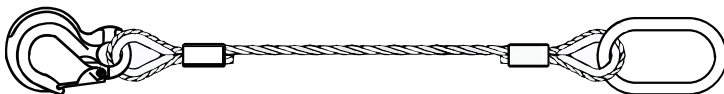

HF 1-10



HF 1-11



HF 1-12



HF 1-1G

* TABLE MADE ON THE BASIS OF STEEL ROPE OF CONSTRUCTION 6x19; 6x26; 6X36WS WITH TENSILE STRENGTH 1960N/mm²

* SAFETY FACTOR 5:1

* POSSIBILITY OF MAKING OTHER TYPES OF SLINGS AT THE BUYER'S REQUEST.

* STANDARD MATERIAL: UN-GALVANIZED WIRE ROPE – GALVANIZED VERSION AVAILABLE ON REQUEST.

ALL SLINGS ARE MANUFACTURED IN ACCORDANCE WITH EN 13414-1, WITH EYES AND END FITTINGS SECURED BY ALUMINIUM CYLINDRICAL PRESSED FERRULES IN ACCORDANCE WITH EN 13411-3. (UPON CUSTOMER REQUEST, CONICAL ALUMINIUM PRESSED FERRULES COMPLIANT WITH EN 13411-3, TYPE C, CAN BE APPLIED.)

NOTE: option:  NFC identification

WIRE ROPE SLING

Load capacities of single-leg slings (WLL)

Rope diameter (mm)	Capacity - WLL (kg) - FC	Capacity - WLL (kg) - IWRC	Master link	Internal dimensions of Master link (mm)
6	380	410	A13	60x110
8	760	800	A13	60x110
10	1200	1300	A13	60x110
12	1700	1850	A16	60x110
13	2000	2170	A16	60x110
14	2300	2500	A16	60x110
16	3000	3300	A18	75x135
18	3800	4100	A22	90x160
19	4200	4600	A22	90x160
20	4700	5100	A22	90x160
22	5700	6200	A26	100x180
24	6850	7380	A26	100x180
26	8000	8600	A32	110x200
27	8600	9400	A36	140x260
28	9300	10000	A36	140x260
30	10700	11600	A36	140x260
32	12100	13100	A36	140x260
34	13700	14800	A36	140x260
36	15400	16600	A36	140x260
38	17000	18600	A36	140x260
40	19000	20500	A45	180x340
42	20800	22700	A45	180x340
44	22900	24800	A50	190x350
46	24900	27200	A50	190x350
48	27300	29500	A50	190x350
50	29600	32000	A50	190x350
52	32100	34690	A50	190x350
60	42800	46000	A56	200x400

Manual Hoisting Equipments

Electric Hoisting Equipments

Textile Sling and Height Safety

Transport and Load Restraints

Lifting Chain/Chain Sling/Components

Wire Rope/Wire Rope Sling/Components

Forestry and Rigging Hardware

Material Handling Equipments

WIRE ROPE SLING

Basic types of double-leg slings

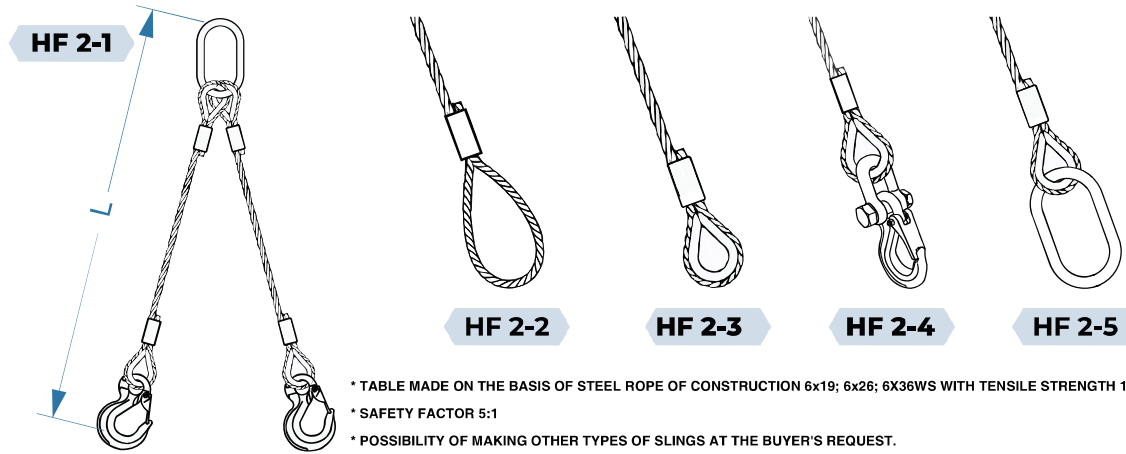

- * TABLE MADE ON THE BASIS OF STEEL ROPE OF CONSTRUCTION 6x19; 6x26; 6X36WS WITH TENSILE STRENGTH 1960N/mm²
- * SAFETY FACTOR 5:1
- * POSSIBILITY OF MAKING OTHER TYPES OF SLINGS AT THE BUYER'S REQUEST.
- * STANDARD MATERIAL: UN-GALVANIZED WIRE ROPE – GALVANIZED VERSION AVAILABLE ON REQUEST.

ALL SLINGS ARE MANUFACTURED IN ACCORDANCE WITH EN 13414-1, WITH EYES AND END FITTINGS SECURED BY ALUMINIUM CYLINDRICAL PRESSED FERRULES IN ACCORDANCE WITH EN 13411-3. (UPON CUSTOMER REQUEST, CONICAL ALUMINIUM PRESSED FERRULES COMPLIANT WITH EN 13411-3, TYPE C, CAN BE APPLIED.)

NOTE: option:  NFC identification

Load capacities of double-leg slings (WLL)

Rope diameter (mm)	Capacity - WLL - (kg) - FC		Capacity - WLL - (kg) - IWRC		Master link	Internal dimensions of Master link (mm)
	$\beta=45^\circ$	$\beta=60^\circ$	$\beta=45^\circ$	$\beta=60^\circ$		
6	700	510	800	680	A13	60X110
8	1000	760	1150	820	A13	60X110
10	1600	1200	1800	1300	A16	60X110
12	2400	1700	2600	1800	A18	75X135
13	2800	2000	3000	2170	A18	75X135
14	3200	2300	3500	2500	A18	75X135
16	4300	3000	4600	3300	A22	90X160
18	5400	3800	5800	4100	A22	90X160
19	5900	4200	6400	4600	A26	100X180
20	6600	4750	7100	5100	A26	100X180
22	8000	5750	8700	6200	A32	110X200
24	9600	6850	10300	7400	A36	140X260
26	11200	8000	12100	8600	A36	140X260
27	12000	8600	13100	9400	A36	140X260
28	13000	9300	14000	10000	A36	140X260
30	15000	10700	16200	11600	A36	140X260
32	17000	12100	18300	13100	A36	140X260
34	19200	13700	20700	14800	A45	180X260
36	21500	15400	23200	16000	A45	180X260
38	23800	17000	26000	18600	A50	190X350
40	26700	19000	28700	20500	A50	190X350
42	29100	20800	31800	22700	A56	200X400
44	32100	22900	34700	24800	A56	200X400
46	34800	24900	39000	27900	A56	200X400
48	38300	27300	41300	29500	A56	200X400
50	41500	29600	44800	32000	A56	200X400
52	45000	32100	48600	34700	A56	200X400
60	59900	42800	64500	46000	A56	200X400

WIRE ROPE SLING

Basic types of three & four-legged slings

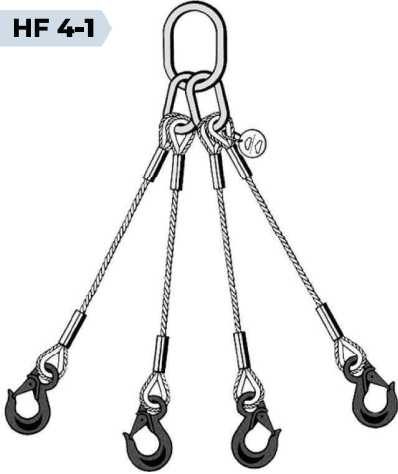
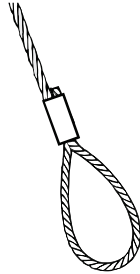
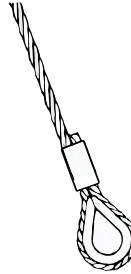
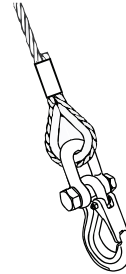
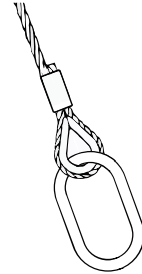
HF 4-1

HF 4-2

HF 4-3

HF 4-4

HF 4-5

- * TABLE MADE ON THE BASIS OF STEEL ROPE OF CONSTRUCTION 6x19; 6x26; 6X36WS WITH TENSILE STRENGTH 1960N/mm²
- * SAFETY FACTOR 5:1
- * POSSIBILITY OF MAKING OTHER TYPES OF SLINGS AT THE BUYER'S REQUEST.
- * STANDARD MATERIAL: UN-GALVANIZED WIRE ROPE – GALVANIZED VERSION AVAILABLE ON REQUEST.

ALL SLINGS ARE MANUFACTURED IN ACCORDANCE WITH EN 13414-1, WITH EYES AND END FITTINGS SECURED BY ALUMINIUM CYLINDRICAL PRESSED FERRULES IN ACCORDANCE WITH EN 13411-3. (UPON CUSTOMER REQUEST, CONICAL ALUMINIUM PRESSED FERRULES COMPLIANT WITH EN 13411-3, TYPE C, CAN BE APPLIED.)

NOTE: option:  NFC identification

Load capacities of three & four-legged slings (WLL)

Rope diameter (mm)	Capacity - WLL - (kg) - FC		Capacity - WLL - (kg) - IWRC		Master link	Internal dimensions of Master link (mm)
	$\beta=45^\circ$	$\beta=60^\circ$	$\beta=45^\circ$	$\beta=60^\circ$		
6	700	510	800	680	TG07.8	95x160
8	1600	1140	1720	1230	TG07.8	95x160
10	2500	1800	2700	1900	TG08.8	110x160
12	3600	2500	3850	2750	TG10.8	110x190
13	4200	3000	4550	3250	TG10.8	110x190
14	4900	3500	5300	3800	TG10.8	110x190
16	6400	4600	6900	4900	TG13.8	130x230
18	8000	5800	8700	6200	TG13.8	130x230
19	8800	6300	9700	6900	TG13.8	130x230
20	10000	7100	10750	7700	TG16.8	150x275
22	12000	8600	13000	9300	TG16.8	150x275
24	14400	10300	15500	11000	TG16.8	150x275
26	16800	12000	18200	13000	TG20.8	180x340
27	18000	12900	19700	14100	TG20.8	180x340
28	19500	13950	21000	15000	TG22.8	190x350
30	22400	16000	24200	17300	TG22.8	190x350
32	25500	18200	27500	19700	TG22.8	190x350
34	28800	20500	31000	22200	TG22.8	190x350
36	32000	23000	34800	24900	TG26.8	200x400
38	36000	25700	38800	27700	TG26.8	200x400
40	40000	28600	43100	30800	on request	
42	44000	31400	47400	33800	on request	
44	48100	34400	52000	37200	on request	
46	52750	37700	56900	40600	on request	
48	57400	41000	62000	44300	on request	
50	62300	44500	67200	48000	on request	
52	67400	48200	72800	52000	on request	

WIRE ROPE SLING

Standard Technical Information for Slings

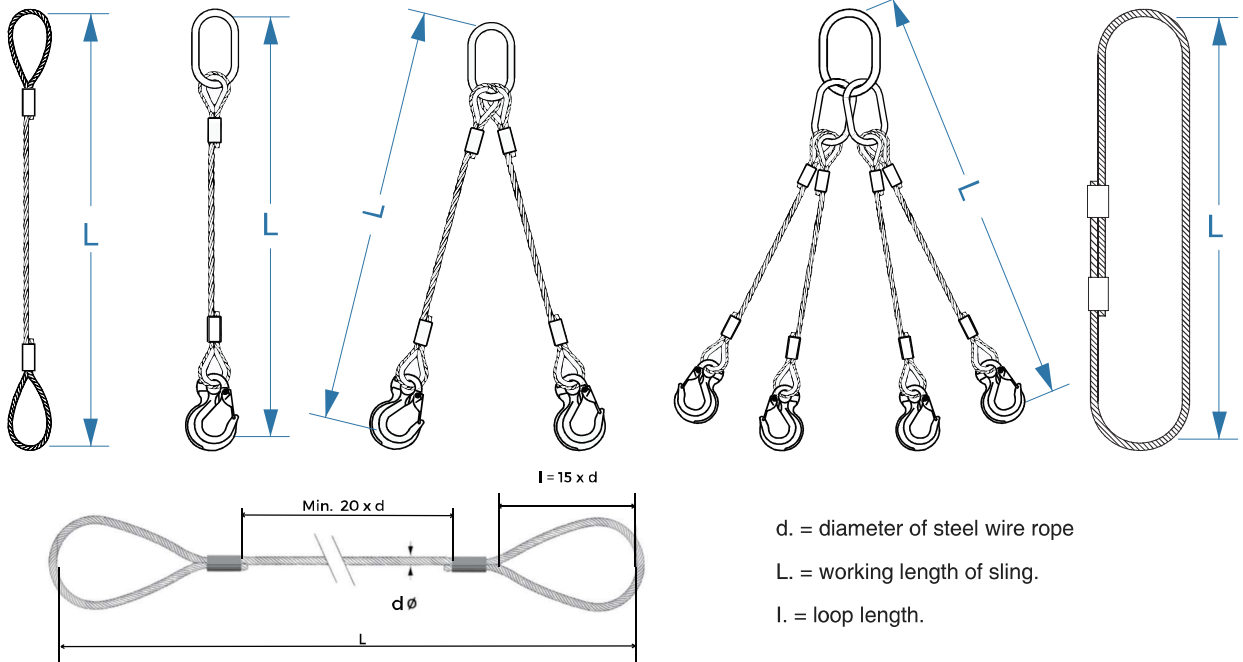

Testing laboratory accredited in accordance with ISO/IEC 17025

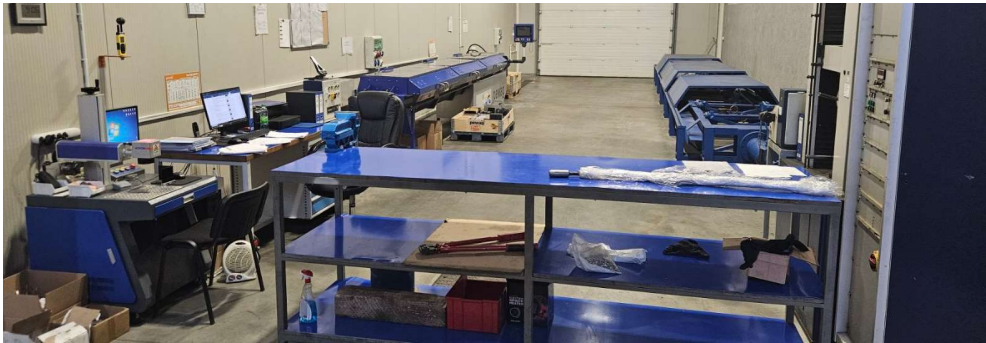

Identification of steel slings

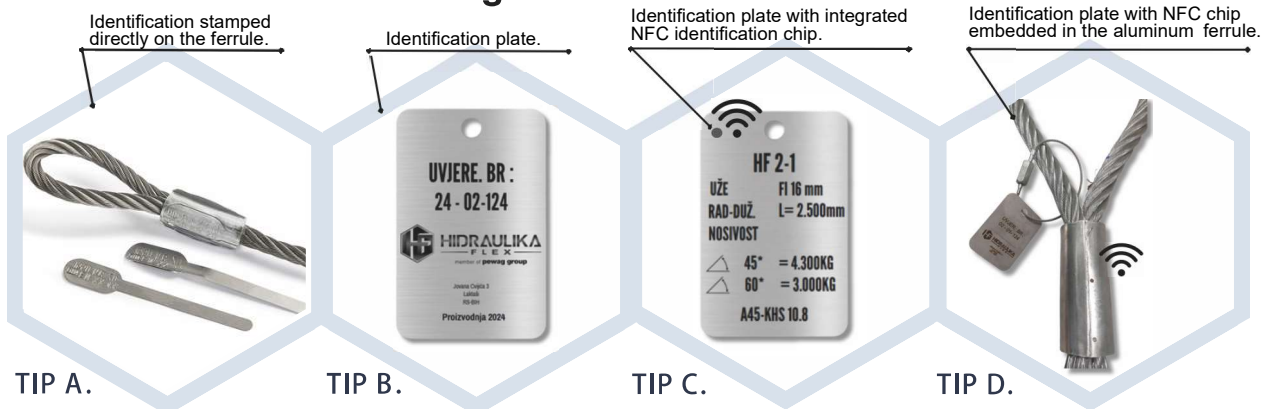

* Electronic tag identification available upon customer request

WIRE ROPE CLIP

A wire rope clip, sometimes called a u-bolt clamp or u-bolt clip, is used to clamp the loose end of a length of wire rope, once it has been looped back to form an eye. These fittings consist of a u-bolt and have a saddle secured by two nuts. Generally, wire rope assemblies need at least two or three wire rope clips to secure the ends properly to the length of the rope.

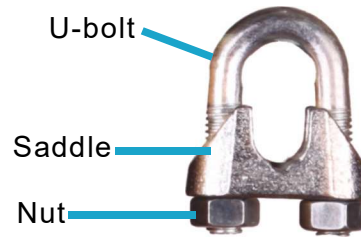

HOW TO USE WIRE ROPE CLIP

The saddle of the clip is the piece that fits into the U bolt. The dead-end of a wire rope is the end of the eye that contains the cut side. The U bolt should always be in contact with the dead-end, while the saddle should be on the live end.

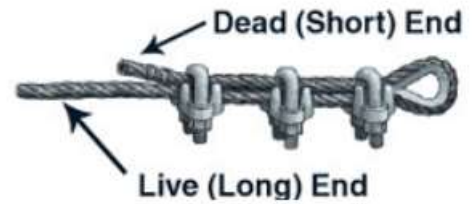

Usage of wire rope clips

The first clip has to be mounted close to the thimble. The distance between the wire rope clips has to be at least 1.5-times the width of a wire rope clip. The brackets have to be on the unstressed rope end.



The Right Way to Clip Wire Rope

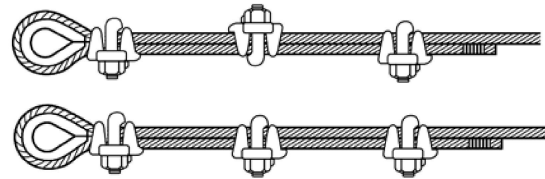

The Wrong Way to Clip Wire Rope

DIN 741 MALLEABLE WIRE ROPE CLIP

Cast saddles.
Electro galvanized or hot dip galvanized.
Sizes up to 50mm are available.

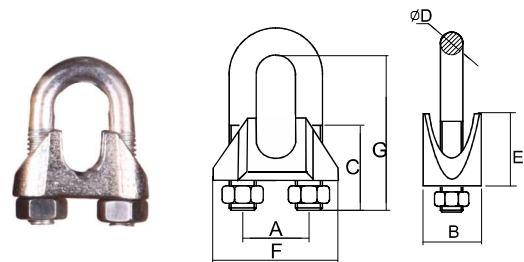

Item No.	Size	Dimensions(mm)							Weight kg	Product Code
		A	B	C	D	E	F	G		
WRCD03	3mm	9	10	8	4	8	18	16	0.008	
WRCD05	5mm	11	11	12	5	8	20	19	0.012	
WRCD06	6.5mm	13	12	15	5	10	23	23	0.015	
WRCD08	8mm	16	14	19	6	12	26	28	0.024	
WRCD10	10mm	19	18	22	8	17	34	34	0.055	
WRCD11	11mm	20	18	22	8	18	36	36	0.059	
WRCD13	13mm	24	23	30	10	21	42	45	0.105	
WRCD14	14mm	25	23	30	10	22	44	47	0.12	
WRCD16	16mm	29	23	33	12	23	50	51	0.17	
WRCD19	19mm	32	24	38	12	25	54	63	0.215	
WRCD22	22mm	37	29	44	14	32	61	71	0.34	
WRCD26	26mm	41	32	45	14	35	65	81	0.39	
WRCD30	30mm	48	35	50	16	43	74	90	0.57	
WRCD34	34mm	52	37	55	16	50	80	104	0.67	
WRCD40	40mm	58	40	60	16	53	88	124	0.82	

WIRE ROPE CLIP

DIN 1142/EN 13411-5 Type A Malleable Wire Rope Clip

Cast saddles.
Electro galvanized or yellow chromed.

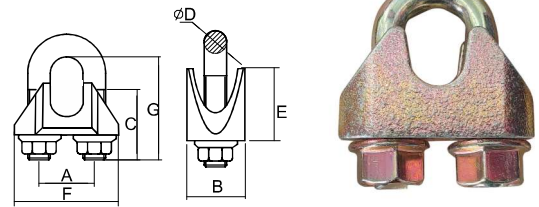

Item No.	Size	Dimensions(mm)							Weight kg	Product Code
		A	B	C	D	E	F	G		
WRCE05	5mm	12	13	13	5	13	25	20	0.021	
WRCE06	6.5mm	14	16	17	6	14	30	26	0.037	
WRCE08	8mm	18	20	20	8	18	39	33	0.075	
WRCE10	10mm	20	20	24	8	21	40	38	0.083	
WRCE12	12mm	24	24	28	10	25	50	45	0.17	
WRCE13	13mm	27	28	30	12	29	55	52	0.236	
WRCE14	14mm	28	28	31	12	30	59	56	0.27	
WRCE16	16mm	32	32	35	14	35	64	64	0.39	
WRCE19	19mm	36	32	36	14	40	68	69	0.46	
WRCE22	22mm	40	34	40	16	44	74	80	0.6	
WRCE26	26mm	46	38	50	20	51	84	91	1	
WRCE30	30mm	54	41	55	20	59	95	107	1.34	
WRCE34	34mm	60	45	60	22	67	105	119	1.88	
WRCE40	40mm	68	49	65	24	77	117	135	2.56	

U.S. FF-C-450 /EN 13411-5 Type B Drop Forged Wire Rope Clip

Drop forged saddles.
Electric galvanized or hot dip galvanized.
Other U-bolt's colors are also available.

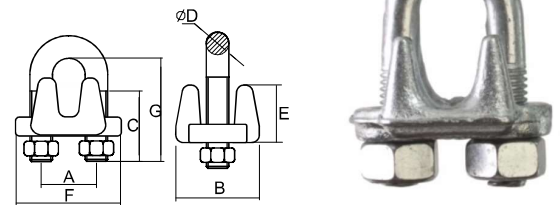

Item No.	Size	Dimensions(mm)							Weight kg	Product Code
		A	B	C	D	E	F	G		
WRCH03	1/8"	12	20.5	11	5.6	9.4	25	18.3	0.03	
WRCH04/05	3/16"	15	24	14	6.35	12.7	30	24.6	0.05	
WRCH06	1/4"	19	30	12.5	7.85	16.8	36.5	26.2	0.08	
WRCH08	5/16"	22.5	33.5	19	9.65	18.5	42	35.1	0.125	
WRCH10	3/8"	25.5	41.5	19	11.2	23	49	38.1	0.204	
WRCH11	7/16"	30	48.5	25.5	12.7	28.5	58	47.8	0.32	
WRCH13	1/2"	30	48.5	25.5	12.7	28.5	58	47.8	0.33	
WRCH14	9/16"	33.5	52.5	32	14.2	34	63.5	57	0.44	
WRCH16	5/8"	33.5	52.5	32	14.2	34	63.5	57	0.45	
WRCH19/20	3/4"	38	57	36.5	15.7	35.5	72	70	0.64	
WRCH22	7/8"	44.5	62	41	19.1	40	80.5	79	0.94	
WRCH24/26	1"	48	66.5	46	19.1	45	88	89	1.1	
WRCH30	1-1/8"	51	71.5	51	19.1	48.5	91	98.5	1.252	
WRCH32	1-1/4"	59	79.5	56	22.4	55	105	113	1.85	
WRCH36	1-3/8"	59	79.5	56	22.4	59	106	113	2	
WRCH38	1-1/2"	65.5	86.5	60.5	22.4	62	113	125	2.4	
WRCH42	1-5/8"	70	92	66.5	25.4	67.5	121	135	3.1	
WRCH45	1-3/4"	77.5	97	70	28.7	74	135	146	3.9	
WRCH50/52	2"	86	113	76	31.8	77	149	164	5.6	
WRCH58	2-1/4"	98.5	116	81	31.8	81	162	181	6.5	
WRCH64	2-1/2"	105	119	87.5	31.8	94	168	195	8	
WRCH69	2-3/4"	111	127	90.5	31.8	124	175	211	10.4	
WRCH76	3"	121	135	99	38.1	113	194	233	14	

WIRE ROPE THIMBLE

DIN6899 B TYPE WIRE ROPE THIMBLE

Medium-weight, with deep groove
 Electro galvanized or hot dip galvanized

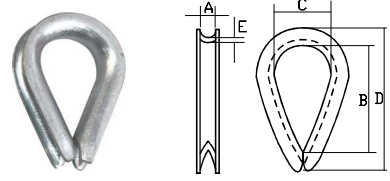

Item No.	Size	Dimensions(mm)					Weight kg	Product Code
		A	B	C	D	E		
WRTDB003	2.5x3MM	3	19	11.5	29	1.5	0.005	
WRTDB004	3.5x4MM	4	21	13	30	1.5	0.008	
WRTDB005	4x5MM	5	22	14	33	1.5	0.01	
WRTDB006	5x6MM	6	24	15	40	2	0.016	
WRTDB007	6x7MM	7	29	18	43	2	0.022	
WRTDB008	7x8MM	8	35	20	50	2	0.027	
WRTDB010	9x10MM	10	39	24	58	2	0.04	
WRTDB012	10x12MM	12	47	28	70	2.5	0.07	
WRTDB014	12x14MM	14	52	32	78	2.5	0.085	
WRTDB016	14x16MM	16	60	36	88	2.5	0.12	
WRTDB018	16x18MM	18	63	40	101	4	0.22	
WRTDB020	18x20MM	20	73	45	113	4	0.26	
WRTDB022	20x22MM	22	83	50	123	4	0.3	
WRTDB024	22x24MM	24	89	55	128	4	0.33	
WRTDB026	24x26MM	26	97	62	145	5	0.55	
WRTDB028	26x28MM	28	112	70	160	5	0.67	
WRTDB030	28x30MM	30	120	75	170	6	0.9	
WRTDB032	30x32MM	32	130	80	185	6	1.08	
WRTDB034	32x34MM	34	152	96	215	6	1.25	
WRTDB036	34x36MM	36	164	100	226	6	1.44	
WRTDB038	36x38MM	38	185	110	246	6	1.58	
WRTDB040	38x40MM	40	197	110	260	8	2.4	
WRTDB042	40x42MM	42	201	120	270	8	2.84	
WRTDB044	42x44MM	46	240	135	305	8	3.54	
WRTDB046	44x46MM	46	240	135	305	8	3.54	
WRTDB048	46x48MM	48	260	135	340	8	4.34	
WRTDB052	50x52MM	55	270	150	350	8	5	
WRTDB064	60x64MM	64	310	235	385	10	7.4	



WIRE ROPE THIMBLE

DIN3091 SOLID WIRE ROPE THIMBLE

The DIN 3091 Solid Thimble is a heavy-duty cast rigging fitting designed for extreme loads. Unlike standard open thimbles, it features a solid metal body with a pre-drilled pin hole, offering superior resistance to crushing and a rigid connection point for dredging, cranes, and heavy machinery.

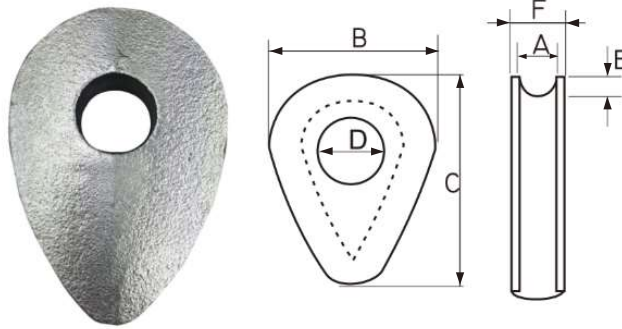

Item No.	Rope Dia.	Dimensions(mm)						Weight kg	Product Code
		A	B	C	D	E	F		
WRTDD08	8mm	9	40	56	14	4.5	15	0.137	
WRTDD10	10mm	11	50	70	18	6	17.5	0.255	
WRTDD12	12mm	13	60	84	21	7.5	20	0.442	
WRTDD14	14mm	16	70	98	25	9	23.5	0.648	
WRTDD16	16mm	18	80	110	28	10.5	26	0.91	
WRTDD18	18mm	20	90	130	31	12	28.5	1.285	
WRTDD20	20mm	22	100	140	35	13.5	31	1.67	
WRTDD22	22mm	24	110	150	38	15	33.5	2.11	
WRTDD24	24mm	26	120	170	41	16.5	36	2.6	
WRTDD26	26mm	29	130	180	44	18	39.5	3.62	
WRTDD28	28mm	31	140	200	47	20	42	4.38	
WRTDD32	32mm	35	160	220	53	23	47	6.05	
WRTDD36	36mm	40	180	250	59	26	53	8.61	
WRTDD40	40mm	44	200	280	65	29	58	11.8	

WIRE ROPE GRIP & WIRE ROPE FERRULE

Widely to be used in the power, communications and general construction fields to pull wire and cable.

- Forged alloy steel construction
- Zinc plated surface treatment for WRG type, and powder coated surface treatment for WRC type.
- The parallel jaws give a firm non-slip grip, not damaging the wire.
- Used for pulling up lines to tension only, not to be used as anchors.

WIRE ROPE GRIPS WRG TYPE

Item No.	Capacity (t)	Diameter (mm)	N.W. (kg)	Product Code
WRG-05	0.5	1-10	0.4	
WRG-10	1	2.5-16	0.75	
WRG-20	2	4-22	1.4	
WRG-30	3	16-32	2.35	



ALUMINIUM FERRULES

Aluminium ferrules provide the perfect way to secure a steel wire rope fitting in place with a tight compression fit. Size of the ferrule must be compatible to the diameter of the wire rope.

Note: aluminium sleeves are not recommended when using stainless steel cable, use zinc plated or copper sleeves instead.

DIN3093 ALUMINIUM FERRULES

Item No.	Size	Dimensions(mm)				Weight	Product Code
	mm	A	B	S	L	kgs/1000pcs	
WRFAF010	1	1.2	2.4	0.65	5	0.098	
WRFAF015	1.5	1.7	3.4	0.75	6	0.176	
WRFAF020	2	2.2	4.4	0.85	7	0.285	
WRFAF025	2.5	2.7	5.4	1.05	9	0.439	
WRFAF030	3	3.3	6.6	1.25	11	0.907	
WRFAF035	3.5	3.8	7.6	1.5	13	1.18	
WRFAF040	4	4.4	8.8	1.7	14	1.63	
WRFAF045	4.5	4.9	9.8	1.9	16	2.39	
WRFAF050	5	5.5	11.0	2.1	18	3.62	
WRFAF060	6	6.6	13.2	2.5	21	5.87	
WRFAF065	6.5	7.2	14.4	2.7	23	7.18	
WRFAF070	7	7.8	15.6	2.9	25	9.83	
WRFAF080	8	8.8	17.6	3.3	28	12.96	
WRFAF090	9	9.9	19.8	3.7	32	18.94	
WRFAF100	10	10.9	21.8	4.1	35	24.09	
WRFAF110	11	12.1	24.2	4.5	39	35.35	
WRFAF120	12	13.2	26.4	4.9	42	44.18	
WRFAF130	13	14.2	28.4	5.4	46	59.86	
WRFAF140	14	15.3	30.6	5.8	49	73.5	
WRFAF160	16	17.5	35.0	6.7	56	111	
WRFAF180	18	19.6	39.2	7.6	63	156	
WRFAF200	20	21.7	43.4	8.4	70	217	
WRFAF220	22	24.3	48.6	9.2	77	292	
WRFAF240	24	26.4	52.8	10.0	84	376	
WRFAF260	26	28.5	57.0	10.9	91	481	
WRFAF280	28	31.0	62.0	11.7	98	603	
WRFAF300	30	33.1	66.2	12.5	105	739	
WRFAF320	32	35.2	70.4	13.4	112	897	
WRFAF340	34	37.8	75.6	14.2	119	1077	
WRFAF360	36	39.8	79.6	15.0	126	1275	
WRFAF380	38	41.9	83.8	15.8	133	1503	
WRFAF400	40	44.0	88.0	16.6	140	1734	
WRFAF420	42	46.2	92.4	17.5	147	2024	
WRFAF440	44	48.4	96.8	18.3	154	2314	
WRFAF460	46	50.6	101.2	19.2	161	2662	
WRFAF480	48	52.8	105.6	20.0	168	3010	
WRFAF500	50	55.0	110.0	20.8	175	3412	
WRFAF520	52	57.2	114.4	21.6	182	3813	
WRFAF540	54	59.4	118.8	22.5	189	4293	
WRFAF560	56	61.6	123.2	23.3	196	4772	
WRFAF580	58	63.8	127.6	24.2	203	5326	
WRFAF600	60	66.0	132.0	25.0	210	5880	

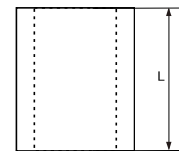
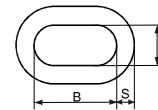

WIRE ROPE SOCKET

A wire rope socket is for permanent fixing to a wire rope. They provide the rope with a solid fitting for easier anchoring. The main types are spelter sockets and wedge sockets. Sockets are used in many areas including oil platforms, bridge construction and towing.

A spelter socket, attaches a termination fitting onto the end of a wire rope cable by pouring molten zinc or resin into a socket that then hardens and holds the fitting onto the end of the cable. Spelter sockets are one of the most efficient types of wire rope end attachments—delivering 100% efficiency of rope breaking strength.

An open socket has a pin or bolt that can attach the wire rope assembly to another type of fitting, or possibly a hook block. A closed socket fitting has a hole in it that is designed to accept a pin or bolt.

CLOSED SPELTER SOCKET WRSCS TYPE

Item No.	Rope Diameter		Dimensions(mm)													Product Code
	inch	mm	A	B	B1	B2	C	D	F	G	H	J	K	L	W	
WRSCS07	1/4	6-7	116	12.7	17	/	39.6	22.4	9.65	17.5	39.6	57.2	12.7	46	4	
WRSCS16	5/8	14-16	160	21	25	/	67	36	18	28	60.5	76	25.4	63.5	4	
WRSCS18	3/4	18	194	27	29	/	76	42	22	32	70	89	32	78	4	
WRSCS22	7/8	20-22	222	32	33	71	85	49	25.4	38	82.6	101.6	38	89	5	
WRSCS26	1	24-26	251	35	38	81	105	58.4	29	44.5	95	114	44.5	101.6	5	
WRSCS30	1-1/8	28-30	279	38	42	89	114	65	32	51	105	127	51	114	5	
WRSCS35	1-1/4 - 1-3/8	32-35	309	41.4	44	89	127	71	38.1	58.5	119	138	56.5	129	5	
WRSCS38	1-1/2	38	355	49.3	48	89	137	81	41.4	70.5	132	151	62.5	155	5	
WRSCS50	2	50	495	62	70	145	194	111	57	95	187	216	83	217	5	

OPEN SPELTER SOCKET WRSOS TYPE

Item No.	Rope Diameter	Dimensions(mm)													Product Code
	mm	A	B1	B2	C	D	F	G	H	J	L	M	N	W	
WRSOS08	6-8	123	10	/	23.5	17.5	9.65	17.5	39.6	57	39.6	33.3	9	4	
WRSOS10	8-10	123	12	/	21	21	13	21	43	57	44.5	38	11	4	
WRSOS13	11-13	141	14	/	25.4	25.4	14	24	48	63.5	51	48	13	4	
WRSOS16	14-16	171.5	16	/	32	30	17.5	29	57	76	63.5	57	14	4	
WRSOS18	18	202	18	/	38	35	20.6	32	66.5	89	76	66.5	16	4	
WRSOS22	20-22	235	20	65	44.5	41.4	24	38	83	101.6	89	79.5	20	5	
WRSOS26	24-26	268	24	72	51	51	29	44.5	95	114	101.6	95	22	5	
WRSOS30	28-30	300	28	85	57	57	32	51	104.6	127	117	105	25.4	5	
WRSOS32	30-32	335	32	95	63.5	63.5	38.1	57	121	140	127	121	28.7	5	
WRSOS38	36-38	384	36	112	76	70	41.4	70	133	163	148	137	30.2	5	
WRSOS41	39-41	413	40	120	76	76	45	76	140	165	165	146	33	5	
WRSOS45	43-45	464	50	150	89	89	51	79	162	191	178	165	40	5	
WRSOS54	51-54	548	50	145	102	97	57	93	145	223	228	178	47	5	
WRSOS60	57-60	597	63	155	114	108	63.5	102	210	229	254	197	54	5	

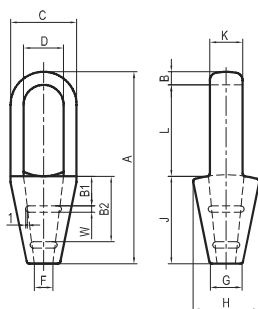

CLOSED SOCKET

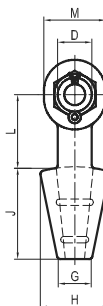

OPEN SOCKET

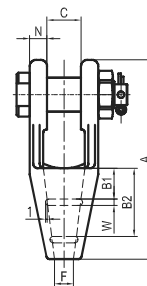

WIRE ROPE SOCKET

Wedge sockets secure the rope to the end attachment by passing it around a grooved, wedge-shaped piece of steel and pulling it down under load into the bowl of the fixture.

Wedge sockets are popular because they can be installed in field and adjusted in field – providing 80% efficiency of rope breaking strength. Wedge sockets are popular in applications where the wire rope may be subjected to abuse and abrasion—particularly in construction and mining applications.

Wedge sockets allow the end-user to adjust the length of a wire rope cable if exact and matched sets of crane cables are not available.

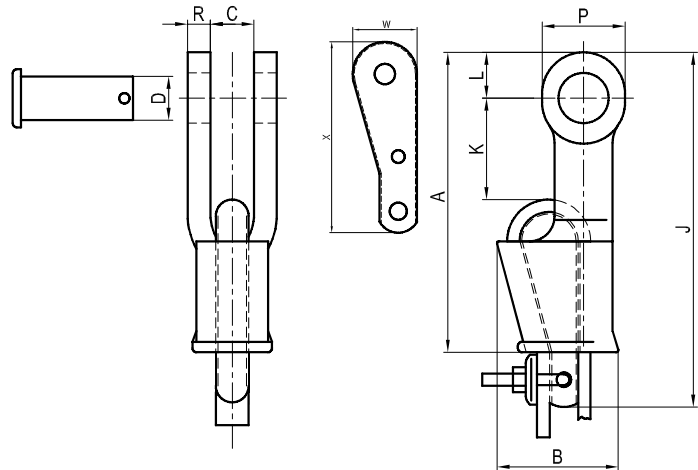

WEDGE SOCKET WRSWS TYPE

Item No.	Rope Diameter	Dimensions(mm)												Product Code
	mm	A	B	C	D	G	J	K	L	P	R	W	X	
WRSWS10	9-10	144.5	69	20.5	20	35	198	48	22	40	11	41	120	
WRSWS13	11-13	175	88	25.4	25	41	226	32	27	49	13	52	156	
WRSWS16	14-16	210	109	32	30	54	273	50.5	31	57	14	59	178	
WRSWS19	18-19	251	130	38	35	62	314	61	35.6	67	17	69	202	
WRSWS22	20-22	286	149	44.5	40.5	68	365	63	42	80	19	79	240	
WRSWS26	24-26	325	161	51	50.5	74.7	414	69	51	95.5	22.4	/	/	
WRSWS28	26-28	365	140	57	57	84	450	63.5	57	108	25.4	/	/	

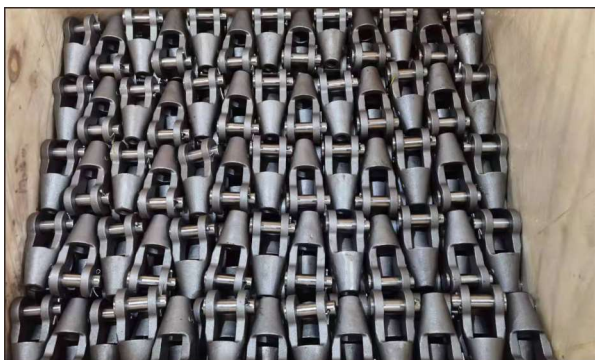

FORESTRY WIRE ROPES AND CHAINS

G80 SQUARE CHOKER CHAIN

Item No.	WLL(t)	BL(t)	Dia x Pitch x Inside Width	Weight(kg/m)
vkf7	3.25	6.5	7x24x10mm	1.23
vkf8	4.5	9	8x28x11mm	1.66



G100 SQUARE CHOKER CHAIN

Item No.	WLL(t)	BL(t)	Dia x Pitch x Inside Width	Weight(kg/m)
v6	3.2t	6.5	6x20x9mm	1.01
v7	4.5	9	7x24x10mm	1.35
v8	6	12	8x28x12mm	1.79
v10	8.5	17	10x35x14mm	2.55



GRADE 80 CLEVIS FOREST HOOK, CFK TYPE

- Allows an easy mounting and unhooking of the chain.
- Designed with a narrow throat opening to prevent the chain from slipping out.
- Quenched & tempered.
- 100% Magnaflex Crack Detection.

Standard: EN 1677
Material: forged alloy steel
Proof load: 2.5 times the Working Load Limit
Safety factor: 4:1
Surface finish: powder coated

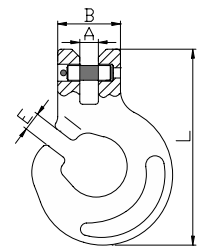

Item No.	Chain Size	WLL	Main Dimensions(mm)				Weight	Product Code
	mm	ton	B	A	E	L	kg	
8-CFK-06	6	1.12	31	8	8.5	83	0.286	
8-CFK-08	7+8	2	35	9.5	9.8	95.5	0.413	
8-CFK-10	10	3.15	44	13	13	137	0.92	
8-CFK-13	13	5.3	53	16	16	165	1.75	



FORESTRY WIRE ROPES AND CHAINS

GRADE 100 CLEVIS FOREST HOOK, CFK TYPE

- Allows an easy mounting and unhooking of the chain.
- Designed with a narrow throat opening to prevent the chain from slipping out.
- 25% stronger than G80
- Quenched & tempered.
- 100% Magnaflux Crack Detection.

Standard: EN 1677
 Material: forged alloy steel
 Proof load: 2.5 times the Working Load Limit
 Safety factor: 4:1
 Surface finish: powder coated

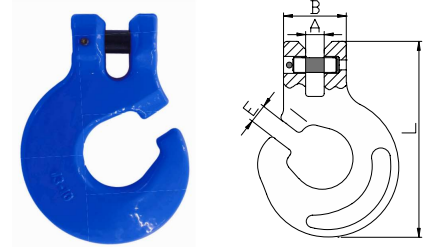

Item No.	Chain Size	WLL ton	Main Dimensions(mm)				Weight kg	Product Code
	mm		B	A	E	L		
10-CFK-08	8	2.5	35	9.5	9.8	95.5	0.41	
10-CFK-10	10	4	43	12	13	133	0.85	
10-CFK-13	13	6.7	59	16	16	162	1.87	

GRADE 80 SLIDING CHOKE HOOK, SCH TYPE

- Designed to secure a load by hitching the synthetic sling, wire rope sling or chain sling around the load circumference.
- Quenched & tempered.
- 100% Magnaflux Crack Detection.

Standard: EN 1677
 Material: forged alloy steel
 Proof load: 2.5 times the Working Load Limit
 Safety factor: 4:1
 Surface finish: powder coated



Item No.	Chain Size	WLL ton	Main Dimensions(mm)					Weight kg	Product Code
	inch		∅	A	B	E	L		
8-SCH-13	3/8-1/2	1.6	17	50	71	18	132	0.68	
8-SCH-16	5/8	2	22	63.5	79	20	151.3	1.21	
8-SCH-20	3/4	3	28	69	103	26	170	1.99	
8-SCH-26	1	5	32.5	85.7	135	33	213	4.18	

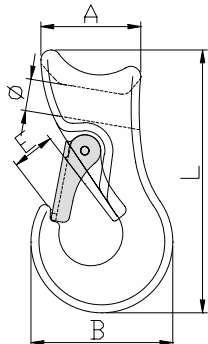

FORESTRY WIRE ROPES AND CHAINS

GRADE 80 CHAIN AND WIRE ROPE CONNECTOR, CRC TYPE

- Quenched & tempered.
- 100% Magnaflux Crack Detection.
- For log pulling only - not for lifting.

Standard: EN 1677
 Material: forged alloy steel
 Proof load: 2.5 times the Working Load Limit
 Safety factor: 4:1
 Surface finish: powder coated

Item No.	Chain Size	WLL	Main Dimensions(mm)						Weight	Product Code
	mm	ton	A	B	C	D	E	F	kg	
8-CRC-06	6	1.4	20	42	49	10	30	8	0.53	
8-CRC-08	7+8	2	20	42	49	11.5	33.5	10.5	0.65	
8-CRC-10	10	3.15	21.5	47	57	13	40	10.5	1	

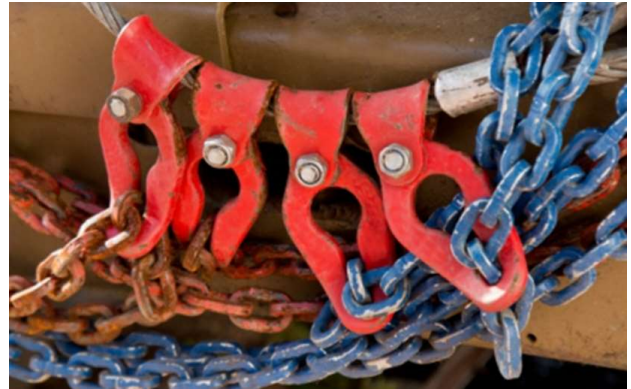
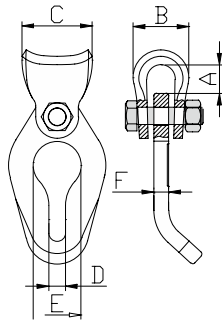

GRADE 100 CHAIN AND WIRE ROPE CONNECTOR, CRC TYPE

- Quenched & tempered.
- 100% Magnaflux Crack Detection.
- 25% stronger than G80
- For log pulling only - not for lifting.

Standard: EN 1677
 Material: forged alloy steel
 Proof load: 2.5 times the Working Load Limit
 Safety factor: 4:1
 Surface finish: powder coated

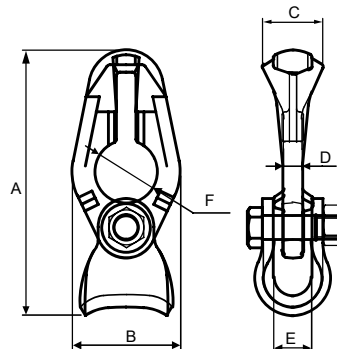

Item No.	Chain Size	WLL	Main Dimensions(mm)						Weight	Product Code
	mm	ton	A	B	C	D	E	F	kg	
10-CRC-08	7+8	2.5	142	70	32	10	20	33.5	0.65	
10-CRC-10	10	4	194.5	87.5	41	11.5	20	34	1.3	

FORESTRY WIRE ROPES AND CHAINS

STEEL ROPE FOR FORESTRY, NOOSES, FORESTRY CHAINS WITH HOOK



UM-STEEL ROPE 6X26 WS 1960 N/mm2 DOUBLE PRESSED BRITE-LUBRICATED RHOL (sZ) F100

Code	Name
11-UM10626ČJDP	UM-STEEL ROPE 10.00mm 6x26 PRO6 WS 1960 N/mm2 RHOL (sZ)
11-UM12626ČJDP	UM-STEEL ROPE 12.00 MM 6x26 PRO6 WS 1960 N/mm2 RHOL (sZ)
11-UM14626ČJDP	UM-STEEL ROPE 14.00 MM 6x26 PRO6 WS 1960 N/mm2 RHOL (sZ)
11-UM16626ČJDP	UM-STEEL ROPE 16.00 MM 6x26 PRO6 WS 1960 N/mm2 RHOL (sZ)



UM-STEEL ROPE 6X36 WS 1960 N/mm2 EN-12385-4 BRITE-LUBRICATED RHOL (sZ) F101

Code	Name
11-UM10636ČJ	UM-STEEL ROPE 10.00mm 6x36 WS 1960 N/mm2 RHOL (sZ)
11-UM12636ČJ	UM-STEEL ROPE 12.00mm 6x36 WS 1960 N/mm2 RHOL (sZ)
11-UM13636ČJ	UM-STEEL ROPE 13.00mm 6x36 WS 1960 N/mm2 RHOL (sZ)
11-UM14636ČJ	UM-STEEL ROPE 14.00mm 6x36 WS 1960 N/mm2 RHOL (sZ)
11-UM16636ČJ	UM-STEEL ROPE 16.00mm 6x36 WS 1960 N/mm2 RHOL (sZ)
11-UM18636ČJ	UM-STEEL ROPE 18.00mm 6x36 WS 1960 N/mm2 RHOL (sZ)

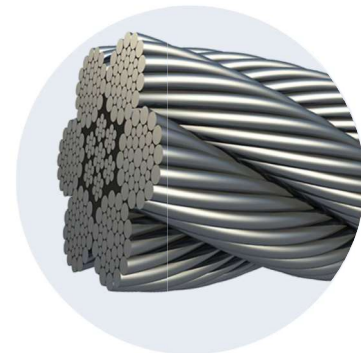

Manual Hoisting
Equipments

Electric Hoisting
Equipments

Textile Sling and
Height Safety

Transport and
Load Restraints

Lifting Chain/Chain
Sling/Components

Wire Rope/Wire Rope
Sling/Components

Forestry and
Rigging Hardware

Material Handling
Equipments

FORESTRY WIRE ROPES AND CHAINS

Forestry slings

Code	Name
11-DO14	D-SLINGS 14X1400 - HVB
11-DO16	D-SLINGS 14X1600 - HVB
11-DO18	D-SLINGS 14X1800 - HVB
11-DO20	D-SLINGS 14X2000 - HVB
11-DO22	D-SLINGS 14X2200 - HVB
11-DO24	D-SLINGS 14X2400 - HVB
11-DO26	D-SLINGS 14X2600 - HVB

Main rope sliders

Name
Angled – Small Eye – Straight Coupling
Angled – Large Eye – Straight Coupling
Angled – Small Eye – Side Coupling

- Rope constructions offered: 6x36WS+IWRC, 6x26+IWRC, 6x37+FC
- Option with steel plugs on both ends
- Option with one loop termination and one steel plug
- Compatible with multiple forestry slider types

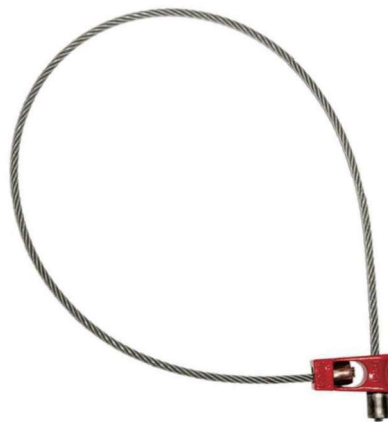

Version with steel plugs on both ends.



Version with a loop on one side and steel plug on the other.



Angled – Small Eye – Straight Coupling



Angled – Large Eye – Straight Coupling



Angled – Small Eye – Side Coupling

FORESTRY WIRE ROPES AND CHAINS

G80 Forestry chain

Name

FORESTRY CHAIN G80 08X2000 + HOOK

FORESTRY CHAIN G80 08X2500 + HOOK

FORESTRY CHAIN G80 08X3000 + HOOK

G100 Forestry chain

Name

FORESTRY CHAIN G100 06X2000 + HOOK

FORESTRY CHAIN G100 06X2500 + HOOK

FORESTRY CHAIN G100 08X2000 + HOOK

FORESTRY CHAIN G100 08X2500 + HOOK

FORESTRY CHAIN G100 08X3000 + HOOK

FORESTRY CHAIN G100 10X3000 + HOOK

FORESTRY CHAIN G100 10X3500 + HOOK



G80 forestry chain



G100 forestry chain

Cable slider for forestry chain.



Cable slider for forestry chain - swivel



Cable slider for forestry chain G100



FORESTRY WIRE ROPES AND CHAINS

Polyester slings

Naziv

Polyester roundsling 2T / 2M – 50 mm

Polyester roundsling 2T / 3M – 50 mm

Polyester roundsling 2T / 4M – 50 mm

Polyester roundsling 3T / 2M – 60 mm

Polyester roundsling 3T / 3M – 60 mm

Polyester roundsling 3T / 4M – 60 mm

Polyester roundsling 4T / 2M – 75 mm

Polyester roundsling 4T / 3M – 75 mm

Polyester roundsling 4T / 4M – 75 mm



Rope pulley

Item No.		Sheave Dia.	Capacity	A1(Hook)	A2(Shackle)	B	C	Wire Rope Dia.	N.W. (Hook)	N.W. (Shackle)	Product Code	
Hook	Shackle	mm	t	mm	mm	mm	mm	mm	kg	kg	Hook	Shackle
HB07502	SB07502	75	2	292	286	82	70	7-9	3.9	3.8		
HB11504	SB11504	115	4	358	345	120	70	10-12	6.2	6.2		
HB15004	SB15004	150	4	412	399	160	70	16-18	8.4	8.3		
HB15008	SB15008	150	8	498	475	160	93	20-22	14.1	14.1		
HB20008	SB20008	200	8	549	528	210	93	20-22	19	18.7		
HB20015	SB20015	200	15	672	663	210	102	22-24	34	33		
HB25010	SB25010	250	10	695	679	260	115	24-26	36	34.7		
HB25012	SB25012	250	12	701	679	260	115	24-26	36	34.7		
HB30012	SB30012	300	12	797	767	310	133	24-26	56	54		
HB30015	SB30015	300	15	800	788	310	133	24-26	58	55		
HB35522	SB35522	355	22	960	952	365	140	28-32	112	109		
HB40022	SB40022	400	22	1027	1019	415	140	28-32	122	118		
HB40030	SB40030	400	30	1085	1126	415	155	32-35	170	164		
HB50030	SB50030	500	30	1177	1256	514	162	32-35	213	208		
HB60050	SB60050	600	50	1445	1525	625	240	46-50	408	418		
HB76085	SB76085	760	85	1960	1910	800	288	56-64	810	840		



HB TYPE



SB TYPE

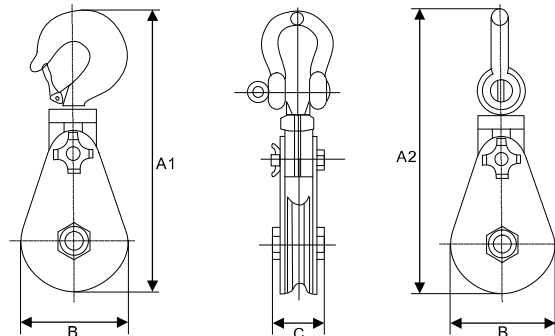

TURNBUCKLE

TURNBUCKLE OVERVIEW

GENERAL

A turnbuckle is a common rigging device for adjusting tension and reduce slack in ropes, cables and other tensioning systems. It normally consists of two threaded end fittings, one screwed into each end of a small metal frame, one with a left-hand thread and the other with a right-hand thread. The tension can be adjusted by rotating the frame, which causes both eye bolts to be screwed in or out simultaneously, without twisting the eye bolts or attached cables.



INSPECTION

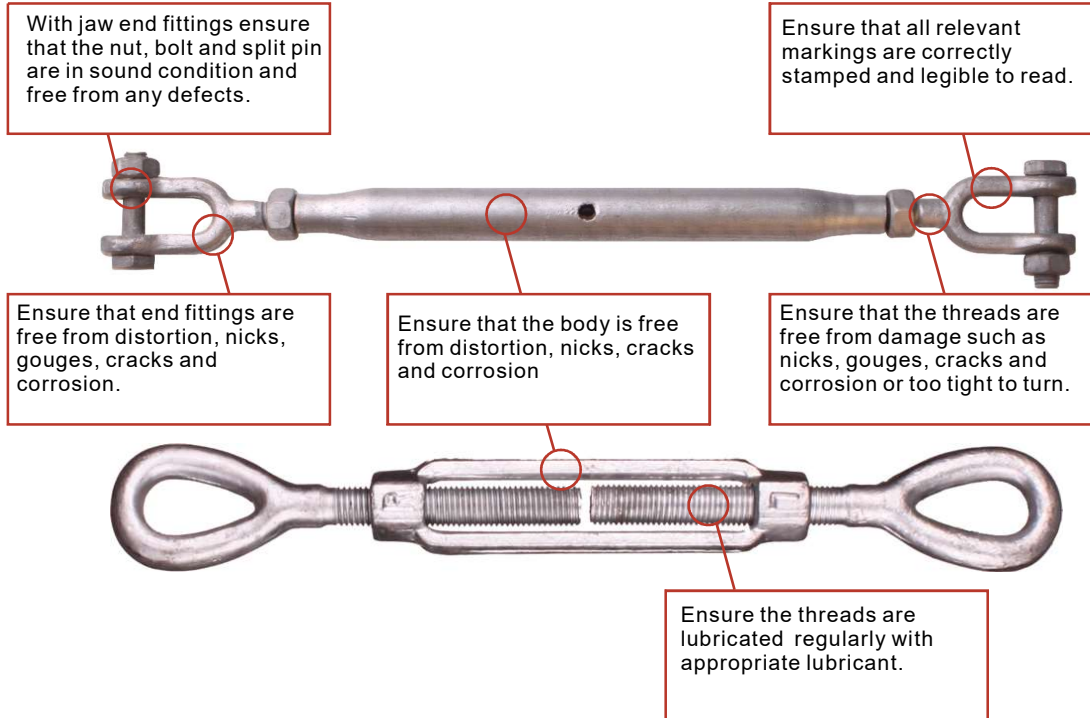

Care & Use

1. Make sure that the correct turnbuckle or rigging screw is selected for intended use and application.
2. Where components are connected to turnbuckle or rigging screw ensure they do not bind and freely articulate so that the system can sit in a straight line when tension is applied .
3. When tensioning the body of a turnbuckle or rigging screw ensure that both end terminals and fittings do not rotate.
4. Do not tension turnbuckles or rigging screws beyond the specified rating, especially for smaller sizes.
5. Turnbuckles and rigging screws are not designed for continuous adjustment under rated load conditions therefore wear on the threads should be checked if used in this way.
6. Locking nuts, fitted to the ends of the body, are a method of locking, but may not provide positive or reliable locking under all circumstances therefore should be inspected regularly.
7. Turnbuckles and rigging screws should be inspected periodically by a competent person.

TURNBUCKLE

TURNBUCKLE U.S. TYPE, DROP FORGED

1. Drop forged, quenched and tempered
2. Safety factor: 5:1
3. Proof load: 2.5 times the Working Load Limit
4. Finish: H.D.G., self colored or electro galvanized
5. End fitting: hook & hook, hook & eye, eye & eye, jaw & eye, jaw & jaw, stub end
6. Lock nuts available for all sizes.
7. Federal Specification FF-T-791b, Type 1, Form 1 and ASTM F1145-92
8. Note: turnbuckles are recommended for straight or in-line pull.

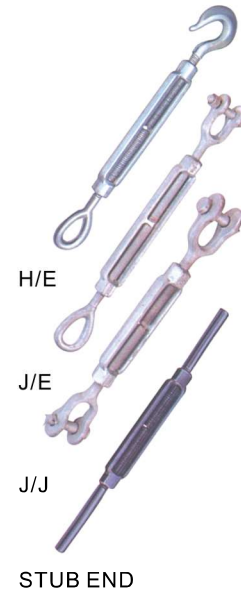

Item No.	Size/inch (Dia. & takeup)	W.L.L. (lbs)		Weight (lbs)				Product Code
		H&H H&E	E&E J&E J&J Stub End	E&E H&H E&H	JAW&EYE	Stub End	JAW&JAW	
TB106100	1/4 X 4	400	500	0.30	0.30	0.29	0.40	
TB108113	5/16 X 4-1/2	700	800	0.50	0.53	0.46	0.58	
TB110152	3/8 X 6	1000	1200	0.75	0.82	0.75	0.93	
TB113152	1/2 X 6	1500	2200	1.50	1.62	1.36	1.68	
TB113228	1/2 X 9	1500	2200	1.75	1.82	1.69	1.85	
TB113304	1/2 X 12	1500	2200	2.18	2.19	2.00	2.20	
TB116152	5/8 X 6	2250	3500	2.63	2.59	2.15	2.82	
TB116228	5/8 X 9	2250	3500	3.00	3.01	2.70	3.25	
TB116304	5/8 X 12	2250	3500	3.25	3.50	3.22	3.75	
TB119152	3/4 X 6	3000	5200	3.75	4.25	3.25	4.68	
TB119228	3/4 X 9	3000	5200	4.50	5.00	4.00	5.38	
TB119304	3/4 X 12	3000	5200	5.75	5.75	4.65	6.12	
TB119457	3/4 X 18	3000	5200	7.00	7.25	6.12	7.25	
TB122152	7/8 X 6	4000	7200	5.85	6.29	4.75	6.84	
TB122304	7/8 X 12	4000	7200	8.38	8.88	6.67	9.36	
TB122457	7/8 X 18	4000	7200	10.25	10.60	8.75	11.44	
TB125152	1 X 6	5000	10000	8.76	9.16	6.41	9.51	
TB125304	1 X 12	5000	10000	11.25	12.00	8.90	12.88	
TB125457	1 X 18	5000	10000	14.00	14.75	11.70	16.10	
TB125609	1 X 24	5000	10000	17.00	17.75	14.30	18.60	
TB132152	1-1/4 X 6	6500	15200	15.45	16.03	10.40	16.69	
TB132304	1-1/4 X 12	6500	15200	19.00	21.20	14.20	23.60	
TB132457	1-1/4 X 18	6500	15200	24.10	26.00	18.00	26.60	
TB132609	1-1/4 X 24	6500	15200	25.00	28.70	21.80	31.20	
TB138304	1-1/2 X 12	7500	21400	27.00	31.10	20.50	35.50	
TB138457	1-1/2 X 18	7500	21400	31.20	36.40	26.20	40.70	
TB138609	1-1/2 X 24	7500	21400	38.20	44.20	31.40	47.60	
TB144457	1-3/4 X 18	-	28000	45.20	48.80	/	52.40	
TB144609	1-3/4 X 24	-	28000	58.00	60.00	43.90	64.00	
TB150609	2 X 24	-	37000	90.00	102.00	60.30	115.00	
TB164609	2-1/2 X 24	-	60000	180.00	183.00	110.00	200.00	
TB170609	2-3/4 X 24	-	75000	210.00	214.00	/	248.00	

TURNBUCKLE

1. DIN 1480 turnbuckle: open body; DIN 1478 turnbuckle: closed body
2. Finish: electro galvanized, H.D.G. or self colored
3. End fitting: hook & hook, hook & eye, eye & eye, jaw & eye, jaw & jaw
4. Note: turnbuckles are not rated for lifting.

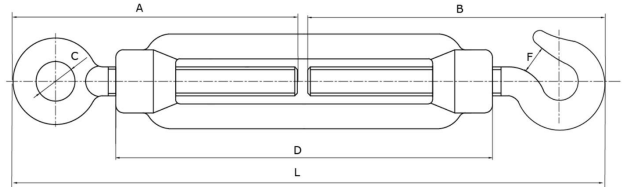

DIN 1480 TURNBUCKLE

Item No.	Size	Main Dimensions (mm)							Weight kg	Product Code
		D	L min	L max	A	C	B	F		
TB148005	M5	70	115	170	54	8.4	65	6	0.052	
TB148006	M6	110	166	250	80	10	85	8	0.09	
TB148008	M8	110	190	280	84	12	85	10.7	0.15	
TB148010	M10	125	216	305	105	14	112	13.2	0.26	
TB148012	M12	125	248	328	115	17.5	117	14.5	0.4	
TB148014	M14	140	254	343	122	18	122	15.5	0.6	
TB148016	M16	170	336	452	165	22	138	18	0.9	
TB148020	M20	200	365	485	167	25.5	170	20	1.65	
TB148022	M22	220	387	531	167	29.7	185	21.5	2.22	
TB148024	M24	255	437	612	205	27.7	205	24	2.68	
TB148027	M27	255	485	650	230	34	255	28.5	3.82	
TB148030	M30	255	520	670	255	36	255	29	4.5	
TB148032	M32	255	520	715	255	36	255	36	4.92	
TB148036	M36	295	576	754	276	44	255	43	8.3	



DIN 1478 TURNBUCKLE

Item No.	Size	W.L.L.	Body Length	Weight	Product Code
			mm	kg	
TB147806	M6	0.2T	110	0.2	
TB147808	M8	0.3T	110	0.4	
TB147810	M10	0.5T	125	0.6	
TB147812	M12	0.7T	125	0.9	
TB147816	M16	1.2T	170	1.3	
TB147820	M20	1.5T	200	1.7	
TB147822	M22	2.2T	220	3.2	
TB147824	M24	5T	255	3.9	
TB147833	M33	7T	295	7.3	
TB147836	M36	8T	295	8.5	
TB147839	M39	10T	330	10	
TB147850	M50	17T	356	21.5	



EYE BOLT

Eye bolt DIN580 and eye nut DIN582 are generally used as a removable lifting point where a rated female thread or nut can be utilized also can be used as a termination for chain, wire rope and other assemblies where required.

Material: C15 carbon steel as standard. C15E is optional.

Surface finish: electro galvanized

Safety factor: 6:1

With metric thread

Note: the eye bolt and nut must be of fully screwed in to achieve a perfect contact between the two mating faces.

DIN580 EYE BOLT

Item No.	Size	W.L.L. Ton	Dimensions (mm)				Weight kg	Product Code
	d		A	B	C	D		
HK2306	M6	0.08	20	36	20	13	0.05	
HK2308	M8	0.14	20	36	20	13	0.06	
HK2310	M10	0.23	25	45	25	17	0.11	
HK2312	M12	0.34	30	54	30	20.5	0.18	
HK2314	M14	0.49	35	63	35	27	0.28	
HK2316	M16	0.7	35	63	35	27	0.285	
HK2318	M18	0.93	40	72	40	30	0.45	
HK2320	M20	1.2	40	72	40	30	0.45	
HK2322	M22	1.5	45	81	45	35	0.67	
HK2324	M24	1.8	50	90	50	36	0.87	
HK2327	M27	2.5	50	90	50	36	0.88	
HK2330	M30	3.6	65	108	60	45	1.66	
HK2333	M33	4.3	65	108	60	45	1.72	
HK2336	M36	5.1	75	126	70	54	2.65	
HK2339	M39	6.1	75	126	70	54	2.8	
HK2342	M42	7	85	144	80	63	4.03	
HK2345	M45	8	85	144	80	63	4.25	
HK2348	M48	8.6	100	166	90	68	6.38	
HK2352	M52	9.9	100	166	90	68	6.6	
HK2356	M56	11.5	110	184	100	78	8.8	
HK2364	M64	16	120	206	110	90	12.4	

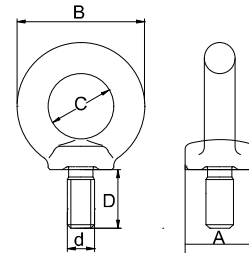

DIN582 EYE NUT

Item No.	Size	W.L.L. ton	Dimensions (mm)				Weight	Product Code
	d		A	B	C	D	kg	
HK2406	M6	0.08	20	36	20	8	0.045	
HK2408	M8	0.14	20	36	20	8	0.05	
HK2410	M10	0.23	25	45	25	10	0.09	
HK2412	M12	0.34	30	54	30	12	0.16	
HK2414	M14	0.49	35	63	35	14	0.24	
HK2416	M16	0.7	35	63	35	14	0.24	
HK2418	M18	0.93	40	72	40	16	0.36	
HK2420	M20	1.2	40	72	40	16	0.36	
HK2422	M22	1.5	45	81	45	18	0.58	
HK2424	M24	1.8	50	90	50	20	0.72	
HK2427	M27	2.5	50	90	50	20	0.7	
HK2430	M30	3.6	65	108	60	24	1.32	
HK2433	M33	4.3	65	108	60	24	1.3	
HK2436	M36	5.1	75	126	70	28	2.08	
HK2439	M39	6.1	75	126	70	28	2.02	
HK2442	M42	7	85	144	80	32	3.11	
HK2445	M45	8	85	144	80	32	3.04	
HK2448	M48	8.6	100	166	90	38	5.02	
HK2452	M52	9.9	100	166	90	38	4.95	
HK2456	M56	11.5	110	184	100	42	6.69	
HK2464	M64	16	120	206	110	48	9.3	

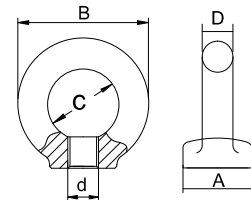

SHACKLE

SHACKLE OVERVIEW

General

Shackles are used in lifting static systems as removable links to connect wire rope, chain and other fittings. Shackles can be used in a variety of different applications, including:

Rigging
Towing or pulling
Lifting
Hoisting
Tie-down

Selecting the Correct Shackle

Shackles are available in a range of material grades, sizes and designs. Select the shackle to be used and plan the lift taking the following into account:

- Type of shackle: anchor / bow shackles vs. chain/dee shackles



Suitable for both one-leg and multi-leg systems



Suitable for one-leg systems only



Screw pin for quick (dis)assembly
Mainly used in non - permanent applications



Double safety (cotter pin & safety bolt)
Mainly used in long-term applications

- Type of pin: screw pin vs. bolt type

- Side loading: the following rated load reductions will occur when side loading angle deviates from in-line (0°)

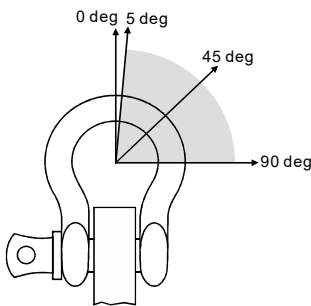

Side Loading Angle (°)	% of Rated Load Reduction
In-line (0° to 5°)	None
6°-45°	30%
46°-90°	50%
Over 90°	Not recommended

- Inspecting the shackles

- Inspect shackles regularly.
- Inspect the shackle eye and pin holes for stretching (elongation) and wear. Elongation means the metal is being overloaded.
- Inspect the shackle body for bending. A bent shackle indicates excessive side-loading.
- Inspect all shackle pins for distortion, surface blemishes, wear and fractures.
- All pins must be straight and all screw pins must be completely seated.

- Using shackles safely

- Do not force, hammer or wedge shackles into position.
- Do not exceed 120 degrees for the angle when using multiple leg slings.

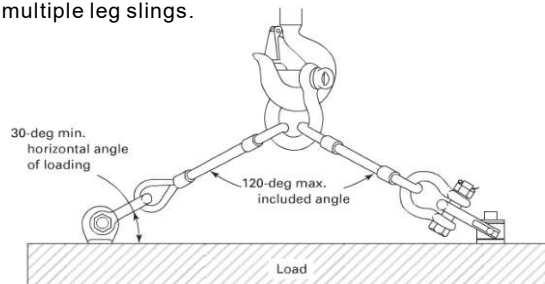

SHACKLE

Bow shackle can take loads from different directions and are perfectly suited for rigging due to their geometric shape.

- Forged, quenched and tempered.
- Material: body-carbon steel, pin-alloy steel
- Surface finish: electro galvanized body and painted pin as standard. Hot dip galvanized finish is optional.
- Safety factor: 6:1 as standard. 4:1 is optional.
- Marking: size, WLL, " CE " mark, batch number

NOTE: option:  NFC identification

SCREW PIN ANCHOR SHACKLE

Item No.	Size	W.L.L.	Dimensions(mm)						Weight kg	Product Code
			A	B	C	D	E	L		
SH01005	3/16"	1/3T	9.7	6.4	22.4	4.8	15.2	37.3	0.022	
SH01006	1/4"	1/2T	11.9	7.9	28.7	6.4	19.8	46.7	0.05	
SH01008	5/16"	3/4T	13.5	9.7	31	7.9	21.3	53	0.08	
SH01010	3/8"	1T	16.8	11.2	36.6	9.7	26.2	63	0.135	
SH01011	7/16"	1-1/2T	19.1	12.7	42.9	11.2	29.5	74	0.195	
SH01013	1/2"	2T	20.6	16	47.8	12.7	33.3	83.5	0.3	
SH01016	5/8"	3-1/4T	26.9	19.1	60.5	15.7	42.9	106	0.61	
SH01019	3/4"	4-3/4T	31.8	22.4	71.5	19.1	51	126	1.03	
SH01022	7/8"	6-1/2T	36.6	25.4	84	22.4	58	148	1.6	
SH01025	1"	8-1/2T	42.9	28.7	95.5	25.4	68.5	167	2.3	
SH01029	1-1/8"	9-1/2T	46	31.8	108	29.5	74	190	3.2	
SH01032	1-1/4"	12T	51.5	35.1	119	32.8	82.5	210	4.4	
SH01035	1-3/8"	13-1/2T	57	38.1	133	36.1	92	233	6.2	
SH01038	1-1/2"	17T	60.5	41.4	146	38.9	98.5	254	7.8	
SH01044	1-3/4"	25T	73	51	178	46.7	127	313	13.8	
SH01050	2"	35T	82.5	57	197	52.8	146	348	20.5	
SH01063	2-1/2"	55T	105	70	267	69.1	184	453	39	

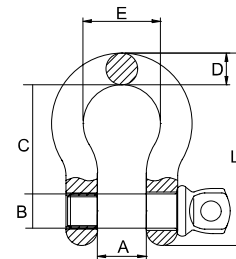

Spec. To RR-C-271,
Type 4A,
Grade A, Class 2
MIN. B.L. = 6 × WLL

BOLT TYPE ANCHOR SHACKLE

Item No.	Size	W.L.L.	Dimensions(mm)						Weight kg	Product Code
			A	B	C	D	E	L		
SH03005	3/16"	1/3T	9.7	6.4	22.4	4.9	15.2	37.3	0.03	
SH03006	1/4"	1/2T	11.9	7.9	28.7	6.4	19.8	46.7	0.075	
SH03008	5/16"	3/4T	13.5	9.7	31	7.9	21.3	53	0.1	
SH03010	3/8"	1T	16.8	11.2	36.6	9.7	26.2	63	0.16	
SH03011	7/16"	1-1/2T	19.1	12.7	42.9	11.2	29.5	74	0.215	
SH03013	1/2"	2T	20.6	16	47.8	12.7	33.3	83.5	0.36	
SH03016	5/8"	3-1/4T	26.9	19.1	60.5	16	42.9	106	0.7	
SH03019	3/4"	4-3/4T	31.8	22.4	71.5	19.1	51	126	1.23	
SH03022	7/8"	6-1/2T	36.6	25.4	84	22.4	58	148	1.8	
SH03025	1"	8-1/2T	42.9	28.7	95.5	25.4	68.5	167	2.78	
SH03029	1-1/8"	9-1/2T	46	31.8	108	28.7	74	190	3.75	
SH03032	1-1/4"	12T	51.5	35.1	119	31.8	82.5	210	5.31	
SH03035	1-3/8"	13-1/2T	57	38.1	133	35.1	92	233	6.98	
SH03038	1-1/2"	17T	60.5	41.4	146	38.1	98.5	254	9.4	
SH03044	1-3/4"	25T	73	51	178	44.5	127	313	15.4	
SH03050	2"	35T	82.5	57	197	51	146	348	23.7	
SH03063	2-1/2"	55T	105	70	267	66.5	184	453	39	
SH03075	3"	85T	127	82.5	330	76	200	546	70	
SH03088	3-1/2"	120T	133	95.5	372	92	229	626	120	
SH03100	4"	150T	140	108	368	104	254	653	158	

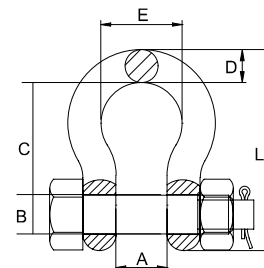

Spec. To RR-C-271,
Type 4A,
Grade A, Class 3
MIN. B.L. = 6 × WLL

SHACKLE

Chain shackle have a straight-legged shape that is optimized for two directions of pull. Most commonly used on single-leg slings.

- Forged, quenched and tempered.
- Material: body-carbon steel, pin-alloy steel
- Surface finish: electro galvanized body and painted pin as standard. Hot dip galvanized finish is optional.
- Safety factor: 6:1 as standard. 4:1 is optional.
- Marking: size, WLL, "CE" mark, batch number

NOTE: option:  NFC identification

SCREW PIN CHAIN SHACKLE

Item No.	Size	W.L.L.	Dimensions(mm)						Weight kg	Product Code
			A	B	C	D	E	L		
SH02005	3/16"	1/3T	9.7	6.4	19	4.8	19.4	33.9	0.022	
SH02006	1/4"	1/2T	11.9	7.85	22.4	6.35	24.6	40.4	0.05	
SH02008	5/16"	3/4T	13.5	9.65	26.2	7.85	29.5	48.5	0.08	
SH02010	3/8"	1T	16.8	11.2	31.8	9.65	35.8	58.5	0.13	
SH02011	7/16"	1-1/2T	19.1	12.7	36.6	11.2	41.4	67.5	0.19	
SH02013	1/2"	2T	20.6	16	41.4	12.7	46	77	0.27	
SH02016	5/8"	3-1/4T	26.9	19.1	51	16	58.5	95.5	0.57	
SH02019	3/4"	4-3/4T	31.8	22.4	60.5	19.1	70	115	1.02	
SH02022	7/8"	6-1/2T	36.6	25.4	71.5	22.4	81	135	1.43	
SH02025	1"	8-1/2T	42.9	28.7	81	25.4	93.5	151	2.15	
SH02029	1-1/8"	9-1/2T	46	31.8	91	28.7	103	172	3.06	
SH02032	1-1/4"	12T	51.5	35.1	100	31.8	115	191	4.11	
SH02035	1-3/8"	13-1/2T	57	38.1	111	35.1	127	210	5.28	
SH02038	1-1/2"	17T	60.5	41.4	122	38.1	137	230	7.23	
SH02044	1-3/4"	25T	73	51	146	44.5	162	279	12.13	
SH02050	2"	35T	82.5	57	172	51	184	312	19.2	
SH02063	2-1/2"	55T	105	70	203	66.5	238	377	32.5	

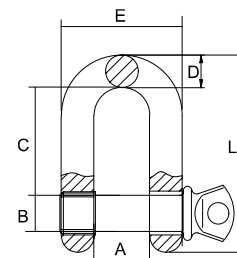

Spec.To RR-C-271,
Type 4B,
Grade A, Class 2
MIN.B.L.=6×WLL

BOLT TYPE CHAIN SHACKLE

Item No.	Size	W.L.L.	Dimensions(mm)						Weight kg	Product Code
			A	B	D	C	L	E		
SH04006	1/4"	1/2T	11.9	7.9	6.4	19.1	40.4	24.6	0.065	
SH04008	5/16"	3/4T	13.5	9.7	7.9	25.4	48.5	29.5	0.10	
SH04010	3/8"	1T	16.8	11.2	9.7	31	58.5	35.8	0.15	
SH04011	7/16"	1-1/2T	19.1	12.7	11.2	36.1	67.5	41.1	0.22	
SH04013	1/2"	2T	20.6	16	12.7	41.4	77	46	0.34	
SH04016	5/8"	3-1/4T	26.9	19.1	16	51	95.5	58.5	0.67	
SH04019	3/4"	4-3/4T	31.8	22.4	19.1	60.5	115	70	1.14	
SH04022	7/8"	6-1/2T	36.6	25.4	22.4	71.5	135	81	1.74	
SH04025	1"	8-1/2T	42.9	28.7	25.4	81	151	93.5	2.52	
SH04029	1-1/8"	9-1/2T	46	31.8	28.7	91	172	103	3.45	
SH04032	1-1/4"	12T	51.5	35.1	31.8	100	191	115	4.9	
SH04035	1-3/8"	13-1/2T	57	38.1	35.1	111	210	127	6.24	
SH04038	1-1/2"	17T	60.5	41.4	38.1	122	230	137	8.39	
SH04044	1-3/4"	25T	73	51	44.5	146	279	162	14.24	
SH04050	2"	35T	82.5	57	51	172	312	184	21.2	
SH04063	2-1/2"	55T	105	70	66.5	203	377	238	38.55	
SH04075	3"	85T	127	82.5	76	216	429	279	56.5	

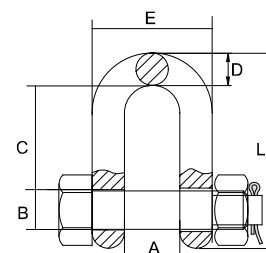

Spec.To RR-C-271,
Type 4B,
Grade A, Class 3
MIN.B.L.=6×WLL

SHACKLE

- For lifting application.
- Forged-quenched and tempered.

Material: alloy steel
 Proof load: 2.5 times the Working Load Limit
 Safety factor: 5 times of Working Load Limit
 Surface finish: self coloured / electro galvanized / H.D.G. / powder coated

NOTE: option:  NFC identification

GRADE 80 SCREW PIN ANCHOR SHACKLE, SBS TYPE

Item No.	Size	WLL	Main Dimensions(mm)					Weight	Product Code
		ton	A	C	D	B	L	kg	
8-SBS-08	5/16"	1.2	13.5	21.3	8	9.5	53	0.09	
8-SBS-10	3/8"	1.6	16.8	25.9	9.7	11	63.2	0.14	
8-SBS-11	7/16"	2.5	19	29.5	11.2	13	74	0.17	
8-SBS-13	1/2"	3.3	20.6	33.3	12.7	16	83.3	0.33	
8-SBS-16	5/8"	5	27	42.9	17.5	19	106.4	0.62	
8-SBS-19	3/4"	7	32	20.8	20.6	22	126.2	1.07	
8-SBS-22	7/8"	9.5	36.6	57.9	24.6	25	148	1.64	
8-SBS-25	1"	12.5	43	68.3	27	28	166.6	2.28	
8-SBS-28	1-1/8"	15	46	74	31.75	32	190	3.36	
8-SBS-32	1-1/4"	18	51.6	82.5	35	35	210	4.31	
8-SBS-35	1-3/8"	21	57	92	36	38	232.7	6.14	
8-SBS-38	1-1/2"	30	60.5	98	41	42	254	7.8	
8-SBS-44	1-3/4"	40	73.2	126	57.2	51	313.7	12.6	
8-SBS-50	2"	55	82.5	146	61	57	347.5	20.43	

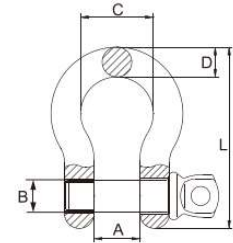

GRADE 80 SCREW PIN CHAIN SHACKLE, SDS TYPE

Item No.	Size	WLL	Main Dimensions(mm)				Weight	Product Code
		ton	A	D	L	B	kg	
8-SDS-08	5/16"	1.2	13.5	8	48.5	9.5	0.08	
8-SDS-10	3/8"	1.6	16.8	9.7	58.4	11	0.13	
8-SDS-11	7/16"	2.5	19	11.2	67.6	13	0.2	
8-SDS-13	1/2"	3.3	20.6	12.7	77	16	0.27	
8-SDS-16	5/8"	5	27	17.5	97.3	19	0.57	
8-SDS-19	3/4"	7	32	20.6	116.6	22	1.19	
8-SDS-22	7/8"	9.5	36.6	24.6	135.4	25	1.43	
8-SDS-25	1"	12.5	43	27	152.4	28	2.15	
8-SDS-28	1-1/8"	15	46	31.8	172.4	32	3.06	
8-SDS-32	1-1/4"	18	51.6	35	190.5	38	4.11	
8-SDS-35	1-3/8"	21	57	35	206.8	38	5.28	
8-SDS-38	1-1/2"	30	60.5	41	230.1	42	7.23	
8-SDS-44	1-3/4"	40	73.2	53.8	279	51	12.13	
8-SDS-50	2"	55	82.5	61	324.6	57	19.19	

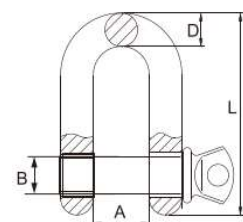

Manual Hoisting
Equipments

Electric Hoisting
Equipments

Textile Slings and
Height Safety

Transport and
Load Restraints

Lifting Chain/Chain
Slings/Components

Wire Rope/Wire Rope
Slings/Components

Forestry and
Rigging Hardware

Material Handling
Equipments

SHACKLE

- For lifting application.
- Forged-quenched and tempered.

Material: alloy steel
 Proof load: 2.5 times of Working Load Limit
 Safety factor: 5 times of Working Load Limit
 Surface finish: self coloured / electro galvanized / H.D.G. / powder coated

NOTE: option:  NFC identification

GRADE 80 BOLT TYPE ANCHOR SHACKLE, BBS TYPE

Item No.	Size	WLL ton	Main Dimensions(mm)							Weight kg	Product Code
			A	C	D	L	N	L1	B		
8-BBS-08	5/16"	1.2	13.5	21.3	8	53	9.5	50.5	8.4	0.1	
8-BBS-10	3/8"	1.6	16.8	25.9	9.7	63.2	11	62	10.8	0.15	
8-BBS-11	7/16"	2.5	19	29.5	11.2	74	13	70	12.8	0.22	
8-BBS-13	1/2"	3.3	20.6	33.3	12.7	83.3	16	79.5	14.8	0.46	
8-BBS-16	5/8"	5	27	42.9	17.5	106.4	19	101.5	18	0.73	
8-BBS-19	3/4"	7	32	51	20.6	126.2	22	117.5	19.4	1.1	
8-BBS-22	7/8"	9.5	36.6	57.9	24.6	148	25	136	21.5	1.79	
8-BBS-25	1"	12.5	43	68.3	27	166.6	28	153.5	23.8	2.57	
8-BBS-28	1-1/8"	15	46	74	31.75	190	32	171.5	25.6	3.75	
8-BBS-32	1-1/4"	18	51.6	82.5	35	210	35	192	31	5.31	
8-BBS-35	1-3/8"	21	57	92	36	232.7	38	202	33.4	7.18	
8-BBS-38	1-1/2"	30	60.5	98	41	254	42	222	34	9.43	
8-BBS-44	1-3/4"	40	73	126	57.2	313.7	51	278	38	13.38	
8-BBS-50	2"	55	82.5	146	61	347.5	57	307	45	23.7	

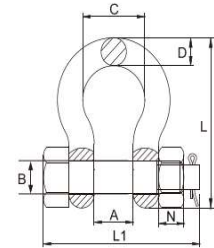

GRADE 80 BOLT TYPE CHAIN SHACKLE, BDS TYPE

Item No.	Size	WLL ton	Main Dimensions(mm)						Weight kg	Product Code
			A	D	B	L	L1	C		
8-BDS-08	5/16"	1.2	13.5	8	9.5	48.5	50.5	8.4	0.1	
8-BDS-10	3/8"	1.6	16.8	9.7	11	58.4	62	10.8	0.15	
8-BDS-11	7/16"	2.5	19.1	11.2	13	67.6	70	12.8	0.22	
8-BDS-13	1/2"	3.3	20.6	12.7	16	77	79.5	14.8	0.34	
8-BDS-16	5/8"	5	27	17.5	19	97.3	101.5	18	0.67	
8-BDS-19	3/4"	7	32	20.6	22	116.6	117.5	19.4	1.14	
8-BDS-22	7/8"	9.5	36.6	24.6	25	135.4	136	21.5	1.75	
8-BDS-25	1"	12.5	43	27	28	152.4	153.5	23.8	2.52	
8-BDS-28	1-1/8"	15	46	31.8	32	172.4	171.5	25.6	3.45	
8-BDS-32	1-1/4"	18	51.6	35	35	190.5	192	31	4.9	
8-BDS-35	1-3/8"	21	57	35	38	206.8	202	33.4	6.24	
8-BDS-38	1-1/2"	30	60.5	41	42	230.1	222	34	8.39	
8-BDS-44	1-3/4"	40	73	53.8	51	279	278	38	14.24	
8-BDS-50	2"	55	82.5	61	57	324.6	307	45	21.22	

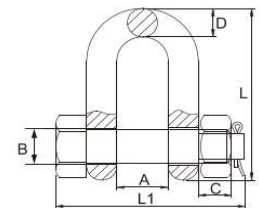

SHACKLE

EUROPEAN TYPE LARGE DEE SHACKLE

Item No.	Size	W.L.L.	Dimensions(mm)				Weight kg	Product Code
			A	B	C	D		
SH06005	5MM	0.08T	10	11	19	5	0.015	
SH06006	6MM	0.1T	13	14	25	6	0.024	
SH06008	8MM	0.2T	16	18	32	8	0.05	
SH06010	10MM	0.32T	19	20	38	10	0.085	
SH06012	12MM	0.52T	25	26	51	12	0.17	
SH06014	14MM	0.7T	28	28	56	14	0.25	
SH06016	16MM	0.8T	32	33	64	16	0.38	
SH06018	18MM	1T	36	35	72	18	0.59	
SH06020	20MM	1.1T	38	40	76	20	0.76	
SH06022	22MM	1.5T	44	50	89	22	1.05	
SH06025	25MM	2.1T	51	57	100	25	1.55	
SH06028	28MM	3T	57	68	115	28	2.25	
SH06032	32MM	3.5T	64	73	127	32	3.35	
SH06036	36MM	4T	72	75	144	36	4.6	
SH06038	38MM	5T	76	85	152	38	5.86	
SH06042	42MM	6T	84	90	168	42	7.9	
SH06045	45MM	7T	90	96	180	45	10	
SH06050	50MM	8T	102	108	200	50	12.5	

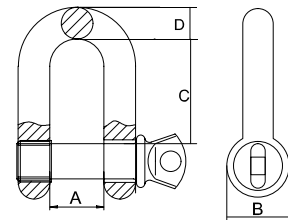

SHACKLE DIN 82101 FORM A

Form A: Dee shackle with screw collar pin.

Material: carbon steel, drop forging.

Safety Factor: Minimum Breaking Load (MBL) is generally five times the Working Load Limit (WLL).

Finish: hot-dipped galvanized or zinc plated or self-colored finishes.

NOTE: option:  NFC identification

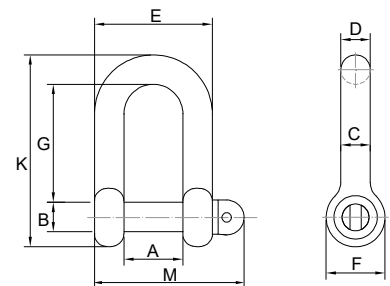

Item No.	Size	W.L.L.	Dimensions(mm)									Weight kg	Product Code
			A	B	C	D	E	F	G	K	M		
SH07005	M5	0.1T	7	5	4	5	15	10	15	28	23	0.013	
SH07006	M6	0.16T	8	6	5	6	18	12	18	33	26.5	0.021	
SH07008	M8	0.25T	11	8	7	8	25	16	23.5	44	33.5	0.048	
SH07010	M10	0.4T	14	10	8	10	30	20	29.5	55	41	0.083	
SH07012	M12	0.6T	17	12	10	12	37	24	35.5	66	50	0.156	
SH07016	M16	1T	21	16	13	15	47	32	48.5	88	62	0.33	
SH07020	M20	1.6T	27	20	17	19	61	40	60.5	110	82	0.71	
SH07022	M22	2T	30	22	19	21	68	44	66.5	121	90	0.94	
SH07024	M24	2.5T	33	24	21	23	75	48	72.5	132	99	1.35	
SH07027	M27	3T	38	27	24	26	86	54	83	150	115	1.89	
SH07030	M30	4T	42	30	27	29	96	60	90.5	165	125	2.53	
SH07036	M36	5T	47	36	30	33	107	72	110.5	198	139	4	
SH07039	M39	6T	53	39	34	37	121	78	119	215	154.5	5.1	
SH07045	M45	8T	60	45	38	41	136	90	138.5	248	175.5	7.92	
SH07048	M48	10T	66	48	42	45	150	96	146	264	195	9.87	
SH07052	M52	12T	73	52	47	50	167	104	157	284	211	13.68	
SH07060	M60	16T	81	60	52	55	185	120	183.5	330	232	20.23	
SH07068	M68	20T	90	68	58	61	206	136	209.5	374	259	28.51	
SH07072	M72	25T	100	72	63	67	226	144	219.5	396	284	33.93	



SHACKLE

SHACKLE DIN 82101 FORM C

Form C: Dee shackle with safety bolt, nut, and cotter pin.

Material: carbon steel, drop forging.

Safety Factor: Minimum Breaking Load (MBL) is generally five times the Working Load Limit (WLL).

Finish: hot-dipped galvanized or zinc plated or self-colored finishes.

NOTE: option:  NFC identification

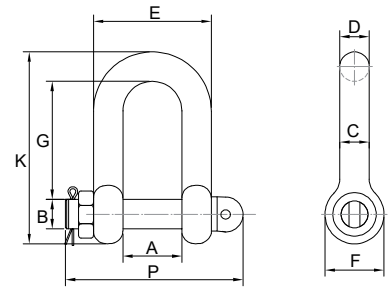

Item No.	Size	W.L.L.	Dimensions(mm)									Weight kg	Product Code
			A	B	C	D	E	F	G	K	P		
SH08010	M10	0.4T	14	10	8	10	30	20	29.5	55	58	0.097	
SH08012	M12	0.6T	17	12	10	12	37	24	35.5	66	68	0.181	
SH08016	M16	1T	21	16	13	15	47	32	48.5	88	81	0.369	
SH08020	M20	1.6T	27	20	17	19	61	40	60.5	110	104	0.788	
SH08022	M22	2T	30	22	19	21	68	44	66.5	121	115	1.01	
SH08024	M24	2.5T	33	24	21	23	75	48	72.5	132	127	1.458	
SH08027	M27	3T	38	27	24	26	86	54	83	150	145	2.05	
SH08030	M30	4T	42	30	27	29	96	60	90.5	165	156	2.72	
SH08036	M36	5T	47	36	30	33	107	72	110.5	198	172	4.2	
SH08039	M39	6T	53	39	34	37	121	78	119	215	189	5.66	
SH08045	M45	8T	60	45	38	41	136	90	138.5	248	211	8.45	
SH08048	M48	10T	66	48	42	45	150	96	146	264	240	10.8	
SH08052	M52	12T	73	52	47	50	167	104	157	284	254	14.23	
SH08060	M60	16T	81	60	52	55	185	120	183.5	330	285	21.93	
SH08068	M68	20T	90	68	58	61	206	136	209.5	374	316	31.18	
SH08072	M72	25T	100	72	63	67	226	144	219.5	396	341	36.73	
SH08080	M80	32T	110	80	70	74	250	160	244.5	440	369	50	
SH08090	M90	40T	125	90	79	84	283	180	274	495	409	71	
SH08100	M100	50T	140	100	88	93	316	200	307	550	462	97.08	



COMMERCIAL CHAIN



DIN 763 LINK CHAIN

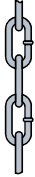

Item No.	Size / A mm	B mm	C mm	W.L.L. kg	B.L. kN	WT./M kg	Product Code
C-76304	4	32	16	100	6	0.27	
C-76305	5	35	20	160	10	0.43	
C-76306	6	42	24	200	12.5	0.63	
C-76307	7	49	28	300	18	0.86	
C-76308	8	52	32	400	25	1.10	
C-76310	10	65	40	630	40	1.75	
C-76313	13	82	52	1000	63	2.95	
C-76316	16	100	64	1600	100	4.45	
C-76320	20	120	75	2500	160	7.00	

DIN 764 LINK CHAIN



Item No.	Size / A	B	C	B.L.	W.T./M	Product Code
	mm	mm	mm	kN	kg	
C-76404	4	16	14	7	0.31	
C-76405	5	18	18.2	11.8	0.51	
C-76406	6	21	21.5	16.5	0.74	
C-76408	8	28	29	32	1.32	
C-76410	10	35	36	50	2	
C-76412	12	42	41	70	2.98	
C-76413	13	45	47	80	3.5	
C-76414	14	49	48	92	4.06	
C-76416	16	56	58	125	5.2	
C-76418	18	63	65	160	6.5	
C-76420	20	70	72	200	8.2	
C-76423	23	80	83	250	11	
C-76426	26	91	94	320	14	

DIN 766 LINK CHAIN



Item No.	Size / A mm	B mm	C mm	W.L.L. kN	B.L. kN	WT./M kg	Product Code
C-76604	4	16	14.2	2.0	8.0	0.32	
C-76605	5	18.5	17	3.2	12.5	0.50	
C-76606	6	18.5	20.4	4.0	16.0	0.80	
C-76607	7	22	23.8	6.3	25.0	1.10	
C-76608	8	24	27.2	8.0	32.0	1.40	
C-76609	9	27	30.6	10.0	40.0	1.80	
C-76610	10	28	36	12.5	50.0	2.20	
C-76611	11	31	37.4	16.0	63.0	2.70	
C-76613	13	36	44.2	20.0	80.0	3.80	
C-76614	14	41	47.6	25.0	100.0	4.40	
C-76616	16	45	54.4	32.0	125.0	5.70	
C-76618	18	50	61.2	40.0	160.0	7.30	
C-76620	20	56	68	50.0	200.0	9.00	

DIN 5685 SHORT LINK CHAIN



Item No.	Size / A mm	B mm	C mm	W.L.L. kN	B.L. kN	WT./M kg	Product Code
C-S568503	3	16	11	1.12	2.8	0.16	
C-S568504	4	19	15	2.0	5.0	0.30	
C-S568505	5	21	19	3.15	7.75	0.50	
C-S568506	6	24	23	4.5	11.5	0.73	
C-S568507	7	28	27	6.0	15.0	1.00	
C-S568508	8	32	31	8.0	20.0	1.30	
C-S568509	9	36	35	10.0	25.0	1.65	
C-S568510	10	40	39	12.5	31.0	2.05	
C-S568511	11	44	43	15.0	38.0	2.50	
C-S568512	12	48	47	18.0	45.0	2.90	
C-S568513	13	52	51	21.2	53.0	3.45	

MOVING SKATE & RACK JACK

MOVING SKATE CTXY TYPE

Features

- Ideal for moving industrial machine and heavy loads.
- One set consists of one front steerable skate (X serie) and two rear skates (Y serie).
- X serie steerable skate allows the load to change direction whilst being moved.
- Y serie rear skates are held in line with a tie rod.

Item No.	Capacity	Description		Load Plate Area Size	Handle Length	Tie Rod, Adjustable	Skate Size	Weight	Product Code
	t			mm	mm	mm	L×W×H (mm)	kg	
CTXY08	8	X4 + Y4	X4	Φ150	1020	260-1000	230×220×113	28	
		Y4	Y4	130×130			170×130×113		
CTXY16	16	X8 + Y8	X8	Φ160	1130	490-1700	493×527×113	71	
		Y8	Y8	200×160			200×195×113		
CTXY24	24	X12 + Y12	X12	Φ180	1130	650-1780	536×748×113	99	
		Y12	Y12	280×180			280×200×113		
CTXY32	32	X16 + Y16	X16	Φ200	1300	650-2000	560×899×113	129	
		Y16	Y16	339×175			204×339×113		
CTXY36	36	X18 + Y18	X18	Φ200	1300	650-2080	616×762×113	145	
		Y18	Y18	280×270			300×280×113		
CTXY48	48	X24 + Y24	X24	Φ220	1600	730-1320	684×882×162	242	
		Y24	Y24	330×200			230×330×162		
CTXY64	64	X32 + Y32	X32	Φ 250	1600	930-2420	690×1103×169	315	
		Y32	Y32	420×220			230×420×169		



RACK JACK RJ TYPE

Item No.	Capacity	Proof Load	Effort Required to Lift Rated Load	Stroke	Min. Lifting Height (mm)		Dimensions (mm)										N.W.	Product Code
	t	kN	N	mm	F	H	A	B	C	D	E	G	K	R	kg			
RJ015	1.5	18.4	150	300	60	600	163	190	273	100	55	110	113	225	13.5			
RJ030	3	36.8	280	350	70	730	197	200	296	130	60	140	127	250	21.2			
RJ050	5	61.3	280	350	80	730	189	239	335	140	71	170	127	275	28.5			
RJ100	10	122.5	560	410	85	800	250	293	498	140	86	170	248	300	46.8			
RJ160	16	196	640	320	95	800	275	320	514	150	78	180	250	300	65			
RJ200	20	245	640	320	100	860	275	335	529	150	78	180	250	380	75			



Safety ratchet crank available upon request.

Features

- Mechanical jack for working in vertical position.
- Operation with foldable handle.
- Supporting parts are extra hardened.
- Two safety pawls for controlled descent.
- With safety locking mechanism.
- Tested with 25% overload.
- Capacity on the toe is 70% of the WLL for RJ160 and RJ200.

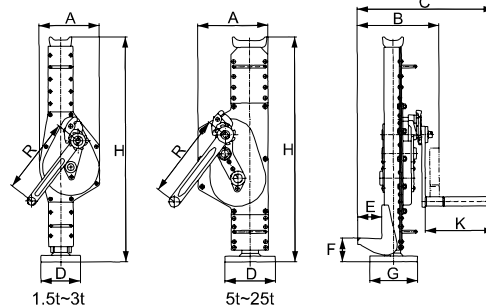

HAND PALLET TRUCK

Hydraulic hand pallet truck is the most basic tool used to lift and move pallet.

HYDRAULIC PALLET TRUCK PT-BF TYPE



Features

- Robust frame structure and reinforced fork design for additional strength and durability.
- Ergonomically designed rubber grip handle for easy handling.
- Integral casting pump design.
- 210 degrees steering arc, and small turning radius.
- Equipped with over-load valve.
- Forks lowering speed is controllable.
- Option: nylon wheel, polyurethane wheel, rubber wheel, single fork roller or tandem fork rollers.

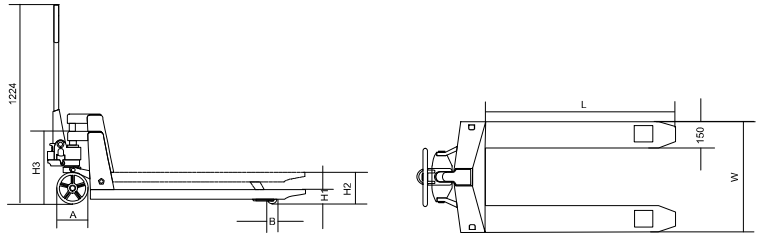

Item No.	Capacity t	Lowered Fork Height	Total Lift Height	Height of Handleless	Fork Length	Width Over the Forks	Fork Wheel	Steering Wheel	Product Code
		H1 mm	H2 mm	H3 mm	L mm	W mm	B mm	A mm	
PT-BF525	2.5	75/85	190/200	431.5	1100/1150/1220	540	75/80	180/200	
PT-BF625	2.5	75/85	190/200	431.5	1100/1150/1220	685	75/80	180/200	
PT-BF530	3	75/85	190/200	431.5	1100/1150/1220	540	75/80	180/200	
PT-BF630	3	75/85	190/200	431.5	1100/1150/1220	685	75/80	180/200	

HYDRAULIC HAND PALLET TRUCK WITH SCALE

Features

Hydraulic hand pallet truck with scale is with built-in digital scales and designed for pallet lifting, transporting and weighing cargo load instead of transferring to a platform scale.

- Easy-to-read backlit LCD display.
- Power supply with rechargeable battery or with 86~264V AC input.
- Keypad and automatic tare functions.
- Available in pounds or kilograms.



PT-BFC



PT-BFS

Item No.	Capacity	Total Lift Height	Lowered Fork Height	Fork Length	Width Over the Forks	Steering Wheel	Fork Wheel	Truck Weight	Product Code
	t	mm	mm	mm	mm	mm	mm	kg	
PT-BFC20	2	205	85	1150	540	160	70	115	
PT-BFS20	2	175	85	1150	540	160	70	112	

TOE JACK

ROTATIONAL TOE JACK, RTJ TYPE

Features

- Compact and stable construction.
- Can be used in any position.
- Housing revolves 360 degrees.
- Lowering speed can be accurately adjusted.
- Protected against overloading.
- Pump lever is removable.
- According to CE safety standard.

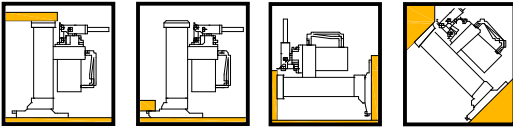

RTJ05
5 t

RTJ10
10 t

RTJ25
25 t

Item No.	Rated Capacity	Lift Height on Toe	Lift Height on Head	Max. Lever Force	Weight	Product Code
	t	mm	mm	kg	kg	
RTJ05	5	25 ~ 230	368 ~ 573	38	25	
RTJ10	10	30 ~ 260	420 ~ 650	40	35	
RTJ25	25	58 ~ 273	505 ~ 720	40	102	

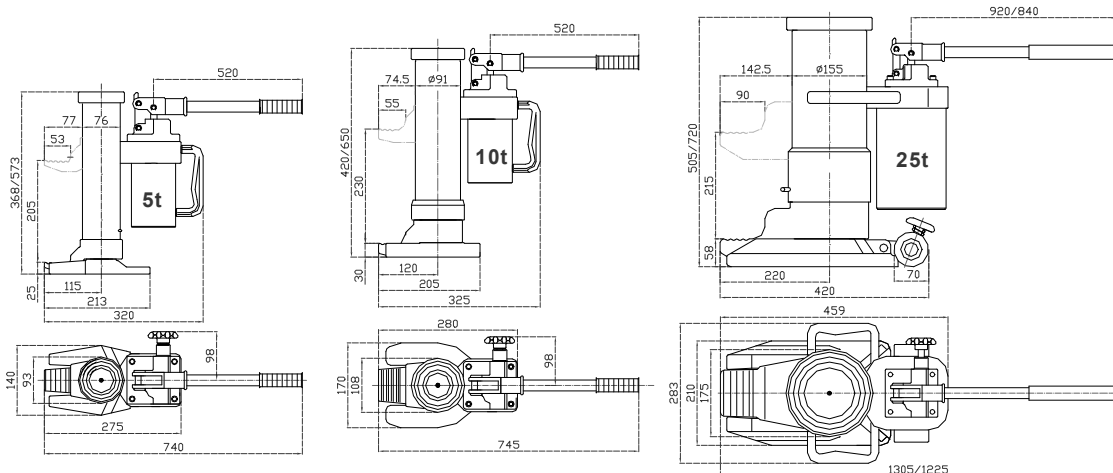

TOE JACK & HYDRAULIC BOTTLE JACK

MACHINERY TOE JACK, MTJ TYPE

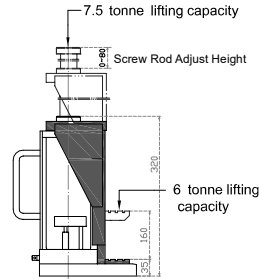

MTJ06

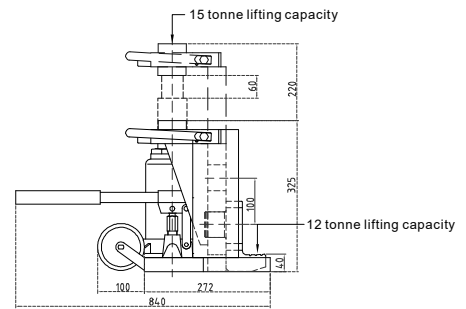

MTJ12

Features

- Used to lift heavy objects from a low height.
- Two lifting position (toe and top) for different capacity.
- Safety valve for overload protection.
- Adjustable lowering speed.
- Removable pump handle.

Item No	Rated Capacity on Toe	Rated Capacity on Head	Lift Height on Toe	Lift Height on Head	Lifting Stroke	Screw Rod Adjust Height	Weight	Product Code
	t	t	mm	mm	mm	mm	kg	
MTJ06	6	7.5	35~195	320~560	160	0 ~ 80	25	
MTJ12	12	15	40~180	325~465	140	~	68	

Features

Ideal for lifting farm vehicles, heavy-duty machinery, industrial construction equipment, etc.

- Compact and stable construction.
- High-quality, glide-action pressure pump designed to lift with minimum effort.
- Two-piece pump handle for easy use in tight spaces and compact storage.
- Tough heat-treated extension screw.
- Wide base for improved stability.
- BJE type is with safety overload valve and complies with EU standard. BJA type complies with American standard.



BJE TYPE
with safety valve

HYDRAULIC BOTTLE JACK, BJE TYPE

Item No.	Capacity	Min. Height	Lifting Range	Adjust. Height	Max. Height	Weight	Product Code
	t	mm	mm	mm	mm	kg	
BJE002	2	148	80	50	278	2.3	
BJE003	3	178	105	60	343	3.1	
BJE005	5	185	113	60	358	3.9	
BJE008	8	185	105	60	350	4.6	
BJE010	10	190	110	60	360	5.3	
BJE012	12	190	100	60	350	6.3	
BJE015	15	190	105	60	355	7.1	
BJE020	20	190	95	60	345	9.3	
BJE030	30	220	115	/	335	11.8	
BJE050	50	260	140	/	400	27.5	

FARM JACK

FARM JACK, FJ TYPE

Features

- Ideal for loading and off-loading vehicles, moving heavy objects, tensioning of wire fences, removing tree stumps, and much more.
- Reversible ratchet mechanism enables jack to be used for lifting or lowering.
- Upper jaw is adjustable on beam, allowing jack to be used as a clamp.
- Versatile and lightweight.

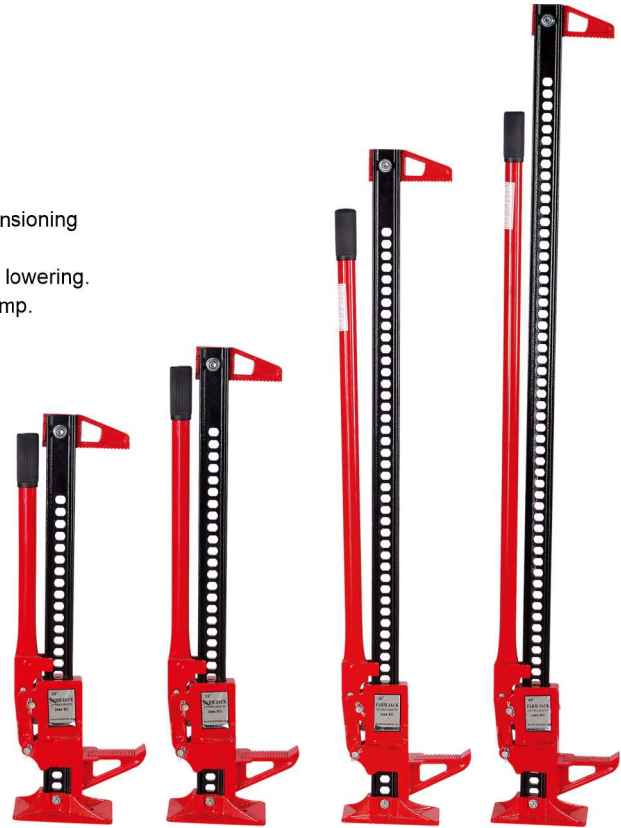

FJ-20

FJ-33

FJ-48

FJ-60

Item No.	Size	Capacity	Min. Height	Lifting Height	Max. Height	Weight	Product Code
	inch		mm	mm	mm	kg	
FJ-20	20	3	115	230	345	8.5	
FJ-33	33	3	115	545	660	11.8	
FJ-48	48	3	115	915	1030	12.9	
FJ-60	60	3	115	1185	1300	13.5	

CRANE FORK & ENGINE CRANE

SELF WEIGHT BALANCE CRANE FORK, CFB TYPE

Features

- CFB type crane fork requires no manual intervention to level the load.
- Equipped with adjustable tines, adjustable mast height and a self weight balancing system.
- A prerequisite for the functionality is an even load distribution and a useful load of at least 25% of the load bearing capacity.
- Crane forks with self weight balancing, tend to point their tines upwards when being transported, this prevents the load from unintentionally slipping off the tines. The self-weight balancing mechanism returns the lifting point to the unloaded position when the load is set down.
- Safety factor: 4:1



Item No.	Lifting Capacity	Adjusting Range	Effective Height	Fork Length	Fork Cross Section	Height	Weight	Product Code
	t	A mm	B mm	C mm	D mm	E mm	kg	
CFB010	1	350 - 900	1100 - 1600	1000	100 x 30	1420 - 1920	140	
CFB015	1.5	350 - 900	1300 - 2000	1000	100 x 40	1650 - 2350	165	
CFB020	2	400 - 900	1300 - 2000	1000	120 x 40	1655 - 2355	220	
CFB030	3	450 - 900	1300 - 2000	1000	120 x 50	1720 - 2420	280	
CFB050	5	530 - 1000	1300 - 2000	1000	150 x 60	1710 - 2410	380	

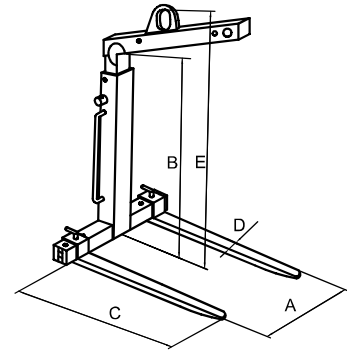

ENGINE CRANE, ECA TYPE



Item No.	Capacity	Dimensions											Weight kg	Product Code
	P1/P2/P3 kg	A mm	B mm	C mm	D mm	E mm	F mm	G mm	H mm	I mm	W mm	K mm		
	ECA0500	500/425/350	1354	165	1582	897	102	2080	1920	130	330	470		
ECA1000	1000/800/700	1597	90	1749	1231	150	2450	2320	/	280	460	1100	115	
ECA2000	2000/1700/1500	1626	208	1911	1293	150	2700	2500	/	250	590	1170	165	

Features

- Ideal for use in home workshops and garages.
- Three hook positions give different load ratings whilst enabling a longer or shorter reach.
- Overload protection via a relief valve.
- Forged heavy duty swivel hook.
- 125% overload test applied.

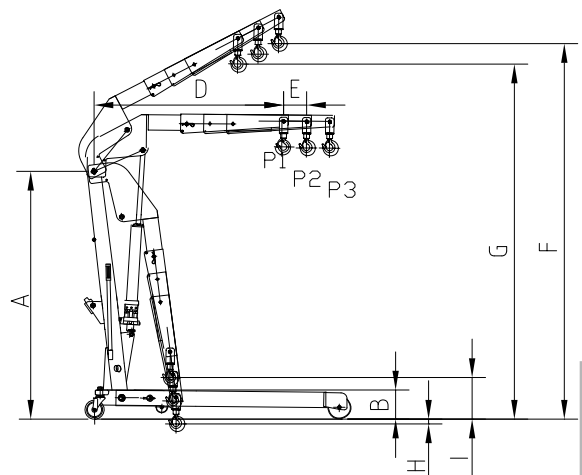
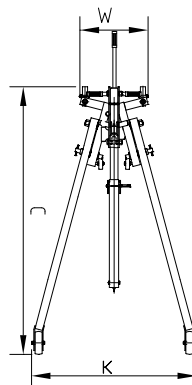
 Manual Hoisting
Equipments

 Electric Hoisting
Equipments

 Textile Sling and
Height Safety

 Transport and
Load Restraints

 Lifting Chain/Chain
Sling/Components

 Wire Rope/Wire Rope
Sling/Components

 Forestry and
Rigging Hardware

 Material Handling
Equipments

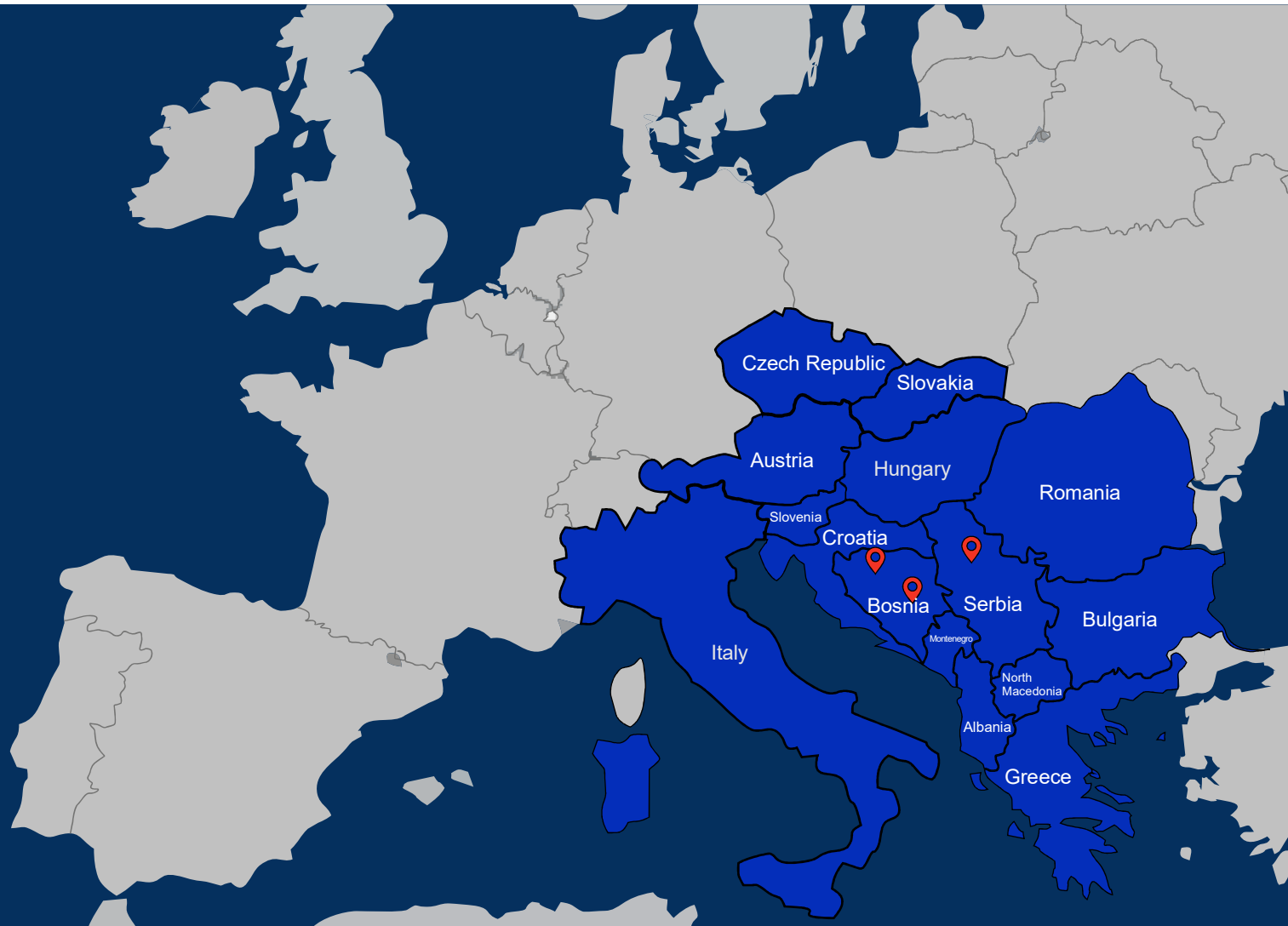

Beograd - SRB

HF Lifting d.o.o

**Pozovite nas
+381 (0) 69 708 358**

**Email
info@hflifting.rs**

**Adresa
Žitna 28, Dobanovci - Beograd
Srbija**

Laktaši- BIH

Hidraulika-Flex d.o.o.

**Pozovite nas
+387 (0)51 259 360**

**Email
info@hidraulikaflex.com**

**Adresa
Jovana Cvijića 3, 78250 Laktaši,
Bosna i Hercegovina**

Sarajevo- BIH

Hidraulika - flex SA d.o.o

**Pozovite nas
+387 (0)33 743 905**

**Email
info@hidraulikaflexsa.ba**

**Adresa
Kurta Schorka 8, 71000 Sarajevo ,
Bosna i Hercegovina**

