

ŠKOPCI

INFORMACIJE

Opšti podaci

Škopci se koriste u statičnim sistemima za podizanje kao uklonjivi elementi za povezivanje čeličnih sajli, lanaca i drugih priključaka. Škopci se mogu koristiti u raznim aplikacijama, uključujući:

Montaža i zatezanje (Rigging)
 Vuča ili izvlačenje (Towing or pulling)
 Dizanje (Lifting)
 Podizanje (Hoisting)
 Osiguranje tereta (Tie-down)

Izbor odgovarajućeg škopca

Škopci su dostupni u različitim materijalnim kvalitetima, veličinama i dizajnim. Izaberite škopac za upotrebu i planirajte dizanje uzimajući u obzir sledeće:

• Tip škopca: trbušasti (lukasti) škopci naspram ravnih (dee) škopaca



Pogodno za jednokraku i višekraku opremu/sisteme.



Pogodno samo za jednokrake sisteme.

Tip osovine: navojna osovina naspram osovine sa vijkom (bolt tip)



Navojna osovina za brzo sastavljanje i rastavljanje
 Pretežno se koristi u nepovoljnim primenama



Dvostruka sigurnost (osigurač i sigurnosni vijak)
 Pretežno se koristi u dugoročnim primenama

Bočno opterećenje: sledeća smanjenja dozvoljenog opterećenja će se javiti kada ugao bočnog opterećenja odstupa od pravolinijskog (0°)

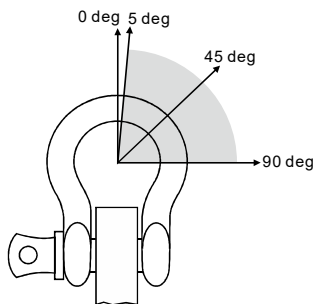

Side Loading Angle (°)	% of Rated Load Reduction
In-line (0° to 5°)	None
6°-45°	30%
46°-90°	50%
Over 90°	Not recommended

- Pregled škopaca - inspekcija

- Redovno pregledati škopce.
- Pregledati oko škopca i otvore za osovinu na istezanje (produženje) i habanje.
- Produženje znači da je metal preopterećen.
- Pregledati telo škopca na savijenost.
- Savijen škopac ukazuje na prekomerno bočno opterećenje.
- Pregledati sve osovine škopca na deformacije, oštećenja površine, habanje i pukotine.
- Sve osovine moraju biti ravne, a sve navojne osovine potpuno zategnute.

- Bezbedno korišćenje škopaca

- Ne forsirati, čekićem ili klinom ubacivati škopce u položaj.
- Ne prelaziti ugao od 120 stepeni pri upotrebi višekrakah priveznica

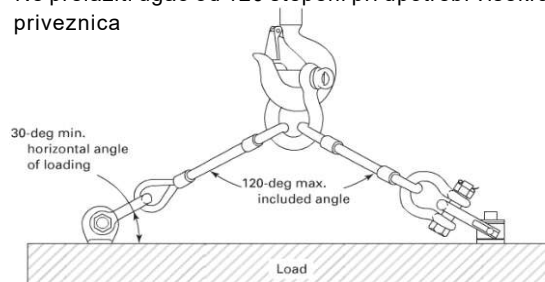

Ručna oprema za podizanje tereta
 Električna oprema za podizanje tereta
 Poliesterske priveznice
 Transportne trake za osiguranje tereta
 Lanac, lančane priveznice i komponente
 Čelična užad, priveznice i komponente
 Oprema za šumarstvo
 Oprema za premeštanje tereta

Trbušasti škopac može da podnosi opterećenja iz različitih pravaca i zbog svog geometrijskog oblika idealan je za montažu i zatezanje.

– Kovan, kaljen i toplotno obrađen.

Materijal: telo – ugljenični čelik, osovina – legirani čelik

Završna obrada: telo elektrogalvanizovano, osovina farbana (standard); vruće pocinčana obrada opciono

Faktor sigurnosti: 6:1 kao standard; 4:1 opciono

Označavanje: dimenzija, WLL, «CE» oznaka, broj serije

NAPOMENA: opciono  NFC identifikacija

TRBUŠASTI ŠKOPAC TIP «A»

Šifra	Veličina	Nosivost (t)	Dimenzije (mm)						Težina kg	Product Code
			A	B	C	D	E	L		
SH01005	3/16"	1/3T	9.7	6.4	22.4	4.8	15.2	37.3	0.022	
SH01006	1/4"	1/2T	11.9	7.9	28.7	6.4	19.8	46.7	0.05	
SH01008	5/16"	3/4T	13.5	9.7	31	7.9	21.3	53	0.08	
SH01010	3/8"	1T	16.8	11.2	36.6	9.7	26.2	63	0.135	
SH01011	7/16"	1-1/2T	19.1	12.7	42.9	11.2	29.5	74	0.195	
SH01013	1/2"	2T	20.6	16	47.8	12.7	33.3	83.5	0.3	
SH01016	5/8"	3-1/4T	26.9	19.1	60.5	15.7	42.9	106	0.61	
SH01019	3/4"	4-3/4T	31.8	22.4	71.5	19.1	51	126	1.03	
SH01022	7/8"	6-1/2T	36.6	25.4	84	22.4	58	148	1.6	
SH01025	1"	8-1/2T	42.9	28.7	95.5	25.4	68.5	167	2.3	
SH01029	1-1/8"	9-1/2T	46	31.8	108	29.5	74	190	3.2	
SH01032	1-1/4"	12T	51.5	35.1	119	32.8	82.5	210	4.4	
SH01035	1-3/8"	13-1/2T	57	38.1	133	36.1	92	233	6.2	
SH01038	1-1/2"	17T	60.5	41.4	146	38.9	98.5	254	7.8	
SH01044	1-3/4"	25T	73	51	178	46.7	127	313	13.8	
SH01050	2"	35T	82.5	57	197	52.8	146	348	20.5	
SH01063	2-1/2"	55T	105	70	267	69.1	184	453	39	

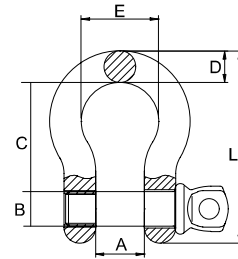

TRBUŠASTI ŠKOPAC TIP «C»

Šifra	Veličina	Nosivost (t)	Dimenzije (mm)						Težina kg	Product Code
			A	B	C	D	E	L		
SH03005	3/16"	1/3T	9.7	6.4	22.4	4.9	15.2	37.3	0.03	
SH03006	1/4"	1/2T	11.9	7.9	28.7	6.4	19.8	46.7	0.075	
SH03008	5/16"	3/4T	13.5	9.7	31	7.9	21.3	53	0.1	
SH03010	3/8"	1T	16.8	11.2	36.6	9.7	26.2	63	0.16	
SH03011	7/16"	1-1/2T	19.1	12.7	42.9	11.2	29.5	74	0.215	
SH03013	1/2"	2T	20.6	16	47.8	12.7	33.3	83.5	0.36	
SH03016	5/8"	3-1/4T	26.9	19.1	60.5	16	42.9	106	0.7	
SH03019	3/4"	4-3/4T	31.8	22.4	71.5	19.1	51	126	1.23	
SH03022	7/8"	6-1/2T	36.6	25.4	84	22.4	58	148	1.8	
SH03025	1"	8-1/2T	42.9	28.7	95.5	25.4	68.5	167	2.78	
SH03029	1-1/8"	9-1/2T	46	31.8	108	28.7	74	190	3.75	
SH03032	1-1/4"	12T	51.5	35.1	119	31.8	82.5	210	5.31	
SH03035	1-3/8"	13-1/2T	57	38.1	133	35.1	92	233	6.98	
SH03038	1-1/2"	17T	60.5	41.4	146	38.1	98.5	254	9.4	
SH03044	1-3/4"	25T	73	51	178	44.5	127	313	15.4	
SH03050	2"	35T	82.5	57	197	51	146	348	23.7	
SH03063	2-1/2"	55T	105	70	267	66.5	184	453	39	
SH03075	3"	85T	127	82.5	330	76	200	546	70	
SH03088	3-1/2"	120T	133	95.5	372	92	229	626	120	
SH03100	4"	150T	140	108	368	104	254	653	158	

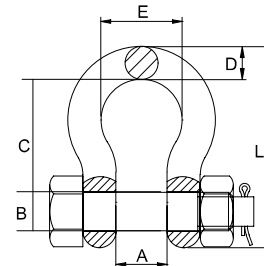

Ružna oprema za podizanje tereta

Električna oprema za podizanje tereta

Poliesterske privrznice

Transportna traka za osiguranje tereta

Lanac, farbana privrznice i komponente

Čelična užad, privrznice i komponente

Oprema za šumastvo

Oprema za premještanje tereta

ŠKOPCI

Ravni škopac ima pravolinijski oblik nogu koji je optimizovan za opterećenje u dva pravca. Najčešće se koristi na jednokrakim priveznicama (slingovima).

Kovan, kaljen i toplotno obrađen

Materijal: telo – ugljenični čelik, osovina – legirani čelik

Završna obrada: telo elektrolgalvanizovano, osovina farbana (standardno); vruće pocinkovana obrada opciono

Faktor sigurnosti: 6:1 kao standard; 4:1 opciono

Označavanje: dimenzija, WLL, «CE» oznaka, broj serije

NAPOMENA: opciono  NFC identifikacija

RAVNI ŠKOPAC TIP «A»

Šifra	Veličina	Nosivost (t)	Dimenzije (mm)						Težina kg	Product Code
			A	B	C	D	E	L		
SH02005	3/16"	1/3T	9.7	6.4	19	4.8	19.4	33.9	0.022	
SH02006	1/4"	1/2T	11.9	7.85	22.4	6.35	24.6	40.4	0.05	
SH02008	5/16"	3/4T	13.5	9.65	26.2	7.85	29.5	48.5	0.08	
SH02010	3/8"	1T	16.8	11.2	31.8	9.65	35.8	58.5	0.13	
SH02011	7/16"	1-1/2T	19.1	12.7	36.6	11.2	41.4	67.5	0.19	
SH02013	1/2"	2T	20.6	16	41.4	12.7	46	77	0.27	
SH02016	5/8"	3-1/4T	26.9	19.1	51	16	58.5	95.5	0.57	
SH02019	3/4"	4-3/4T	31.8	22.4	60.5	19.1	70	115	1.02	
SH02022	7/8"	6-1/2T	36.6	25.4	71.5	22.4	81	135	1.43	
SH02025	1"	8-1/2T	42.9	28.7	81	25.4	93.5	151	2.15	
SH02029	1-1/8"	9-1/2T	46	31.8	91	28.7	103	172	3.06	
SH02032	1-1/4"	12T	51.5	35.1	100	31.8	115	191	4.11	
SH02035	1-3/8"	13-1/2T	57	38.1	111	35.1	127	210	5.28	
SH02038	1-1/2"	17T	60.5	41.4	122	38.1	137	230	7.23	
SH02044	1-3/4"	25T	73	51	146	44.5	162	279	12.13	
SH02050	2"	35T	82.5	57	172	51	184	312	19.2	
SH02063	2-1/2"	55T	105	70	203	66.5	238	377	32.5	

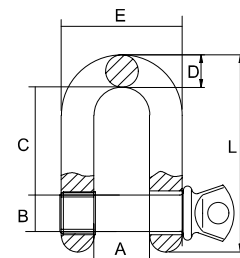

RAVNI ŠKOPAC TIP «C»

Šifra	Veličina	Nosivost (t)	Dimenzije (mm)						Težina kg	Product Code
			A	B	D	C	L	E		
SH04006	1/4"	1/2T	11.9	7.9	6.4	19.1	40.4	24.6	0.065	
SH04008	5/16"	3/4T	13.5	9.7	7.9	25.4	48.5	29.5	0.10	
SH04010	3/8"	1T	16.8	11.2	9.7	31	58.5	35.8	0.15	
SH04011	7/16"	1-1/2T	19.1	12.7	11.2	36.1	67.5	41.1	0.22	
SH04013	1/2"	2T	20.6	16	12.7	41.4	77	46	0.34	
SH04016	5/8"	3-1/4T	26.9	19.1	16	51	95.5	58.5	0.67	
SH04019	3/4"	4-3/4T	31.8	22.4	19.1	60.5	115	70	1.14	
SH04022	7/8"	6-1/2T	36.6	25.4	22.4	71.5	135	81	1.74	
SH04025	1"	8-1/2T	42.9	28.7	25.4	81	151	93.5	2.52	
SH04029	1-1/8"	9-1/2T	46	31.8	28.7	91	172	103	3.45	
SH04032	1-1/4"	12T	51.5	35.1	31.8	100	191	115	4.9	
SH04035	1-3/8"	13-1/2T	57	38.1	35.1	111	210	127	6.24	
SH04038	1-1/2"	17T	60.5	41.4	38.1	122	230	137	8.39	
SH04044	1-3/4"	25T	73	51	44.5	146	279	162	14.24	
SH04050	2"	35T	82.5	57	51	172	312	184	21.2	
SH04063	2-1/2"	55T	105	70	66.5	203	377	238	38.55	
SH04075	3"	85T	127	82.5	76	216	429	279	56.5	

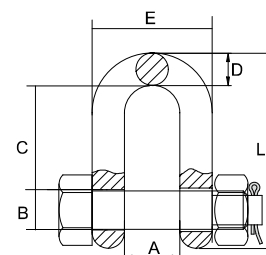

Ručna oprema za podizanje tereta

Električna oprema za podizanje tereta

Poliesterske priveznice

Transportne trake za osiguranje tereta

Lanac, lančane priveznice i komponente

Čelična užad, priveznice i komponente

Oprema za šumarstvo

Oprema za premeštanje tereta



- Za podizanje tereta.
- Kovan, kaljen i toplotno obrađen.

Materijal: legirani čelik
 Površinska obrada: prirodna boja / elektrogalvanizacija / vruće cinčanje / praškasta boja
 Probno opterećenje: 2,5 puta radno opterećenje
 Faktor sigurnosti: 5:1

NAPOMENA: opciono NFC identifikacija

ŠKOPAC TRBUŠASTI G80 - TIP «SBS»

Šifra	Veličina	Nosivost	Dimenzije (mm)					Težina kg	Product Code
			t	A	C	D	B		
8-SBS-08	5/16"	1.2	13.5	21.3	8	9.5	53	0.09	
8-SBS-10	3/8"	1.6	16.8	25.9	9.7	11	63.2	0.14	
8-SBS-11	7/16"	2.5	19	29.5	11.2	13	74	0.17	
8-SBS-13	1/2"	3.3	20.6	33.3	12.7	16	83.3	0.33	
8-SBS-16	5/8"	5	27	42.9	17.5	19	106.4	0.62	
8-SBS-19	3/4"	7	32	20.8	20.6	22	126.2	1.07	
8-SBS-22	7/8"	9.5	36.6	57.9	24.6	25	148	1.64	
8-SBS-25	1"	12.5	43	68.3	27	28	166.6	2.28	
8-SBS-28	1-1/8"	15	46	74	31.75	32	190	3.36	
8-SBS-32	1-1/4"	18	51.6	82.5	35	35	210	4.31	
8-SBS-35	1-3/8"	21	57	92	36	38	232.7	6.14	
8-SBS-38	1-1/2"	30	60.5	98	41	42	254	7.8	
8-SBS-44	1-3/4"	40	73.2	126	57.2	51	313.7	12.6	
8-SBS-50	2"	55	82.5	146	61	57	347.5	20.43	

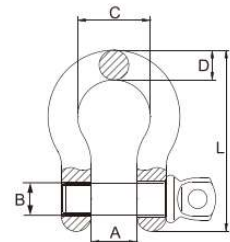

ŠKOPAC RAVNI G80 - TIP «SDS»

Šifra	Veličina	Nosivost	Dimenzije (mm)				Težina kg	Product Code
			t	A	D	L		
8-SDS-08	5/16"	1.2	13.5	8	48.5	9.5	0.08	
8-SDS-10	3/8"	1.6	16.8	9.7	58.4	11	0.13	
8-SDS-11	7/16"	2.5	19	11.2	67.6	13	0.2	
8-SDS-13	1/2"	3.3	20.6	12.7	77	16	0.27	
8-SDS-16	5/8"	5	27	17.5	97.3	19	0.57	
8-SDS-19	3/4"	7	32	20.6	116.6	22	1.19	
8-SDS-22	7/8"	9.5	36.6	24.6	135.4	25	1.43	
8-SDS-25	1"	12.5	43	27	152.4	28	2.15	
8-SDS-28	1-1/8"	15	46	31.8	172.4	32	3.06	
8-SDS-32	1-1/4"	18	51.6	35	190.5	38	4.11	
8-SDS-35	1-3/8"	21	57	35	206.8	38	5.28	
8-SDS-38	1-1/2"	30	60.5	41	230.1	42	7.23	
8-SDS-44	1-3/4"	40	73.2	53.8	279	51	12.13	
8-SDS-50	2"	55	82.5	61	324.6	57	19.19	

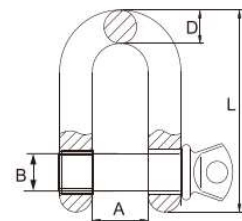

ŠKOPCI

- Za podizanje tereta.
- Kovan, kaljen i toplotno obrađen.

Materijal: legirani čelik
 Površinska obrada: prirodna boja / elektrogalvanizacija / vruće cinčanje / praškasta boja
 Probno opterećenje: 2,5 puta radno opterećenje
 Faktor sigurnosti: 5:1

NAPOMENA: opciono  NFC identifikacija

ŠKOPAC TRBUŠASTI G80 - TIP «BBS»

Šifra	Veličina	Nosivost	Dimenzije (mm)							Težina	Product Code
			t	A	C	D	L	N	L1		
8-BBS-08	5/16"	1.2	13.5	21.3	8	53	9.5	50.5	8.4	0.1	
8-BBS-10	3/8"	1.6	16.8	25.9	9.7	63.2	11	62	10.8	0.15	
8-BBS-11	7/16"	2.5	19	29.5	11.2	74	13	70	12.8	0.22	
8-BBS-13	1/2"	3.3	20.6	33.3	12.7	83.3	16	79.5	14.8	0.46	
8-BBS-16	5/8"	5	27	42.9	17.5	106.4	19	101.5	18	0.73	
8-BBS-19	3/4"	7	32	51	20.6	126.2	22	117.5	19.4	1.1	
8-BBS-22	7/8"	9.5	36.6	57.9	24.6	148	25	136	21.5	1.79	
8-BBS-25	1"	12.5	43	68.3	27	166.6	28	153.5	23.8	2.57	
8-BBS-28	1-1/8"	15	46	74	31.75	190	32	171.5	25.6	3.75	
8-BBS-32	1-1/4"	18	51.6	82.5	35	210	35	192	31	5.31	
8-BBS-35	1-3/8"	21	57	92	36	232.7	38	202	33.4	7.18	
8-BBS-38	1-1/2"	30	60.5	98	41	254	42	222	34	9.43	
8-BBS-44	1-3/4"	40	73	126	57.2	313.7	51	278	38	13.38	
8-BBS-50	2"	55	82.5	146	61	347.5	57	307	45	23.7	

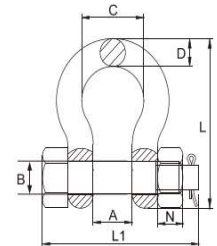

ŠKOPAC RAVNI G80 - TIP «BDS»

Šifra	Veličina	Nosivost	Dimenzije (mm)						Težina	Product Code
			t	A	D	B	L	L1		
8-BDS-08	5/16"	1.2	13.5	8	9.5	48.5	50.5	8.4	0.1	
8-BDS-10	3/8"	1.6	16.8	9.7	11	58.4	62	10.8	0.15	
8-BDS-11	7/16"	2.5	19.1	11.2	13	67.6	70	12.8	0.22	
8-BDS-13	1/2"	3.3	20.6	12.7	16	77	79.5	14.8	0.34	
8-BDS-16	5/8"	5	27	17.5	19	97.3	101.5	18	0.67	
8-BDS-19	3/4"	7	32	20.6	22	116.6	117.5	19.4	1.14	
8-BDS-22	7/8"	9.5	36.6	24.6	25	135.4	136	21.5	1.75	
8-BDS-25	1"	12.5	43	27	28	152.4	153.5	23.8	2.52	
8-BDS-28	1-1/8"	15	46	31.8	32	172.4	171.5	25.6	3.45	
8-BDS-32	1-1/4"	18	51.6	35	35	190.5	192	31	4.9	
8-BDS-35	1-3/8"	21	57	35	38	206.8	202	33.4	6.24	
8-BDS-38	1-1/2"	30	60.5	41	42	230.1	222	34	8.39	
8-BDS-44	1-3/4"	40	73	53.8	51	279	278	38	14.24	
8-BDS-50	2"	55	82.5	61	57	324.6	307	45	21.22	

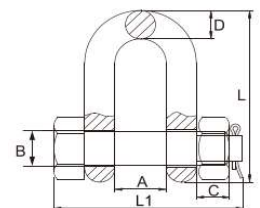

Ručna oprema za podizanje tereta
 Električna oprema za podizanje tereta
 Poliesterske privrznice
 Transportne trake za osiguranje tereta
 Lanac, lančane privrznice i komponente
 Čelična užad, privrznice i komponente
 Oprema za šumarstvo
 Oprema za premeštanje tereta

ŠKOPAC KOMERCIJALNI RAVNI TIP «A»

Šifra	Veličina	Nosivost	Dimenzije (mm)				Težina kg	Product Code
			A	B	C	D		
SH06005	5MM	0.08T	10	11	19	5	0.015	
SH06006	6MM	0.1T	13	14	25	6	0.024	
SH06008	8MM	0.2T	16	18	32	8	0.05	
SH06010	10MM	0.32T	19	20	38	10	0.085	
SH06012	12MM	0.52T	25	26	51	12	0.17	
SH06014	14MM	0.7T	28	28	56	14	0.25	
SH06016	16MM	0.8T	32	33	64	16	0.38	
SH06018	18MM	1T	36	35	72	18	0.59	
SH06020	20MM	1.1T	38	40	76	20	0.76	
SH06022	22MM	1.5T	44	50	89	22	1.05	
SH06025	25MM	2.1T	51	57	100	25	1.55	
SH06028	28MM	3T	57	68	115	28	2.25	
SH06032	32MM	3.5T	64	73	127	32	3.35	
SH06036	36MM	4T	72	75	144	36	4.6	
SH06038	38MM	5T	76	85	152	38	5.86	
SH06042	42MM	6T	84	90	168	42	7.9	
SH06045	45MM	7T	90	96	180	45	10	
SH06050	50MM	8T	102	108	200	50	12.5	

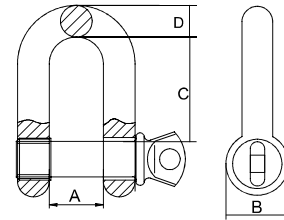

ŠKOPAC DIN 82101 TIP «A»

Oblik A: škopac sa vijkom i osovinom sa maticom
 Materijal: ugljenični čelik, kovano pod pritiskom
 Sigurnosni faktor: Minimalno opterećenje pri kidanju (MBL) je obično pet puta veće od radnog opterećenja (WLL)
 Površinska obrada: toplo pocinkovano, elektrocinkovano ili prirodna boja metala

NAPOMENA: opciono  NFC identifikacija

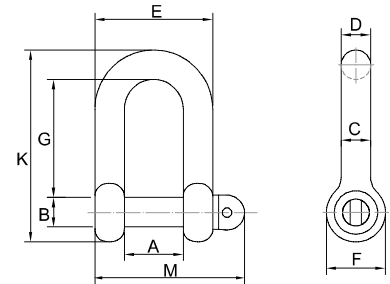

Šifra	Veličina	Nosivost (t)	Dimenzije (mm)									Težina kg	Product Code
			A	B	C	D	E	F	G	K	M		
SH07005	M5	0.1T	7	5	4	5	15	10	15	28	23	0.013	
SH07006	M6	0.16T	8	6	5	6	18	12	18	33	26.5	0.021	
SH07008	M8	0.25T	11	8	7	8	25	16	23.5	44	33.5	0.048	
SH07010	M10	0.4T	14	10	8	10	30	20	29.5	55	41	0.083	
SH07012	M12	0.6T	17	12	10	12	37	24	35.5	66	50	0.156	
SH07016	M16	1T	21	16	13	15	47	32	48.5	88	62	0.33	
SH07020	M20	1.6T	27	20	17	19	61	40	60.5	110	82	0.71	
SH07022	M22	2T	30	22	19	21	68	44	66.5	121	90	0.94	
SH07024	M24	2.5T	33	24	21	23	75	48	72.5	132	99	1.35	
SH07027	M27	3T	38	27	24	26	86	54	83	150	115	1.89	
SH07030	M30	4T	42	30	27	29	96	60	90.5	165	125	2.53	
SH07036	M36	5T	47	36	30	33	107	72	110.5	198	139	4	
SH07039	M39	6T	53	39	34	37	121	78	119	215	154.5	5.1	
SH07045	M45	8T	60	45	38	41	136	90	138.5	248	175.5	7.92	
SH07048	M48	10T	66	48	42	45	150	96	146	264	195	9.87	
SH07052	M52	12T	73	52	47	50	167	104	157	284	211	13.68	
SH07060	M60	16T	81	60	52	55	185	120	183.5	330	232	20.23	
SH07068	M68	20T	90	68	58	61	206	136	209.5	374	259	28.51	
SH07072	M72	25T	100	72	63	67	226	144	219.5	396	284	33.93	



Ručna oprema za podizanje tereta

Električna oprema za podizanje tereta

Poliesterske privezice

Transportna traka za osiguranje tereta

Lanac, lančane privezice i komponente

Čelična užad, privezice i komponente

Oprema za šumastvo

Oprema za premeštanje tereta

ŠKOPCI

ŠKOPAC DIN 82101 TIP «C»

Oblik C: Dee škopac sa sigurnosnim vijkom, maticom i osiguračem
 Materijal: ugljenični čelik, kovano pod pritiskom
 Sigurnosni faktor: Minimalno opterećenje pri kidanju (MBL) je obično pet puta veće od radnog opterećenja (WLL)
 Površinska obrada: toplo pocinkovano, electrocinkovano ili prirodna boja metala

NAPOMENA: opciono  NFC identifikacija

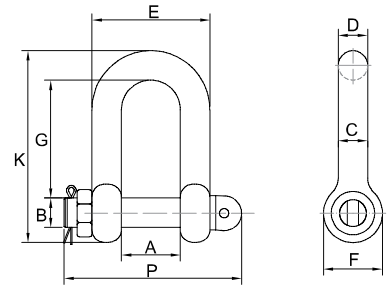

Šifra	Veličina	Nosivost (t)	Dimenzije (mm)										Težina kg	Product Code
			A	B	C	D	E	F	G	K	P			
SH08010	M10	0.4T	14	10	8	10	30	20	29.5	55	58	0.097		
SH08012	M12	0.6T	17	12	10	12	37	24	35.5	66	68	0.181		
SH08016	M16	1T	21	16	13	15	47	32	48.5	88	81	0.369		
SH08020	M20	1.6T	27	20	17	19	61	40	60.5	110	104	0.788		
SH08022	M22	2T	30	22	19	21	68	44	66.5	121	115	1.01		
SH08024	M24	2.5T	33	24	21	23	75	48	72.5	132	127	1.458		
SH08027	M27	3T	38	27	24	26	86	54	83	150	145	2.05		
SH08030	M30	4T	42	30	27	29	96	60	90.5	165	156	2.72		
SH08036	M36	5T	47	36	30	33	107	72	110.5	198	172	4.2		
SH08039	M39	6T	53	39	34	37	121	78	119	215	189	5.66		
SH08045	M45	8T	60	45	38	41	136	90	138.5	248	211	8.45		
SH08048	M48	10T	66	48	42	45	150	96	146	264	240	10.8		
SH08052	M52	12T	73	52	47	50	167	104	157	284	254	14.23		
SH08060	M60	16T	81	60	52	55	185	120	183.5	330	285	21.93		
SH08068	M68	20T	90	68	58	61	206	136	209.5	374	316	31.18		
SH08072	M72	25T	100	72	63	67	226	144	219.5	396	341	36.73		
SH08080	M80	32T	110	80	70	74	250	160	244.5	440	369	50		
SH08090	M90	40T	125	90	79	84	283	180	274	495	409	71		
SH08100	M100	50T	140	100	88	93	316	200	307	550	462	97.08		



Ručna oprema za podizanje tereta

Električna oprema za podizanje tereta

Poliesterske privrznice

Transportne trake za osiguranje tereta

Lanac, lančane privrznice i komponente

Čelična užad, privrznice i komponente

Oprema za sumarstvo

Oprema za premještanje tereta